

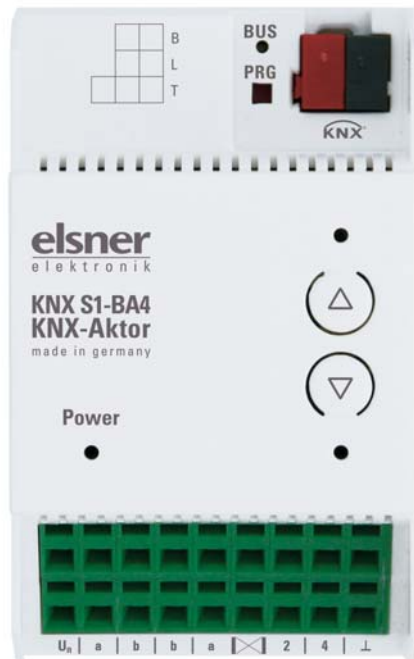

KNX S1-BA4

Multifunctional Actuator

Item number 70514



1. Description	3
1.1. Technical specification	4
2. Installation and start-up	4
2.1. Installation notes	4
2.2. Device design	5
2.3. Connection	6
2.3.1. Indication of operation mode with the Power LED	7
2.3.2. Status display by the channel LEDs	7
2.3.3. Connection examples	7
2.4. Notes on mounting and commissioning	9
3. Addressing of the device at the bus	9
4. Transfer protocol	11
4.1. List of all communication objects	11
5. Parameter setting	22
5.1. General settings	22
5.2. Output	22
5.2.1. Channel settings – drives	23
5.2.1.1. Control (drives)	25
5.2.1.2. Manual	32
5.2.1.3. Automation - external	33
5.2.1.4. Automatic - internal for shading (drives)	33
5.2.1.5. Automatic for windows (drives)	38
5.2.1.6. Scenes (drives)	42
5.2.1.7. Button inputs (drives)	42
5.2.2. Output channel with drive	48
5.2.3. Connection option for zero position sensors	50
5.2.4. Output channel with switch function	52
5.2.5. Channel settings – switch functions	52
5.2.5.1. Connection (switch functions)	53
5.2.5.2. On/Off switch delays, time switching (switch functions)	53
5.2.5.3. Blocking function (switch functions)	54
5.2.5.4. Button input (switch functions)	55
5.3. Temperature threshold values	56
5.3.1. Temperature threshold value 1, 2, 3, 4	56



Installation, inspection, commissioning and troubleshooting of the device must only be carried out by a competent electrician.

This manual is amended periodically and will be brought into line with new software releases. The change status (software version and date) can be found in the contents footer. If you have a device with a later software version, please check **www.elsner-elektronik.de** in the menu area "Service" to find out whether a more up-to-date version of the manual is available.

Clarification of signs used in this manual



Safety advice.



Safety advice for working on electrical connections, components, etc.

DANGER!

... indicates an immediately hazardous situation which will lead to death or severe injuries if it is not avoided.

WARNING!

... indicates a potentially hazardous situation which may lead to death or severe injuries if it is not avoided.

CAUTION!

... indicates a potentially hazardous situation which may lead to trivial or minor injuries if it is not avoided.



ATTENTION! ... indicates a situation which may lead to damage to property if it is not avoided.

ETS

In the ETS tables, the parameter default settings are marked by underlining.

1. Description

The **Actuator KNX S1-BA4** with integrated façade control has a multifunctional output which can connect to either a drive with Up/Down control (blinds, awnings, shutters, windows) or two switchable devices (On/Off for light and ventilation). Because the output is designed to be free of potential, other systems can also be controlled, e.g. via the manual switch input on a motor control unit.

Automation can be specified externally or internally. Internally, there are numerous options available for blocking, locking (e.g. master-slave) and priority definitions (e.g. manual-automatic). Scenes can be saved and called up via the bus (scene control with 16 scenes per drive).

The **KNX S1-BA4** has four analogue/digital inputs that are used as bus inputs (buttons, alarm messages etc.) or for temperature sensors T-NTC.

Functions:

- **Potential-free multifunctional output** each for a **230 V drive** (shade, window) or for connecting two **switchable 230 V devices** (light, fan) or for a **DC drive** (shade, window)
- In the AC voltage mode, **automatic runtime measurement** of the drives for positioning (including fault notification object)
- Switching of the relay in the AC mode with low wear near the zero-voltage
- Keypad with **button pair** and status LEDs
- **4 inputs** for binary contacts or temperature sensor
- **Position feedback** (movement position, also slat position for shutters)
- **Position storage** (movement position) via 1-bit object (storage and call-up e.g. via buttons)
- Parameters for taking drive and mechanics **downtimes** into account
- Control via **internal or external automation functions**
- Integrated **shade control** with **slat adjustment** for shutters based on the position of the sun
- **Scene control** for movement position with 16 scenes per drive (also slat position for shutters)
- Mutual **locking** of two drives using zero position sensors prevents collisions e.g. of shade and window (master-slave)
- **Blocking objects and alarm reports** have different priorities, so safety functions always take precedence (e.g. wind block)
- Manual or automatic **priority** setting via time or communication object
- **4 temperature switching outputs** in the application program with adjustable threshold values (presetting the parameters or communication object)
- **Brief time limit** (movement command blocked) and **2 movement limits**

Configuration is made using the KNX software ETS. The **product file** can be downloaded from the Elsner Elektronik website on www.elsner-elektronik.de in the "Service" menu.

1.1. Technical specification

Housing	Plastic
Colour	White
Assembly	Series installation on mounting rails
Protection category	IP 20
Dimensions	approx. 53 x 88 x 60 (W x H x D, mm), 3 width units
Weight	approx. 170 g
Ambient temperature	Operation -20...+70°C, storage -55...+90°C
Ambient humidity	max. 95% RH, non-condensing
Operating voltage	KNX bus voltage
Current at the bus	10 mA
Auxiliary voltage for output	DC voltage up to 24V DC or AC voltage up to 250V AC
Output	1 × output, free of potential with 2 connections for drive up/down or 2 devices. Can withstand a total of max. 4 A (resistive load)
Minimum current for runtime measurement	AC effective 200 mA
Inputs	4x analogue/digital, max. output length 10 m
Setting range for the T-NTC temperature sensor on the input	-30°C...+80°C
Data output	KNX +/- bus connector terminal
BCU type	Integrated microcontroller
PEI type	0
Group addresses	max. 1024
Assignments	max. 1024
Communication objects	200

The product is compliant with the provisions of EU guidelines.

2. Installation and start-up

2.1. Installation notes



Installation, testing, operational start-up and troubleshooting should only be performed by an electrician.



DANGER!

Risk to life from live voltage (mains voltage)!

There are unprotected live components within the device.

- VDE regulations and national regulations are to be followed.

- Ensure that all lines to be assembled are free of voltage and take precautions against accidental switching on.
 - Do not use the device if it is damaged.
 - Take the device or system out of service and secure it against unintentional use, if it can be assumed, that risk-free operation is no longer guaranteed.
-

The device is only to be used for its intended purpose. Any improper modification or failure to follow the operating instructions voids any and all warranty and guarantee claims.

After unpacking the device, check it immediately for possible mechanical damage. If it has been damaged in transport, inform the supplier immediately.

The device may only be used as a fixed-site installation; that means only when assembled and after conclusion of all installation and operational start-up tasks and only in the surroundings designated for it.

Elsner Elektronik is not liable for any changes in norms and standards which may occur after publication of these operating instructions.

2.2. Device design



Follow the guidelines and standards for SELV electric circuits while installing and cable laying of the KNX connection (no. 2) and inputs (no. 7).

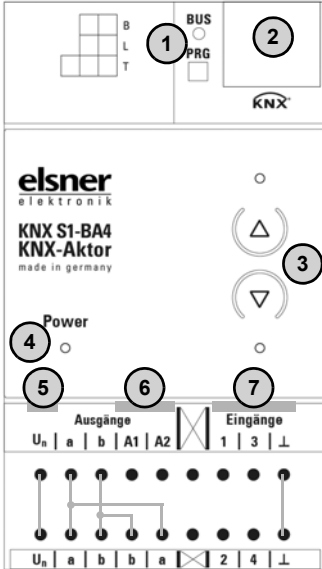

Fig. 1

- 1) Programming LED and button (PRG)
- 2) Bus terminal slot (KNX +/-)
- 3) Up/Down button pair and LEDs
- 4) LED "Operation" (Power), display of operating status, see "Indication of operation mode with the Power LED" on page 7.
- 5) Input auxiliary voltage U_n for outputs A1/A2.
Load capacity: maximum 4 A.
a/b connections for use with a connection of 230 V AC.
- 6) Output A1 - A2:
"Up" "Down" or "Device 1" "Device 2"
- 7) Analogue/Binary inputs 1-4 (with GND)

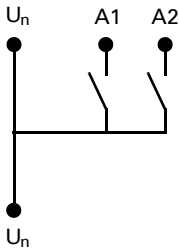

Fig. 2

Circuit diagram output (A1, A2) with voltage supply (U_n)

2.3. Connection

The device is designed for series installation on mounting rails and occupies 6 units. The connection is made using a KNX connector on the KNX data bus. In addition, a power supply for the connected drive or consumer is necessary (U_n).



ATTENTION!

Relays may be switched on when starting the device for the first time!

The bistable relays used in this product may switch on in case of shock, e. g. during transportation.

- First apply the bus voltage, as this will switch off the relays. Then switch on the voltage supply of the drive.

2.3.1. Indication of operation mode with the Power LED

Behaviour	Colour	
On	Green	Normal operation. Bus connection/bus voltage available.
Flashes	Green	Normal operation. No bus connection/bus voltage available.
On	Orange	Device starts up or is being programmed via the ETS. No automatic functions are executed.
Flashes	Green (on), Orange (flashing)	Programming mode active.

2.3.2. Status display by the channel LEDs

Behaviour	LED	
To	top	Drive in top end position/device on.
To	bottom	Drive in bottom end position/drive on.
Flashes slowly	top	Drive moves up.
Flashes slowly	bottom	Drive moves down.
Flashes quickly	top	Drive in top end position, blocking active.
Flashes quickly	bottom	Drive in bottom position, blocking active.
Flashes quickly	both simultaneously	Drive in intermediate position, blocking active.
Extend	both	Drive in intermediate position.
Flashes	both alternately	Automatic runtime determination error. If the drive can be moved, drive it into the end position by hand (drive in/drive out completely or open/close) in order to restart the runtime determination. If the drive cannot be moved, check the connections.
"Runlight" above all LEDs	all channels	Incorrect application version was loaded. Use the version compatible with the device!

2.3.3. Connection examples

Due to the potential output, the **Actuator KNX S1-BA4** is equally suitable for use with AC (230 V AC) and DC (12 V DC, 24 V DC).

230 V drive at the output:

In this case, the “ U_n ” connection is used as “L”. The terminals “a” and “b” are used as “N” and “PE” as shown in the connection example.

Fig. 3

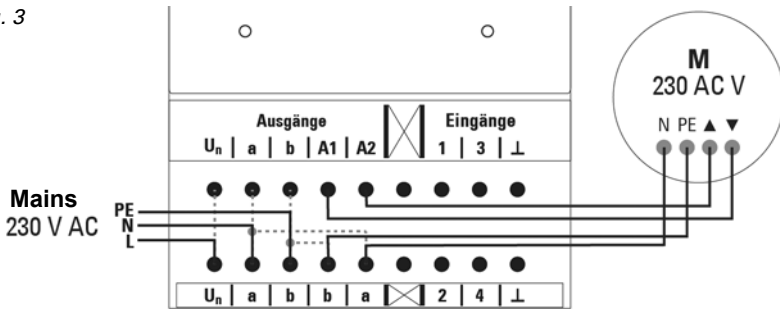
**Two 230V consumers at the output:**

In this case, the “ U_n ” connection is used as “L”. The terminals “a” and “b” are used as “N” and “PE” as shown in the connection example.

Fig. 4

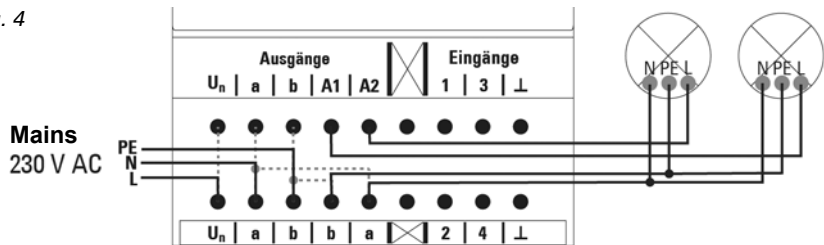
**24 V DC drive at the output:**

In this case, the “ U_n ” connection is used as “+”. An automatic runtime measurement is not possible with a DC voltage supply!

Fig. 5

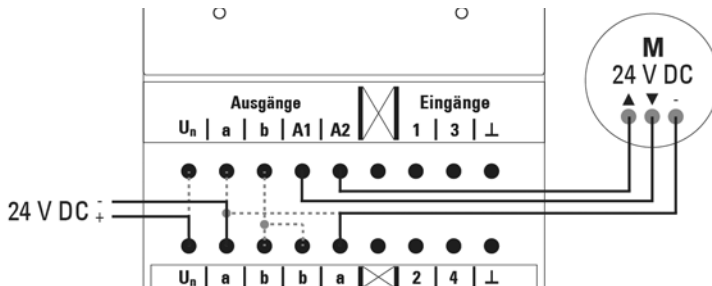

Control of an external motor control unit via the output:

Fig. 6

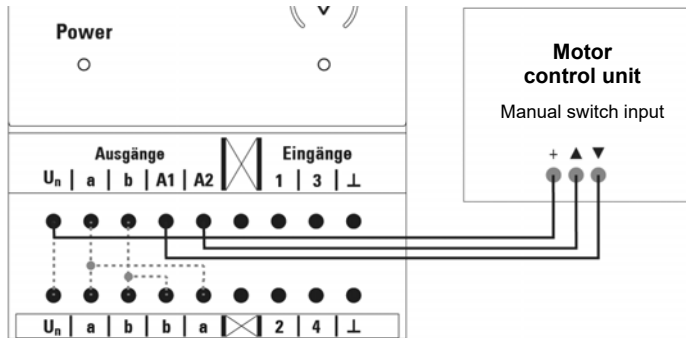

Inputs:

Example with a binary contact in input 1 and temperature sensor T-NTC at input 4. The connection of the temperature sensor is independent of the polarity.

Fig. 7

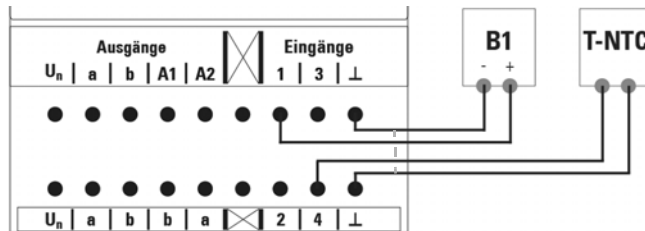

2.4. Notes on mounting and commissioning

Device must not be exposed to water (rain). This could result in the electronic being damaged. A relative air humidity of 95% must not be exceeded. Avoid bedewing.

After the operating voltage has been applied, the device will enter an initialisation phase lasting a few seconds. During this phase no information can be received or sent via the bus.

For KNX devices with safety functions (e.g. wind or rain blocks), it is important to set up periodical monitoring of the safety objects. The optimal ratio is 1:3 (example: if the weather station sends a value every 5 minutes, the actuator must be configured for a monitoring period of 15 minutes).

3. Addressing of the device at the bus

The device is supplied with the bus address 15.15.250. You can program another address into the ETS by overwriting the 15.15.250 address or by teaching via the programming key.

4. Transfer protocol

4.1. List of all communication objects

Abbreviations:

R Read

W Write

C Communication

T Transfer

No	Text	Function	Flags	Data Point Type	Size
1	Software version	Readable	R-C-	[217.1] DPT_Version	2 Bytes
100	Channel A status automatic or manual	Output	R-CT	[1] 1.xxx	1 Bit
101	Channel A manual long term	Input	RWC-	[1.8] DPT_UpDown	1 Bit
102	Channel A manual short term	Input	RWC-	[1.8] DPT_UpDown	1 Bit
103	Channel A manual movement position	Input	RWC-	[5.1] DPT_Scaling	1 Byte
104	Channel A manual slat position	Input	RWC-	[5.1] DPT_Scaling	1 Byte
105	Channel A automatic long term	Input	RWC-	[1.8] DPT_UpDown	1 Bit
106	Channel A automatic short term	Input	RWC-	[1.8] DPT_UpDown	1 Bit
107	Channel A automatic movement position	Input	RWC-	[5.1] DPT_Scaling	1 Byte
108	Channel A automatic slat position	Input	RWC-	[5.1] DPT_Scaling	1 Byte
109	Channel A switch from manual to automatic	Input	RWC-	[1] 1.xxx	1 Bit
110	Channel A automatic blocking object	Input	RWC-	[1.1] DPT_Switch	1 Bit
111	Channel A current movement position	Output	R-CT	[5.1] DPT_Scaling	1 Byte
112	Channel A current slat position	Output	R-CT	[5.1] DPT_Scaling	1 Byte
113	Channel A status object	Output	R-CT	[1] 1.xxx	1 Bit
114	Channel A - Approach position memory manually	Input	RWC-	[1.1] DPT_Switch	1 Bit
115	Channel A - Learn object 0 position memory manually	Input	RWC-	[1.1] DPT_Switch	1 Bit

No	Text	Function	Flags	Data Point Type	Size
116	Channel A - Learn object 1 position memory manually	Input	RWC-	[1.1] DPT_Switch	1 Bit
119	Channel A - Approach position memory automatically	Input	RWC-	[1.1] DPT_Switch	1 Bit
120	Channel A - Learn object 0 position memory automatically	Input	RWC-	[1.1] DPT_Switch	1 Bit
121	Channel A - Learn object 1 position memory automatically	Input	RWC-	[1.1] DPT_Switch	1 Bit
124	Channel A call saving scenes	Input	RWC-	[18.1] DPT_SceneControl	1 Byte
125	Channel A outdoor temperature Blocking object	Input	RWC-	[1.1] DPT_Switch	1 Bit
126	Channel A outdoor temperature blocking measurement value	Input	RWC-	[9.1] DPT_Value_Temp	2 Bytes
127	Channel A outdoor temperature blocking status	Output	R-CT	[1.1] DPT_Switch	1 Bit
128	Channel A twilight object	Input	RWC-	[1.1] DPT_Switch	1 Bit
129	Channel A twilight measurement value	Input	RWC-	[9.4] DPT_Value_Lux	2 Bytes
130	Channel A twilight status	Output	R-CT	[1.1] DPT_Switch	1 Bit
131	Channel A time control	Input	RWC-	[1.1] DPT_Switch	1 Bit
132	Channel A inside temperature release object	Input	RWC-	[1.1] DPT_Switch	1 Bit
133	Channel A inside temperature release measurement value	Input	RWC-	[9.1] DPT_Value_Temp	2 Bytes
134	Channel A inside temperature release target value	Input	RWC-	[9.1] DPT_Value_Temp	2 Bytes
135	Channel A inside temperature release status	Output	R-CT	[1.1] DPT_Switch	1 Bit
136	Channel A shading object	Input	RWC-	[1.1] DPT_Switch	1 Bit
137	Channel A shading brightness Measurement value 1	Input	RWC-	[9.4] DPT_Value_Lux	2 Bytes

No	Text	Function	Flags	Data Point Type	Size
138	Channel A shading brightness Measurement value 2	Input	RWC-	[9.4] DPT_Value_Lux	2 Bytes
139	Channel A shading brightness Measurement value 3	Input	RWC-	[9.4] DPT_Value_Lux	2 Bytes
140	Channel A shading threshold value	Input / output	RWCT	[9.4] DPT_Value_Lux	2 Bytes
141	Channel A shading threshold value 1 = + 0 = -	Input	RWC-	[1] 1.xxx	1 Bit
142	Channel A shading threshold value +	Input	RWC-	[1] 1.xxx	1 Bit
143	Channel A shading threshold value -	Input	RWC-	[1] 1.xxx	1 Bit
144	Channel A shading status	Output	R-CT	[1.1] DPT_Switch	1 Bit
145	Channel A shading position Teaching object	Input	RWC-	[1] 1.xxx	1 Bit
146	Channel A azimuth	Input	RWC-	[9] 9.xxx	2 Bytes
147	Channel A elevation	Input	RWC-	[9] 9.xxx	2 Bytes
148	Channel A cold air supply blocking object	Input	RWC-	[1.1] DPT_Switch	1 Bit
149	Channel A cold air supply outside temperature measurement value	Input	RWC-	[9.1] DPT_Value_Temp	2 Bytes
150	Channel A cold supply air blocking status	Output	R-CT	[1.1] DPT_Switch	1 Bit
151	Channel A forced ventilation	Input	RWC-	[1.1] DPT_Switch	1 Bit
152	Channel A warm air supply blocking object	Input	RWC-	[1.1] DPT_Switch	1 Bit
153	Channel A warm air supply inside temperature measurement value	Input	RWC-	[9.1] DPT_Value_Temp	2 Bytes
154	Channel A warm air supply outside temperature measurement value	Input	RWC-	[9.1] DPT_Value_Temp	2 Bytes
155	Channel A warm air supply blocking target value	Input	RWC-	[9.1] DPT_Value_Temp	2 Bytes
156	Channel A warm air supply blocking status	Output	R-CT	[1.1] DPT_Switch	1 Bit
157	Channel A inside temperature opening object	Input	RWC-	[1.1] DPT_Switch	1 Bit

No	Text	Function	Flags	Data Point Type	Size
158	Channel A inside temperature opening measurement value	Input	RWC-	[9.1] DPT_Value_Temp	2 Bytes
159	Channel A inside temperature opening target value	Input	RWC-	[9.1] DPT_Value_Temp	2 Bytes
160	Channel A inside temperature opening threshold value	Input / output	RWCT	[9.1] DPT_Value_Temp	2 Bytes
161	Channel A inside temperature opening threshold value 1 = +	Input	RWC-	[1] 1.xxx	1 Bit
162	Channel A inside temperature opening threshold value +	Input	RWC-	[1] 1.xxx	1 Bit
163	Channel A inside temperature opening threshold value -	Input	RWC-	[1] 1.xxx	1 Bit
164	Channel A inside temperature opening status	Output	R-CT	[1.1] DPT_Switch	1 Bit
165	Channel A inside humidity opening object	Input	RWC-	[1.1] DPT_Switch	1 Bit
166	Channel A inside humidity opening Measurement value	Input	RWC-	[9.7] DPT_Value_Humidity	2 Bytes
167	Channel A inside humidity opening status	Output	R-CT	[1.1] DPT_Switch	1 Bit
170	Channel A zero position reached	Input	RWC-	[1.1] DPT_Switch	1 Bit
171	Channel A zero position sensor malfunctioning	Output	R-CT	[1.1] DPT_Switch	1 Bit
172	Channel A master zero position status	Output	R-CT	[1.1] DPT_Switch	1 Bit
173	Channel A master zero position command	Output	R-CT	[1.1] DPT_Switch	1 Bit
174	Channel A slave zero position status	Input	RWC-	[1.1] DPT_Switch	1 Bit
175	Channel A master zero position status	Input	RWC-	[1.1] DPT_Switch	1 Bit
176	Channel A master zero position command	Input	RWC-	[1.1] DPT_Switch	1 Bit
177	Channel A slave zero position status	Output	R-CT	[1.1] DPT_Switch	1 Bit
178	Channel A drive moving	Output	R-CT	[1] 1.xxx	1 Bit

No	Text	Function	Flags	Data Point Type	Size
179	Channel A malfunction object	Output	R-CT	[1] 1.xxx	1 Bit
180	Channel A block 1 blocking object	Input	RWC-	[1.1] DPT_Switch	1 Bit
181	Channel A block 1 wind blocking object	Input	RWC-	[1.1] DPT_Switch	1 Bit
182	Channel A block 1 wind blocking Measurement value	Input	RWC-	[9.5] DPT_Value_Wsp	2 Bytes
183	Channel A block 1 wind blocking status	Output	R-CT	[1.1] DPT_Switch	1 Bit
184	Channel A block 1 rain blocking object	Input	RWC-	[1.1] DPT_Switch	1 Bit
185	Channel A block 2 blocking object	Input	RWC-	[1.1] DPT_Switch	1 Bit
186	Channel A block 2 wind blocking object	Input	RWC-	[1.1] DPT_Switch	1 Bit
187	Channel A block 2 wind blocking object	Input	RWC-	[9.5] DPT_Value_Wsp	2 Bytes
188	Channel A block 2 wind blocking Measurement value	Input	R-CT	[1.1] DPT_Switch	1 Bit
189	Channel A block 2 wind blocking status	Output	RWC-	[1.1] DPT_Switch	1 Bit
190	Channel A block 2 rain blocking object	Input	RWC-	[1.1] DPT_Switch	1 Bit
191	Channel A block 3 blocking object	Input	RWC-	[1.1] DPT_Switch	1 Bit
192	Channel A block 3 wind blocking object	Input	RWC-	[9.5] DPT_Value_Wsp	2 Bytes
193	Channel A block 3 wind blocking Measurement value	Input	R-CT	[1.1] DPT_Switch	1 Bit
194	Channel A block 3 wind blocking status	Output	RWC-	[1.1] DPT_Switch	1 Bit
195	Channel A block 3 rain blocking object	Input	RWC-	[1.1] DPT_Switch	1 Bit
196	Channel A block 4 blocking object	Input	RWC-	[1.1] DPT_Switch	1 Bit
197	Channel A block 4 wind blocking object	Input	RWC-	[9.5] DPT_Value_Wsp	2 Bytes
198	Channel A block 4 wind blocking Measurement value	Input	R-CT	[1.1] DPT_Switch	1 Bit

No	Text	Function	Flags	Data Point Type	Size
199	Channel A block 4 wind blocking status	Output	RWC-	[1.1] DPT_Switch	1 Bit
200	Channel A block 4 rain blocking object	Input	RWC-	[1.1] DPT_Switch	1 Bit
201	Channel A block 5 blocking object	Input	RWC-	[1.1] DPT_Switch	1 Bit
202	Channel A block 5 wind blocking Measurement value	Input	RWC-	[9.5] DPT_Value_Wsp	2 Bytes
203	Channel A block 5 wind blocking status	Output	R-CT	[1.1] DPT_Switch	1 Bit
204	Channel A block 5 rain blocking object	Input	RWC-	[1.1] DPT_Switch	1 Bit
205	Channel A - Movement limitation 1 - blocking object	Input	RWC-	[1.1] DPT_Switch	1 Bit
206	Channel A - Movement limitation 2 - blocking object	Input	RWC-	[1.1] DPT_Switch	1 Bit
207	Channel A - Short time restriction	Input	RWC-	[1.1] DPT_Switch	1 Bit
210	Channel A1 - switching	Input	RWC-	[1.1] DPT_Switch	1 Bit
211	Channel A1 - feedback	Output	R-CT	[1.1] DPT_Switch	1 Bit
212	Channel A1 - status	Readable	R-C-	[1.1] DPT_Switch	1 Bit
213	Channel A1 - blocking object	Input	RWC-	[1.1] DPT_Switch	1 Bit
215	Channel A1 start stair case light function	Input	-WC-	[1.10] DPT_Start	1 Bit
216	Channel A1 start stop stair case light function	Input	RWC-	[1.10] DPT_Start	1 Bit
217	Channel A1 connection	Input	RWC-	[1.2] DPT_Bool	1 Bit
218	Channel A1 - Call up / saving scenes	Input	RWC-	[18.1] DPT_SceneControl	1 Byte
220	Channel A2 switching	Input	RWC-	[1.1] DPT_Switch	1 Bit
221	Channel A2 feedback	Output	R-CT	[1.1] DPT_Switch	1 Bit
222	Channel A2 status	Readable	R-C-	[1.1] DPT_Switch	1 Bit
223	Channel A2 blocking object	Input	RWC-	[1.1] DPT_Switch	1 Bit

No	Text	Function	Flags	Data Point Type	Size
225	Channel A2 start stair case light function	Input	-WC-	[1.10] DPT_Start	1 Bit
226	Channel A2 start stop stair case light function	Input	RWC-	[1.10] DPT_Start	1 Bit
227	Channel A2 connection	Input	RWC-	[1.2] DPT_Bool	1 Bit
228	Channel A2 - Call up / saving scenes	Input	RWC-	[18.1] DPT_SceneControl	1 Byte
249	Channel A - local operation blocking object	Input	RWC-	[1.1] DPT_Switch	1 Bit
250	Input 1 long term	Input / output	RWCT	[1.8] DPT_UpDown	1 Bit
251	Input 1 short term	Output	R-CT	[1.8] DPT_UpDown	1 Bit
252	Input 1 switching	Input / output	RWCT	[1.1] DPT_Switch	1 Bit
253	Input 1 dim relative	Input / output	RWCT	[3.7] DPT_Control_Dimmin g	4 Bit
254	Input 1 encoder 8 bit	Output	R-CT	[5] 5.xxx	1 Byte
255	Input 1 encoder temperature	Output	R-CT	[9.1] DPT_Value_Temp	2 Bytes
256	Input 1 encoder brightness	Output	R-CT	[9.4] DPT_Value_Lux	2 Bytes
257	Input 1 scene	Output	R-CT	[18.1] DPT_SceneControl	1 Byte
258	Input 1 blocking object	Input	RWC-	[1.1] DPT_Switch	1 Bit
260	Input 1 - Temperature sensor malfunction	Output	--CT	[1.1] DPT_Switch	1 Bit
261	Input 1 - Temperature sensor total value	Output	R-CT	[9.1] DPT_Value_Temp	2 Bytes
262	Input 1 - Temperature sensor measured value external	Input	-WC-	[9.1] DPT_Value_Temp	2 Bytes
263	Input 1 - Temperature sensor measured value	Output	R-CT	[9.1] DPT_Value_Temp	2 Bytes
270	Input 2 long term	Input / output	RWCT	[1.8] DPT_UpDown	1 Bit
271	Input 2 short term	Output	R-CT	[1.8] DPT_UpDown	1 Bit
272	Input 2 switching	Input / output	RWCT	[1.1] DPT_Switch	1 Bit

No	Text	Function	Flags	Data Point Type	Size
273	Input 2 dim relative	Input / output	RWCT	[3.7] DPT_Control_Dimmin g	4 Bit
274	Input 2 encoder 8 bit	Output	R-CT	[5] 5.xxx	1 Byte
275	Input 2 encoder temperature	Output	R-CT	[9.1] DPT_Value_Temp	2 Bytes
276	Input 2 encoder brightness	Output	R-CT	[9.4] DPT_Value_Lux	2 Bytes
277	Input 2 scene	Output	R-CT	[18.1] DPT_SceneControl	1 Byte
278	Input 2 blocking object	Input	RWC-	[1.1] DPT_Switch	1 Bit
280	Input 2 - Temperature sensor malfunction	Output	--CT	[1.1] DPT_Switch	1 Bit
281	Input 2 - Temperature sensor total value	Output	R-CT	[9.1] DPT_Value_Temp	2 Bytes
282	Input 2 - Temperature sensor measured value external	Input	-WC-	[9.1] DPT_Value_Temp	2 Bytes
283	Input 2 - Temperature sensor measured value	Output	R-CT	[9.1] DPT_Value_Temp	2 Bytes
300	Input 3 - Temperature sensor malfunction	Output	--CT	[1.1] DPT_Switch	1 Bit
301	Input 3 - Temperature sensor total value	Output	R-CT	[9.1] DPT_Value_Temp	2 Bytes
302	Input 3 - Temperature sensor measured value external	Input	-WC-	[9.1] DPT_Value_Temp	2 Bytes
303	Input 3 - Temperature sensor measured value	Output	R-CT	[9.1] DPT_Value_Temp	2 Bytes
320	Input 4 - Temperature sensor malfunction	Output	--CT	[1.1] DPT_Switch	1 Bit
321	Input 4 - Temperature sensor total value	Output	R-CT	[9.1] DPT_Value_Temp	2 Bytes
322	Input 4 - Temperature sensor measured value external	Input	-WC-	[9.1] DPT_Value_Temp	2 Bytes
323	Input 4 - Temperature sensor measured value	Output	R-CT	[9.1] DPT_Value_Temp	2 Bytes
450	Input 3 long term	Input / output	RWCT	[1.8] DPT_UpDown	1 Bit
451	Input 3 short term	Output	R-CT	[1.8] DPT_UpDown	1 Bit

No	Text	Function	Flags	Data Point Type	Size
452	Input 3 switching	Input / output	RWCT	[1.1] DPT_Switch	1 Bit
453	Input 3 dim relative	Input / output	RWCT	[3.7] DPT_Control_Dimmin g	4 Bit
454	Input 3 encoder 8 bit	Output	R-CT	[5] 5.xxx	1 Byte
455	Input 3 encoder temperature	Output	R-CT	[9.1] DPT_Value_Temp	2 Bytes
456	Input 3 encoder brightness	Output	R-CT	[9.4] DPT_Value_Lux	2 Bytes
457	Input 3 scene	Output	R-CT	[18.1] DPT_SceneControl	1 Byte
458	Input 3 blocking object	Input	RWC-	[1.1] DPT_Switch	1 Bit
470	Input 4 long term	Input / output	RWCT	[1.8] DPT_UpDown	1 Bit
471	Input 4 short term	Output	R-CT	[1.8] DPT_UpDown	1 Bit
472	Input 4 switching	Input / output	RWCT	[1.1] DPT_Switch	1 Bit
473	Input 4 dim relative	Input / output	RWCT	[3.7] DPT_Control_Dimmin g	4 Bit
474	Input 4 encoder 8 bit	Output	R-CT	[5] 5.xxx	1 Byte
475	Input 4 encoder temperature	Output	R-CT	[9.1] DPT_Value_Temp	2 Bytes
476	Input 4 encoder brightness	Output	R-CT	[9.4] DPT_Value_Lux	2 Bytes
477	Input 4 scene	Output	R-CT	[18.1] DPT_SceneControl	1 Byte
478	Input 4 blocking object	Input	RWC-	[1.1] DPT_Switch	1 Bit
500	Temp. threshold value 1: Measured value	Input	-WC-	[1.1] DPT_Switch	1 Bit
501	Temp. threshold value 1: Absolute value	Input	-WC-	[7] 7.xxx	2 Bytes
502	Temp. threshold value 1: (1:+ 0:-)	Input	-WC-	[7] 7.xxx	2 Bytes
503	Temp. threshold value 1: Switching delay from 0 to 1	Input	R-CT	[1.1] DPT_Switch	1 Bit
504	Temp. threshold value 1: Switching delay from 1 to 0	Input	-WC-	[1.1] DPT_Switch	1 Bit

No	Text	Function	Flags	Data Point Type	Size
505	Temp. threshold value 1: Switching output	Input	-SWC-	[9.1] DPT_Value_Temp	2 Bytes
506	Temp. threshold value 1: Switching output block	Input/ Output	RWCT	[9.1] DPT_Value_Temp	2 Bytes
507	Temp. threshold value 2: Measured value	Input	-WC-	[1.1] DPT_Switch	1 Bit
508	Temp. threshold value 2: Absolute value	Input	-WC-	[7] 7.xxx	2 Bytes
509	Temp. threshold value 2: (1:+ 0:-)	Input	-WC-	[7] 7.xxx	2 Bytes
510	Temp. threshold value 2: Switching delay from 0 to 1	Output	R-CT	[1.1] DPT_Switch	1 Bit
511	Temp. threshold value 2: Switching delay from 1 to 0	Input	-WC-	[1.1] DPT_Switch	1 Bit
512	Temp. threshold value 2: Switching output	Input	-WC-	[9.1] DPT_Value_Temp	2 Bytes
513	Temp. threshold value 2: Switching output block	Input/ Output	RWCT	[9.1] DPT_Value_Temp	2 Bytes
514	Temp. threshold value 3: Measured value	Input	-WC-	[1.1] DPT_Switch	1 Bit
515	Temp. threshold value 3: Absolute value	Input	-WC-	[7] 7.xxx	2 Bytes
516	Temp. threshold value 3: (1:+ 0:-)	Input	-WC-	[7] 7.xxx	2 Bytes
517	Temp. threshold value 3: Switching delay from 0 to 1	Output	R-CT	[1.1] DPT_Switch	1 Bit
518	Temp. threshold value 3: Switching delay from 1 to 0	Input	-WC-	[1.1] DPT_Switch	1 Bit
519	Temp. threshold value 3: Switching output	Input	-WC-	[9.1] DPT_Value_Temp	2 Bytes
520	Temp. threshold value 3: Switching output block	Input/ Output	RWCT	[9.1] DPT_Value_Temp	2 Bytes
521	Temp. threshold value 4: Measured value	Input	-WC-	[1.1] DPT_Switch	1 Bit
522	Temp. threshold value 4: Absolute value	Input	-WC-	[7] 7.xxx	2 Bytes
523	Temp. threshold value 4: (1:+ 0:-)	Input	-WC-	[7] 7.xxx	2 Bytes
524	Temp. threshold value 4: Switching delay from 0 to 1	Output	R-CT	[1.1] DPT_Switch	1 Bit

No	Text	Function	Flags	Data Point Type	Size
525	Temp. threshold value 4: Switching delay from 1 to 0	Input	-WC-	[1.1] DPT_Switch	1 Bit
526	Temp. threshold value 4: Switching output	Output	R-CT	[1.1] DPT_Switch	1 Bit
527	Temp. threshold value 4: Switching output block	Input	-WC-	[1.1] DPT_Switch	1 Bit

5. Parameter setting

The default settings of the parameter are labelled by an underscore.

5.1. General settings

First set the general parameters for the bus communication (telegram rate, transmission delay). Additionally, you can indicate if for the programming of scenes all, or only the changed settings are applied to the bus.

Maximum telegram rate	1 • 2 • <u>5</u> • 10 • 20 telegrams per second
Send delay of threshold values after voltage returns	<u>5 s</u> ... 2 h
Send delay of switching and status outputs after voltage returns	<u>5 s</u> ... 2 h
For the use of scenes:	
Application when programming	<u>all parameters</u> • only changed parameters

5.2. Output

State here what is connected to the output channel.

Operating mode	
Channel A controls	<ul style="list-style-type: none"> • <u>shutter</u> • blind • awning • window • double switch function

Thereafter, the setting options will appear:

Settings for drives (channel A):

- General specifications for the connected drive (see *Channel settings – drives*, page 23)
- Control functions: Movement range limit, blocking, type of automatic (see *Control (drives)*, page 25)
- Automatic functions: Automatic can be specified externally or internally (see *Movement limits*, page 32 or *Automatic for windows (drives)*, page 38)
- Scenes: Movement positions (see *Scenes (drives)*, page 42)
- Button inputs: Configuration as actuator button, bust button or for zero position sensor (see *Button inputs (drives)*, page 42)

Settings for switch functions

(Channels are divided into two switches A1/A2):

- General specifications for the switch function (see *Channel settings – switch functions*, page 52)
- Connecting different communication objects (see *Connection (switch functions)*, page 53)

- On/Off switch delays or time switching
(see *On/Off switch delays, time switching (switch functions)*, page 53)
- Block function(see *Blocking function (switch functions)*, page 54)
- Button input: Configuration as actuator button or bus button
(see *Button input (switch functions)*, page 55)

5.2.1. Channel settings – drives

If a drive is connected to the output channel, set first the general specifications for the drive.

Driving direction:

Up/down, on/off or open/close can be exchanged.

Exchange UP/DOWN (<i>shutter, blinds</i>)	<u>no</u> • yes
Exchange ON/OFF (<i>awning</i>)	
Exchange OPEN/CLOSE (<i>window</i>)	

Runtime:

The runtime between the end positions is the basis for moving into intermediate positions (e.g. for movement range limits and scenes). You can enter the runtime numerically (in seconds) or have the runtime determined automatically. The actuator specifies the end positions with help from the greater current on the drive output. For this, regular reference movements (see below) should be set.

Use an automatic runtime measurement	<u>no</u> • yes
Use an automatic runtime measurement	no
Runtime DOWN in sec (<i>shutter, blinds</i>)	1 ... 320; <u>60</u>
Runtime OFF in sec (<i>awning</i>)	
Runtime UP in sec (<i>window</i>)	
Runtime OPEN in sec (<i>shutter, blinds</i>)	1 ... 320; <u>65</u>
Runtime ON in sec (<i>awning</i>)	
Runtime CLOSE in sec (<i>window</i>)	

If a dead time is observed while starting the curtain, then this can be entered manually at this point or calculated automatically. Obey the manufacturer's instructions for the curtain.

Use dead times	<ul style="list-style-type: none"> • <u>no</u> • yes, enter by hand • yes, calculate automatically
during the position travel from closed position in 10 ms (<i>only for manual input</i>)	<u>0</u> ... 600
for position movement from all other positions in 10 ms (<i>only for manual input</i>)	<u>0</u> ... 600
for slat movement from closed position in 10 ms (<i>only for manual input</i>)	<u>0</u> ... 600

for movement with change of direction in 10 ms (<i>only for manual input</i>)	<u>0</u> ... 600
for slat movement from all other positions in 10 ms (<i>only for manual input</i>)	<u>0</u> ... 600

Runtime zero position and step setting of slats:

(*only for shutters*)

Through the runtime in which the drive continues moving in the zero position (i.e. after reaching the top end position), different curtain lengths or assembly positions of the end position switch may be balanced. The shading of a facade is completely retracted by adjusting the zero position runtimes, and thus provides a better overall image.

Step time x step number determines the turning time of the slats.

Runtime zero position in 0.1 sec	<u>0</u> ... 255
Step time in 10 ms	1 ... 100; <u>20</u>
Step number slats	1 ... 255; <u>5</u>

If the short time command for shutters (step command) is used only for slat adjustment, but not for positioning the curtain, the following parameter is set to "Yes". The parameter appears only for shutters.

Allow step commands only for slat adjustment	<u>no</u> • yes
--	-----------------

Break time:

The required break times during a change of direction of the drive should be adjusted according to the specifications of the motor manufacturer.

Break time for a change of direction in 0.1 sec	5 ... 100; <u>10</u>
---	----------------------

Reference movement:

With the regular movement to the two end positions, the runtime and zero position are adjusted again. This is especially important for the automatic runtime determination. Therefore, it can be set here after how many movements before a positioning movement a reference movement will be performed. The reference movement is always in the direction of the secure position (retracting when shading, closing windows).

Perform a reference movement	<u>no</u> • yes
Perform a reference movement for more than movements before an auto positioning movement	yes 1 ... 255; <u>10</u>

Slat turning:*(only for shutters)*

The slat turning should be adjusted according to the specifications of the motor manufacturer.

Turn slats	<ul style="list-style-type: none"> • <u>never</u> • only after positioning movement • after each movement
------------	--

Status object and drive position:

The status and current position can be sent to the bus. By sending of 1, the status object indicates that the retracted or closed position has been exited and it is suitable for example for monitoring windows.

The exact drive position can be sent on the bus if required. The variable delay ensures that the bus is not blocked by too many data packets during a longer movement. The position can also be transmitted cyclically.

Use status object	<u>no</u> • yes
Use drive position feedback	<u>no</u> • yes
Position transmit delay after change in 0.1 s <i>(only for feedback)</i>	0...50; <u>10</u>
Transmit drive position cyclically <i>(only for feedback)</i>	<u>no</u> • 5 s • 10 s • ... • 2 h

Scenes:

Here the scene menu is activated for this output channel.

Use scenes	<u>no</u> • yes
------------	-----------------

See *Scenes*; page 25.

5.2.1.1. Control (drives)

Set the behaviour of the drive here.

Movement range limit:

The operating range limit is used in order to avoid that two units collide with each other (e.g. an awning and a window which is about to open).

One of two drive mechanisms is prioritised and is parameterised as master and the other one as slave. By means of zero position sensors, both actuators know the own current status and the current status of the other one. This one is either “in a safe position” or “not in a safe position”. The safe position is reached as soon as the drive mechanism is in a sector where a collision is not possible (for an awning, for example, this might be an extension of 0 to 30%). In order to report the safe position of the drive mechanism, either a zero position sensor (e.g. final position switch or light barrier) may be connected at an input of the actuator, or the actuator receives the message of its zero position sensor by the bus (see graphic in chapter *Connection options for zero position sensors* in the general part).

Before the drive mechanism of the master actuator is moved, the slave actuator receives the command to move its drive mechanism to the safe position. As a consequence, the slave remains in safe position or it moves back if it is not within the safe range.

The master actuator knows from the communication object „Slave zero position status“ whether the drive mechanism connected to the slave actuator is already in a safe position (then the master moves immediately) or not (then the master waits). Only if the master actuator is informed that the slave drive mechanism is in a safe position, it moves its drive mechanism beyond its own safe position.

Example:

The ventilation with the window shall take priority over the shading with the awning. Therefore, the window is parameterised as master, the awning as slave. Both are provided with a zero position sensor which reports whether the drive mechanism is in a safe position or not.

The awning is now extended and the window shall be opened. The window knows the status of the awning (“not safe position”) and therefore submits a master command to the awning. This is the signal for the awning, to retract a little bit. As soon as the awning has reached a safe position, there is an according feedback signal of the zero position sensor of the awning. Only now the window opens.



Master and slave regularly exchange their positions (“safe” or “not safe”). By means of the monitoring period, you may adjust the frequency of information retrieval. The selected period should be shorter than the period which the monitored drive mechanism needs to travel from the limit of the safe range (last reported safe position) to a position where there is risk of collision.

If the drive mechanism does not receive a master/slave or zero position object, it moves to the safe position. The same holds true for a bus voltage breakdown or for a malfunction message from the zero position sensor (is valid for the parameterisation as master and as slave).

Without movement range limitation:

Use movement range limit	no
Behaviour following a failure of the bus power supply	<ul style="list-style-type: none"> • <u>no action</u> • Stop • Up command (or On/Down) • Down command (or Off/Up)
Behaviour on bus voltage restoration and after programming	<ul style="list-style-type: none"> • <u>no action</u> • Up command (or On/Down) • Down command (or Off/Up)

With movement range limit:

Set if the zero position sensor of the drive is directly connected to the actuator (input channel) or if the zero position is received via the bus (communication object).

Use movement range limit	yes
Zero position sensor connected as	<ul style="list-style-type: none"> • <u>communication object</u> • <u>input channel</u>
Actuator is	<u>master</u> • slave

Actuator as master:

Actuator is	master
Send repetition for master command in sec	1 ... 255; <u>10</u>
Monitoring period for slave status (and zero position) object in sec	1 ... 255; <u>10</u>

Actuator as slave:

Actuator is	slave
Send repetition for slave commands in sec	1 ... 255; <u>10</u>
Monitoring period for master status (and zero position) object in sec	1 ... 255; <u>10</u>
Movement position for slave in % if input "Master zero position command" = 1	<u>0</u> ... 100

Reference travel direction:

If the travel range is limited, the direction of the reference travel is fixed (safe position). The direction can be set without limiting the travel range.

Direction of reference travel	<ul style="list-style-type: none"> • <u>in safe position</u> • in closed position (<i>move out shading</i>) • in open position (<i>window</i>) • shortest route
-------------------------------	---

Blocking objects:

The output channel can be blocked in case of rain, wind or other events. The manual operation is then not possible. Blocking and monitoring are configured here first. For setting the individual blocks, separate menu items "Blocking X" will appear (see chapter *Block – blocking objects*, page 29, *Block – wind blocking*, page 30 and *Block – rain blocking*, page 31).

The priorities of the blocking objects correspond to the sequence listed (Block 1 has the highest priority, Block 5 the lowest).

Use Block 1 (high priority)	<ul style="list-style-type: none"> • <u>no</u> • yes, with blocking object • yes, as wind blocking • yes, as rain blocking
-----------------------------	--

Use block 2	<ul style="list-style-type: none"> • <u>no</u> • yes, with blocking object • yes, as wind blocking • yes, as rain blocking
Use block 3	<ul style="list-style-type: none"> • <u>no</u> • yes, with blocking object • yes, as wind blocking • yes, as rain blocking
Use block 4	<ul style="list-style-type: none"> • <u>no</u> • yes, with blocking object • yes, as wind blocking • yes, as rain blocking
Use Block 5 (low priority)	<ul style="list-style-type: none"> • <u>no</u> • yes, with blocking object • yes, as wind blocking • yes, as rain blocking
Priority is	<ul style="list-style-type: none"> • <u>Block 5 over Manual</u> • Manual over Block 5
Use monitoring of blocking objects	<u>No</u> • Yes
Monitoring period for blocking objects (only if using monitoring of the blocking objects)	5s... • 2 h; <u>5 min</u>
Behaviour if a blocking object is not received (only if blocking object monitoring is used)	<ul style="list-style-type: none"> • <u>Stop</u> • Up command • Down command (Shutters/roller blinds) • On command • Off command (Awnings) • Close command • Open command (Windows)

Use movement limit 1/2:

The movement limits are activated here, and can them be configured in their own menu items. See 'Movement limits' on Page 30.

Short time restriction (for blinds):

If short time restriction is active, only short time movement commands are still possible manually. If the function "Allow step commands only for blind adjustment" is activated simultaneously, (see *Channel settings – drives*, page 23) only the slats can still be adjusted by hand but no longer the movement position of the shutter.

Restriction is active for object value 1.

Use short time limit	<u>no</u> • yes
Value of the object in front of 1. communication and bus voltage restoration (if short time restriction is used)	<u>0</u> • 1

Automatic reset:

With the manual operation the automatic of the drive is deactivated. Here it is set when the automatic is reactivated.

Manual switches to automatic after	<ul style="list-style-type: none"> • <u>expiry of a waiting period</u> • reception of an object • expiration of a waiting period or receipt of an object
Waiting period in min (if "Expiration of a waiting period" was chosen)	1...255; <u>20</u>
Switch to automatic for an object value (if "Receipt of an object" was chosen)	0 • <u>1</u> • 0 or 1

Automatic blocking object:

With the automatic blocking object, the automatic can be deactivated for a short term (e.g. if present or during speeches in conference rooms). Here it is also specified in which mode the channel is found when the voltage returns, i.e. after a power failure. The mode (manual or automatic) is send as a status object to the bus.

Use automatic blocking object	<u>no</u> • yes
Operating mode after power returns	<ul style="list-style-type: none"> • <u>Automatic</u> • Manual
Send status object	<ul style="list-style-type: none"> • <u>1 for automatic</u> <u>0 for manual</u> • 0 for automatic 1 for manual
Send delay of the status output Automatic or Manual in 0.1 sec	<u>0</u> ...50

Type of automatic:

The automatic for the connected drive can be specified externally, however all the settings can also be configured internally. If "internal automatic" is chosen, a separate menu item "Automatic" (see chapter *Movement limits*, page 32 or *Automatic for windows (drives)*, page 38) appears.

Type of automatic	<u>external automatic</u> • internal automatic
-------------------	--

Block – blocking objects

The menu item only appears if a block with blocking object was configured for "control". Here it is specified was happens for object value 1 and 0. Via the free blocking object, a fire alarm scenario may be configured for example (create escape routes by retracting the shading, smoke extraction via windows). This can prevent being locked out on the patio (opened window contact of the patio door blocks the shutter in front of the door).

Designation	[Block 1 ... 5] Enter a designation here!
If blocking object has value =1	<ul style="list-style-type: none"> • no action • stop • move into position • <u>up-command</u> • down-command (<i>shutter/blind</i>) • <u>retract-command</u> • extend-command (<i>awning</i>) • <u>close-command</u> • open-command (<i>window</i>)
<i>Position in % (only if by using a block, a specific position is achieved)</i>	<u>0</u> ...100
<i>Slat position in % (only if by using a block, a specific shutter position is achieved)</i>	<u>0</u> ...100
If blocking object has value =0	
For manual operation before and after blocking	<ul style="list-style-type: none"> • <u>no action</u> • move into last position
For automatic operation after blocking	follow automatic
Value of the object before the 1st communication and bus voltage return	0... <u>1</u>

Block – wind blocking

The menu item only appears if a wind blocking was configured for "control". The input object "wind blocking" is linked with the output object of a wind sensor. The input can be a 1bit object (smaller or larger than a threshold value), as well as a 16bit object (measurement value).

Designation	[Wind blocking] Enter a designation here!
Type of input object	<u>1 bit</u> • 16 bit

1 bit input object:

Type of input object	1 bit
If blocking object has value =1	<ul style="list-style-type: none"> • no action • stop • move into position • <u>up-command</u> • down-command (<i>shutter/blind</i>) • <u>retract-command</u> • extend-command (<i>awning</i>) • <u>close-command</u> • open-command (<i>window</i>)
<i>Position in % (only if by using a block, a specific position is achieved)</i>	<u>0</u> ...100

<i>Slat position in % (only if by using a block, a specific shutter position is achieved)</i>	<u>0</u> ...100
Waiting period in secure position in min after blocking	1...255; <u>5</u>
Behaviour after waiting period	
For manual operation before and after blocking	<ul style="list-style-type: none"> • <u>no action</u> • move into last position
For automatic operation after blocking	follow automatic

16 bit input object:

Type of input object	16 bit
As of wind speed in m/s blocking	2...30; <u>5</u>
If blocking is active	<ul style="list-style-type: none"> • no action • stop • move into position • <u>up-command</u> • down-command (<i>shutter/blind</i>) • <u>retract-command</u> • extend-command (<i>awning</i>) • <u>close-command</u> • open-command (<i>window</i>)
Waiting period in secure position in min after blocking	1...255; <u>5</u>
Behaviour after waiting period	
For manual operation before and after blocking	<ul style="list-style-type: none"> • <u>no action</u> • move into last position
For automatic operation after blocking	follow automatic
Send current blocking status	<u>no</u> • yes

Block – rain blocking

The menu item only appears if a rain blocking was configured for "control". The input object "rain blocking" is linked with the output object of a rain sensor.

Designation	[rain blocking] Enter a designation here!
If blocking object has value =1	<ul style="list-style-type: none"> • no action • stop • move into position • <u>up-command</u> • down-command (<i>shutter/blind</i>) • <u>retract-command</u> • extend-command (<i>awning</i>) • <u>close-command</u> • open-command (<i>window</i>)

Position in % (only if by using a block, a specific position is achieved)	<u>0</u> ...100
Slat position in % (only if by using a block, a specific shutter position is achieved)	<u>0</u> ...100
Waiting period in secure position in min after blocking	1...255; <u>5</u>
Behaviour after waiting period	
For manual operation before and after blocking	<ul style="list-style-type: none"> • <u>no action</u> • move into last position
For automatic operation after blocking	follow automatic

Movement limits

The menu item appears only if a movement limit was activated in 'Control'. Movement limits can be used to restrict manual movement. The limit is active for object value 1

Limitation type	<ul style="list-style-type: none"> • <u>full</u> • movement position • slat angle (for shutters) • allow UP only • allow DOWN only
Value of the object in front of 1. Communication and bus voltage restoration	<u>0</u> • 1

If limiting the movement position:

Limitation type	• movement position
Movement allowed in the position range	
from (in %)	<u>0</u> ...100
to (in %)	<u>0</u> ... <u>100</u>

If limiting the slat angle (shutters only):

Limitation type	• slat angle
Movement allowed in the angle range	
from (in %)	<u>0</u> ...100
to (in %)	<u>0</u> ... <u>100</u>

5.2.1.2. Manual

Position memory for the manual movement can be activated here. The position set here can be overwritten via a learning object at any time. The memorised position can be retrieved again at a later time.

For shutters, both the movement and the slat position can be stored.

Use position memory	<u>no</u> • yes
---------------------	-----------------

Use different positions for object values 0 and 1	<u>no</u> • yes (if 'yes' is selected, there will be a division into positions for object value 0 and object value 1)
Position in %	<u>0</u> ...100
Allow calling via command sequence: long-term = 1, short-term = 1	<u>no</u> • yes
Use learning object for new position	<u>no</u> • yes
<i>Transfer when programming (when learning object is used)</i>	<ul style="list-style-type: none"> • <u>all parameters</u> • changed parameters only

5.2.1.3.Automation - external

The 'External automation' menu item appears if the external automation is selected in 'Control'. In this case, the position memory can be activated for the automatic movement. The position set here can be overwritten via a learning object at any time. The memorised position can be retrieved again at a later time. For configuration options, see Chapter 'Manual' on Page 31.

5.2.1.4.Automatic - internal for shading (drives)

The menu item "Automatic internal" appears if internal automatic is selected for "control". The internal automatic functions take into account the brightness/position of the sun, outdoor and indoor temperature and allow a time and dimming control. A shading position can be specified or taught.

To be able to fully utilize the internal shading automatic, information about brightness/twilight, outdoor and indoor temperature, time and position of the sun must be present in the bus system.

Outdoor temperature block:

The input object "outdoor temperature block" is linked with the output object of a temperature sensor. The input object can be a 1bit object (smaller or larger than a threshold value), as well as a 16bit object (measurement value).

Use automatic blocking object	<u>no</u> • yes
-------------------------------	-----------------

Use automatic blocking object	yes
Type of temperature input object	<u>1 bit</u> • 16 bit

1 bit input object:

Type of temperature input object	1 bit
----------------------------------	--------------

Shading is allowed if the bit is 0 and blocked if the bit is 1.

16 bit input object:

Type of temperature input object	16 bit
Threshold value in 0.1°C	-300 ... 800; <u>50</u>

Hysteresis in 0.1°C	1 ... 100; <u>20</u>
Send current blocking status	<u>no</u> • yes

Shading is allowed

if the measurement value is larger than the threshold value+hysteresis and blocked

if the measurement value is smaller than or equal to the threshold value.

Twilight/time control:

The time control is provided via a communication object. The input object "twilight control" is linked with the output object of a brightness sensor. A 1bit object (smaller or larger than a threshold value), as well as a 16bit object (measurement value) can be used for the twilight control.

Use twilight/time control	<ul style="list-style-type: none"> • <u>no</u> • only twilight control • only time control • both (OR linking)
---------------------------	--

Use twilight/time control	only twilight control / both
Type of twilight object	<u>1 bit</u> • 16 bit

16 bit input object:

Type of twilight object	16 bit
Twilight threshold value in lux	1 ... 1000; <u>10</u>
Switching delay	1 minute
Send current twilight status	<u>no</u> • yes

Indoor temperature release:

The input object "indoor temperature release" is linked with the output object of a temperature sensor. The input object can be a 1bit object (smaller or larger than a threshold value), as well as a 16bit object (measurement value or target and actual value).

Use inside temperature release	<u>no</u> • yes
--------------------------------	-----------------

Type of input object	<u>1 bit</u> • 16 bit • 16 bit target/actual temperature
----------------------	--

16 bit input object:

Type of input object	16 bit
Threshold value in 0.1°C	-300 ... 800; <u>200</u>
Hysteresis in 0.1°C	1 ... 100; <u>20</u>
Send current blocking status	<u>no</u> • yes

16 bit input object (target/actual temperature):

For this function the target value and actual value (measurement values) are imported from the 16bit object and evaluated.

Type of input object	16 bit target/actual temperature
Target value (SW) – actual value (MW) Difference in 0.1°C	1 ... 100; <u>20</u>
Hysteresis in 0.1°C	1 ... 100; <u>20</u>
Send current blocking status	<u>no</u> • yes

Shading is allowed if the measurement value is greater than or equal to the target value+difference

and blocked if the measurement value is smaller than the target value+hysteresis difference.

Automatic shading:

The automatic shading evaluates the input objects "brightness" and "position of the sun" of a weather station. The moving position for the automatic shading is specified here as well.

Use automatic shading	<u>no</u> • yes
-----------------------	-----------------

Brightness:

For controlling brightness, a 1bit object (smaller or larger than a threshold value), as well as two or three 16bit objects (measurement values, e.g. East, South and West sun) can be used.

Type of shading input	<u>1 x 1 bit</u> • 1 x 16 bit • 2 x 16 bit • 3 x 16 bit
-----------------------	---

1 x 1 bit input object:

Set the delay times for shading (prevents constant opening and closing when light conditions change quickly).

Type of shading input	1 x 1 bit
Drive up delay in min	0 ... 255; <u>12</u>
Departure delay in min	0 ... 30; <u>1</u>

1 x 16 bit, 2 x 16 bit or 3 x 16 bit as an input object:

The brightness threshold value can be specified per parameter or communication object. For several brightness measurement values (2 x 16 bit or 3 x 16 bit) only the maximum brightness value is compared to the threshold value.

Type of shading input	1 x 16 bit • 2 x 16 bit • 3 x 16 bit
Shading threshold specification per	<u>parameter</u> • communication object

Threshold value per parameter:

Set the threshold value and delay times for shading (prevents constant opening and closing when light conditions change quickly).

Shading threshold specification per	Parameter
Shading threshold value in klux	0 ... 100; <u>30</u>
Drive up delay in min	0 ... 255; <u>12</u>
Drive down delay in min	0 ... 30; <u>1</u>
Send current shading status	<u>No</u> • Yes

Threshold value per communication object:

The threshold value is received via the communication object and can be changed additionally (e.g. button for "more sensitive" and "less sensitive"). Set the delay times for shading here (prevents constant opening and closing when light conditions change quickly).

Shading threshold specification per	communication object
The value communicated last shall be retained	<ul style="list-style-type: none"> • <u>not</u> • after voltage returns • after voltage returns and programming
Start threshold value in klux valid until 1st communication	0 ... 100; <u>30</u>
Type of limit value change	<ul style="list-style-type: none"> • <u>Absolute value with a 16bit comm. object</u> • Lifting/lowering with a comm. object • Lifting/lowering with two comm. objects
Increments in klux (only when "lifting/lowering with comm. object")	1 ... 5; <u>2</u>
Drive up delay in min	0 ... 255; <u>12</u>
Drive down delay in min	0 ... 30; <u>1</u>
Send current shading status	<u>no</u> • yes

Position of the sun:

Assess position of the sun	<u>no</u> • yes
Assess position of the sun	yes
Position of the sun is defined via	<ul style="list-style-type: none"> • <u>Discreet value of azimuth and elevation</u> • Directions (regarding azimuth and elevation)

Defining position of sun via values:

Enter the range (direction and height) in which the sun must be located for the shading to be active.

Position of the sun is defined via	discreet value of azimuth and elevation
Azimuth from	<u>0</u> ... 360

Azimuth to	<u>0</u> ... 360
Elevation from	<u>0</u> ... 90
Elevation to	<u>0</u> ... 90

Defining position of the sun via directions:

Enter the direction in which the sun must be positioned so that the shading is active.

Position of the sun is defined via	directions (regarding azimuth and elevation)
Directions	<ul style="list-style-type: none"> • East (azimuth: 0° ... 180°) • South east (azimuth: 45° ... 225°) • South (azimuth: 90° ... 270°) • South west (azimuth: 135° ... 315°) • West (azimuth: 180° ... 360°)

Slats and moving position (for shutters):

For shutters the angle of the slats can be firmly set, or the slats can automatically follow the elevation. This rule applies: Slats are closed at 100%, horizontal at 50%.

Should the slats follow the elevation	<u>no</u> • yes
---------------------------------------	-----------------

The slats should **not** follow the elevation (fixed reversing angle):

Adjust the desired position of the slats and the curtain.

Should the slats follow the elevation	no
Slat position in %	0 ... 100; <u>75</u>
Shutter position in %	0 ... 100; <u>75</u>
Use teaching object for new shading position (curtain and slat positions will be saved, see info below)	<u>no</u> • yes

The slats shall follow the elevation:

Three different elevation ranges can be set. A fixed curtain and slat position is specified for each.

Should the slats follow the elevation	yes
For an elevation less than (in degrees)	0 ... 90; <u>10</u>
Slat position in %	0 ... 100; <u>95</u>
otherwise	0 ... 100
Slat position in %	0 ... 100
Shutter position in %	0 ... 100
Use teaching object for new shading position (only the curtain position will be saved, see info below)	<u>no</u> • yes

Moving position (for awnings and blinds):

Awning position in % or blind position in %	0 ... 100; <u>75</u>
Use teaching object for new shading position	<u>no</u> • yes

Use teaching object for new shading position: The curtain position it can be specified numerically or taught manually. For teaching set "use teaching object: Yes" and the "channel X shading position teaching object" is used for saving the position reached. Saving occurs for value = 1 and can for example be realized via a button linked to the teaching object. Numerical specifications already set are overwritten by the teaching object.

5.2.1.5. Automatic for windows (drives)

The menu item "Automatic" only appears if internal automatic is selected for "Control". Depending on the setting, the internal automatic functions take the outdoor temperature, indoor temperature and room air humidity into account, and allow forced ventilation via a communication object.

In order to fully utilize the internal ventilation automatic, information about the outdoor and indoor temperature and the inside air humidity must be present in the bus system.

Cold supply air lock:

The input object "cold supply air block" is linked with the output object of a temperature sensor. The input object can be a 1bit object (smaller or larger than a threshold value), as well as a 16bit object (measurement value).

Use cold supply air block	<u>no</u> • yes
Use cold supply air block	yes
Type of temperature input object	<u>1 bit</u> • 16 bit

1bit input object:

Type of temperature input object	1 bit
----------------------------------	--------------

Ventilation is allowed if the bit is 0 and blocked if the bit is 1.

16bit input object:

Type of temperature input object	16 bit
Threshold value in 0.1°C	-300 ... 800; <u>50</u>
Hysteresis in 0.1°C	1 ... 100; <u>20</u>
Send current blocking status	<u>no</u> • yes

Ventilation is allowed if the measurement value is larger than the threshold value+hysteresis and blocked if the measurement value is smaller than or equal to the threshold value.

Forced ventilation:

Use forced ventilation	<u>no</u> • yes
------------------------	-----------------

If forced ventilation is active ("use forced ventilation: Yes"), ventilation is started as soon as the communication object "forced ventilation" = 1.

Warm supply air block:

The input object "warm supply air block" is linked with the output object of one or more temperature sensors. The input object can be a 1bit object (smaller or larger than a threshold value), as well as a 16bit object (measurement value indoor/outdoor or target and actual value).

Use warm supply air block	<u>no</u> • yes
---------------------------	-----------------

Use warm supply air block	yes
Type of input object	<u>1 bit</u> • 16 bit • 16 bit target/actual temperature

1bit input object:

Type of input object	1 bit
----------------------	--------------

Ventilation is allowed if the bit is 0 and blocked if the bit is 1.

16bit input object:

Type of input object	16 bit
Threshold value in 0.1°C	-100 ... 200; <u>50</u>
Hysteresis in 0.1°C	1 ... 100; <u>20</u>
Send current blocking status	<u>no</u> • yes

Ventilation is allowed if the outdoor measurement value is smaller than the indoor measurement value+difference-hysteresis and blocked if the outdoor measurement value is greater than or equal to the indoor measurement value+difference.

16bit input object (target/actual temperature):

For this function the target value and actual value (measurement values) are imported from the 16bit object and evaluated.

Type of input object	16 bit target/actual temperature
Close if outdoor temperature exceeds the target value by (in 0.1°C)	0...255; <u>50</u>
Hysteresis in 0.1°C	1...100; <u>20</u>
Send current blocking status	<u>no</u> • yes

Ventilation is allowed if the outdoor measurement value is smaller than the target value+difference-hysteresis and blocked if the outdoor measurement value is greater than or equal to the target value+difference.

Open by temperature/humidity:

Open window	<ul style="list-style-type: none"> • <u>never</u> • if too high temperature • if too high room air humidity • if too high temperature or room air humidity
-------------	--

Indoor temperature:

These parameters appear if ventilated at "too high temperature" / "too high temperature or room air humidity". The input object can be a 1bit object (smaller or larger than a threshold value), as well as a 16bit object (measurement value or target and actual value).

Type of temperature input object	<u>1 bit</u> • 16 bit • 16 bit target/actual temperature
----------------------------------	--

1 bit input object:

Type of temperature input object	1 bit
----------------------------------	--------------

Ventilation is activated if the bit is 0 and blocked if the bit is 1.

16 bit input object:

The threshold value specification can be provided via a parameter or communication object.

Type of temperature input object	16 bit
Indoor temperature of threshold specification via	<u>parameter</u> • communication object

Threshold value per parameter:

Indoor temperature of threshold specification via	parameter
Indoor temperature threshold value in 0.1?	-100 ... 500; <u>300</u>
Hysteresis in 0.1?	1 ... 100; <u>20</u>
Send current temperature status	<u>no</u> • yes

Threshold value per communication object:

The threshold value is received via the communication object and can be changed additionally (e.g. button for target temperature + and -).

Indoor temperature threshold specification via	communication object
The value communicated last shall be retained	<ul style="list-style-type: none"> • <u>not</u> • after voltage returns • after voltage returns and programming
Start threshold value in 0.1°C valid until 1st communication	100 ... 500; <u>300</u>

Type of limit value change	<ul style="list-style-type: none"> • <u>Absolute value with a 16bit comm. object</u> • Lifting/lowering with a comm. object • Lifting/lowering with two comm. objects
Increments (only when "lifting/lowering with comm. object")	0.1°C ... 5°C; <u>1°C</u>
Hysteresis in 0.1?	1 ... 100; <u>20</u>
Send current temperature status	<u>no</u> • yes

16 bit input object (target/actual temperature):

For this function the target value and actual value (measurement values) are imported from the 16bit object and evaluated.

Type of temperature input object	16 bit target / actual temperature
Open if actual value exceeds the target value (in 0.1°C)	0...255; <u>20</u>
Hysteresis in 0.1°C	1...100; <u>20</u>
Send current blocking status	<u>no</u> • yes

Room air humidity:

These parameter appear if ventilated at "too high room air humidity" / "too high temperature or room air humidity". The input object can be a 1bit object (smaller or larger than a threshold value), as well as a 16bit object (measurement value).

Type of humidity input object	<u>1 bit</u> • 16 bit
-------------------------------	-----------------------

1 bit input object:

Type of humidity input object	1 bit
-------------------------------	--------------

Ventilation is activated if the bit is 0 and blocked if the bit is 1.

16 bit input object:

Type of humidity input object	16 bit
Indoor humidity threshold value in %	0 ... 100; <u>60</u>
Hysteresis in 0.1°C	1 ... 100; <u>5</u>
Send current humidity status	<u>no</u> • yes

Window opening:

If the ventilation by temperature or humidity is controlled via a 1bit input object, then enter the opening position in %.

Window opening in %	1... <u>100</u>
---------------------	-----------------

If the ventilation is controlled by temperature and humidity via a 16bit input object, then you can either set an opening position or open the windows incrementally. In the

step operation the temperature/humidity deviation is checked after a specified period of time, and may be increased/decreased by one step.

Window opening	<u>absolute in %</u> • incrementally
Window opening in % (only if "window opening is absolute in %")	1... <u>100</u>
incrementally by (in %) (only if "window opening is in increments")	1...100; <u>25</u>
every (in minutes) (only if "window opening is in increments")	1...60; <u>3</u>

5.2.1.6.Scenes (drives)

A group address for scenes must be filed in the KNX system to control the scenes. The input object 'Channel X: call/save scenes' of the actuator is linked to this group address.

A scene is **called**, then the **scene number** is communicated to the actuator. The movement position saved for this scene number in the actuator is then taken. If the scene **saving** function is used, then the current movement position is saved for this scene number in the actuator.

The 'Scenes' menu item of the actuator is only shown if 'Use scenes: yes' was selected in the settings for the drive channel. Every drive can **have up to 16 scene save points** for movement positions.

Activate a scene save point.

Use scene save point X	<u>no</u> • yes
------------------------	------------------------

Assign a scene number to the scene save point. Use this scene number to call/save the movement position stored in the actuator. Make sure that every scene number is used only once per drive channel.

Scene number	<u>0</u> ...127
--------------	-----------------

Set the movement position. If it is allowed to save scenes via the bus, this position only applies after the ETS download until the first manual saving. Afterwards, the new movement position saved in the actuator is used.

Shutter position in % or Blind position in % or Awning position in % or Window position in %	0...100; <u>50</u>
Slat position in % (only for shutters)	0...100; <u>70</u>

5.2.1.7.Button inputs (drives)

Depending on the model, there are no inputs, two or four inputs.

The inputs can be used as actuator button or bus button. If a temperature sensor (eg. T-NTC) is connected, the input is configured as a push button with function „temperature sensor (NTC)“.

For connected drives the input 1 can be used *alternatively* for a zero position sensor.

Operating mode	
Use input 1	<ul style="list-style-type: none"> • no • as a bus button • <u>as an actuator switch</u> • as a zero position sensor
Use input 2 (3 / 4)	<ul style="list-style-type: none"> • no • as a bus button • <u>as an actuator switch</u>

Input as bus button

If an input is used as a free bus button, it will send a previously set value to the bus when activated. In the program file of the actuator different parameters are integrated for frequently needed bus functions. Thus, the inputs can easily be configured as a switch, drive control, dimmer for sending values and for the scene calls.

Bus function	<ul style="list-style-type: none"> • <u>Switch</u> • <u>Selector switch</u> • <u>Shutter</u> • <u>Blind</u> • <u>Awning</u> • <u>Window</u> • <u>Dimmer</u> • <u>8 bit encoder</u> • <u>Temperature encoder</u> • <u>Brightness encoder</u> • <u>Scenes</u>
--------------	--

Input as switch:

If a button with switch function is assigned to the input, select the bus function "Switch" and specify which value is sent when pressing/releasing the button and when it will be sent.

Function	Switch
Command when pressing the button	<ul style="list-style-type: none"> • send 0 • <u>send 1</u> • do not send telegram
Command when releasing the button	<ul style="list-style-type: none"> • <u>send 0</u> • send 1 • do not send telegram

Send value	<ul style="list-style-type: none"> • <u>no change</u> • for change to 1 • for change to 0 • for change and cyclical • for change to 1 and cyclical • for change to 0 and cyclical
Cycle (if sent cyclical)	5 s • 10 s • 30 s • 1 min • 2 min • 5 min • 10 min • 20 min • 30 min • 1 h • 2 h

The input can be blocked using a blocking object. Set what is transmitted to the bus when (de)activating blocking.

For active blocking there is *no* cyclical transmission.

Use blocking object	<u>No</u> • Yes
Once when activating the blocking	<ul style="list-style-type: none"> • send 0 • <u>send 1</u> • do not send telegram
Once when deactivating the blocking	<ul style="list-style-type: none"> • <u>send 0</u> • send 1 • do not send telegram • send current state

Input as changeover switch:

If a button with switch function is assigned to the input, select the bus function "Changeover Switch" and specify if the button should switch when pressed/released.

Function	Changeover Switch
Command when pressing the button	<ul style="list-style-type: none"> • <u>Switching</u> • do not send telegram
Command when releasing the button	<ul style="list-style-type: none"> • Switching • <u>do not send telegram</u>

The input can be blocked using a blocking object. For active blocking there is *no bus communication*.

Use blocking object	<u>No</u> • Yes
---------------------	-----------------

Input to shutter, blinds, awning or window control:

If the input to the drive control is used via the bus, select the bus function "shutter", "awning", "blinds" or "window" and specify the button function and control mode.

Function	Shutter / blinds / awning / window
----------	---

Button function	<u>Up</u> • Down <u>Up</u> • Down • Up/ Down <u>On</u> • Off • On/Off <u>Open</u> • Closed • Open/Closed	(shutter) (blinds) (awning) (window)
Control mode*	<ul style="list-style-type: none"> • Standard • Standard inverted • Comfort mode • Dead man's switch 	

*A detailed description of the setting options for the individual control modi can be found in the general part of chapter *Control modi for drive control*, page 47.

The input can be blocked using a blocking object. For active blocking there is *no bus communication*.

Use blocking object	<u>No</u> • Yes
---------------------	-----------------

Input as dimmer:

If the input is used as a dimmer, select the bus function "Dimmer" and specify the button function, time interval (switching/dimming) and if requested, the repeat interval for a long button press.

Function	Dimmer
Button function	<u>brighter</u> • darker • brighter/darker
Time between switching and dimming (in 0.1 s)	1...50; <u>5</u>
Repeat the dimm command	<u>no</u> • yes
Repeat the dimm command for a long button press (if dimm command is repeated)	every 0.1 s • every 2 sec; <u>every 0,5 sec</u>
Dim by (if dimm command is repeated)	1,50% • 3% • <u>6 %</u> • 12,50% • 25% • 50%

The input can be blocked using a blocking object. For active blocking there is *no bus communication*.

Use blocking object	<u>No</u> • Yes
---------------------	-----------------

Input 8 bit encoder:

If the input is to be used as an 8bit encoder, select the "8 bit encoder" bus function and specify which value will be sent.

Function	8 bit encoder
Value	<u>0</u> ...255

The input can be blocked using a blocking object. For active blocking there is *no bus communication*.

Use blocking object	<u>No</u> • Yes
---------------------	-----------------

Input as temperature encoder:

If the input is used as a temperature encoder, then choose the bus function "Temperature encoder" and specify which value between -30°C and +80°C will be sent. By sending a temperature value, the target value of the temperature control may be changed for example.

Function	Temperature encoder
Temperature in 0.1°C	-300...800; <u>200</u>

The input can be blocked using a blocking object. For active blocking there is *no bus communication*.

Use blocking object	<u>No</u> • Yes
---------------------	-----------------

Input as brightness encoder:

If the input is assigned and shall be used as a brightness encoder (e.g. threshold value of a sun sensor), select "brightness encoder" and specify which value will be sent.

Function	Brightness encoder
Brightness in klux	0...100; <u>20</u>

The input can be blocked using a blocking object. For active blocking there is *no bus communication*.

Use blocking object	<u>No</u> • Yes
---------------------	-----------------

Input for scene control:

If scenes are called and saved with the input, then choose the "Scenes" bus function and specify the saving, time difference (call/save) and scene number.

Function	Scenes
Button operation	<ul style="list-style-type: none"> • <u>without saving</u> • with saving
Time between calling and saving in 0.1 seconds (only if selected "with saving")	1...50; <u>10</u>
Scene No.	<u>0</u> ...127

The input can be blocked using a blocking object. For active blocking there is *no bus communication*.

Use blocking object	<u>No</u> • Yes
---------------------	-----------------

Input with temperature sensor (NTC):

If a temperature sensor is connected to the input, then choose the bus function „temperature sensor“ and set specifications for malfunction object, offset, mixed value and sending behavior.

The offset compensates measurement errors, for example caused by interference sources.

Bus function	Temperature sensor (NTC)
Use malfunction object	<u>No</u> • Yes
Offset in 0.1°C	-50...50; <u>0</u>
Use external measured value	<u>No</u> • Yes
Ext. MV ratio of the total value (only if an ext. MV is used)	5% • 10% • ... • <u>50%</u> • ... 95% • 100%
Transmit behaviour	<ul style="list-style-type: none"> • cyclically • <u>on change</u> • on change and cyclically
Send value all (only when sending cyclically)	<u>5 s</u> ... 2 h
On change of (only when sending on change)	0.1°C ... 5°C; <u>5.0°C</u>

If a mixed value from own and external measuring value has been set, then all the following settings pertain to the total measured value.

Input as actuator button

If this channel is used for the input to the control of the drive, then specify the button function and the control mode.

Button function	<u>Up</u> • Down <u>Up</u> • Down • <u>Up/Down</u> <u>On</u> • Off • On/Off <u>Open</u> • Closed • Open/Closed	(shutter) (blind) (awning) (window)
Control mode*	<ul style="list-style-type: none"> • <u>Standard</u> • Standard inverted • Comfort mode • Dead man's switch 	

*A detailed description of the setting options for the individual control modi can be found in the chapter *Control modi for drive control*, page 47.

The input can be blocked using a blocking object. No operation is possible for an active block.

Use blocking object	<u>No</u> • Yes
---------------------	-----------------

If monitoring periods or movement range limits are used, no operation via the local button is possible in case of a bus voltage failure.

Input as zero position sensor

The zero position sensor is used for the movement range limit of the respective drive (see *Channel settings – drives*, page 23). In case of a defect zero position sensor a malfunctioning message can be sent to the bus.

Send malfunction message when zero position sensor is defective	<u>No</u> • Yes
---	-----------------

5.2.2. Output channel with drive

Control modi for drive control

If inputs are used as buttons for operating shading or windows, then different control modi can be set.

Control mode	<ul style="list-style-type: none"> • Standard • Standard inverted • Comfort mode • Dead man's switch
--------------	--

Standard:

If briefly operated, the drive will move incrementally or stops. If operated longer, the drive will move up to the end position. The time difference between "short" and "long" is set individually.

Control mode	Standard
Behavior during button operation: short = stop/increment long = Up or Down	
Time between short and long in 0.1 seconds	1...50; <u>10</u>

Standard inverted:

When pushed shortly, the drive moves up to the end position. When pushed for longer, the drive moves incrementally or stops. The time difference between "short" and "long" and the repeat interval is set individually.

Control mode	Standard inverted
Behavior during button operation: short = Up or Down long = Stop/Step	
Time between short and long in 0.1 seconds	1...50; <u>10</u>
Repeat the step command for a long button press	every 0.1 s • every 2 sec; <u>every 0.5 sec</u>

Comfort mode:

In the **comfort mode** pushing the button briefly, a bit longer and long will trigger different responses of the drive. The time intervals are set individually.

By pushing the button (shorter than adjustable time 1) the drive will be positioned (resp. stopped) incrementally.

If the drive is to be moved a bit farther, then a little longer push is needed (longer than time 1 but shorter than time 1+2). The drive stops immediately when releasing the button.

If the drive must be moved independently into the end position, the button is released only after times 1 + 2 have expired. The move can be stopped by briefly pushing.

Fig. 8

Time interval comfort mode diagram

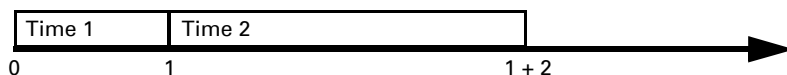

<i>Point in time 0:</i>	<i>Push of button, start of time 1 step (or stop if drive is moving)</i>
<i>Release before time 1 expired:</i>	<i>step (or stop if drive is moving)</i>
<i>Point in time 1:</i>	<i>End of time 1, start of time 2</i>
	<i>Moving command</i>
<i>Release after time 1 expired but before time 2 expires:</i>	<i>Stop</i>
<i>Release after time 1 + 2 expired:</i>	<i>Move into end position</i>

Control mode	Comfort mode
Behavior during button operation: Button is pushed and released before time 1 expired = stop/step held longer than time 1 = Up or Down released between time 1 and 1-2= stop released after time 1 +2 = no more stop	
Time 1	0.0s ... • 2 s; <u>0,4 s</u>
Time 2	0 s • 2 s; <u>2 s</u>

Dead man's switch:

The drive moves as soon as the button is pushed and stops as soon as the button is released.

Control mode	Dead man's switch
Behavior during button operation: Push button = Up or Down command Release button = Stop command	

5.2.3. Connection option for zero position sensors

See also section *Movement Range Limit* in chapter *Control (drives)*, page 25. The examples and the communication object numbers refer to the mutual master-slave coupling of drives at the output channel A and channel B.

**Actuator A is Master, zero position sensor at input 1 of the actuator,
Actuator B is Slave, zero position sensor at input 1 of the actuator:**

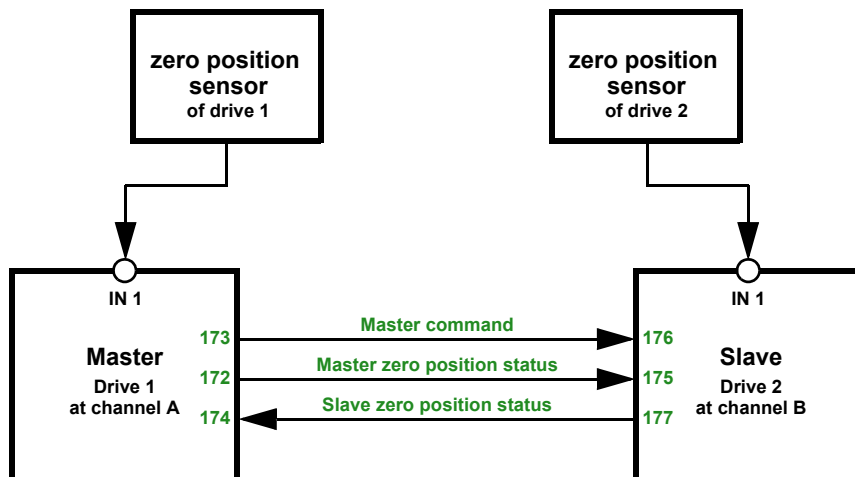

**Actuator A is Master, zero position sensor at input 1 of the actuator,
Actuator B is Slave, zero position sensor via bus:**

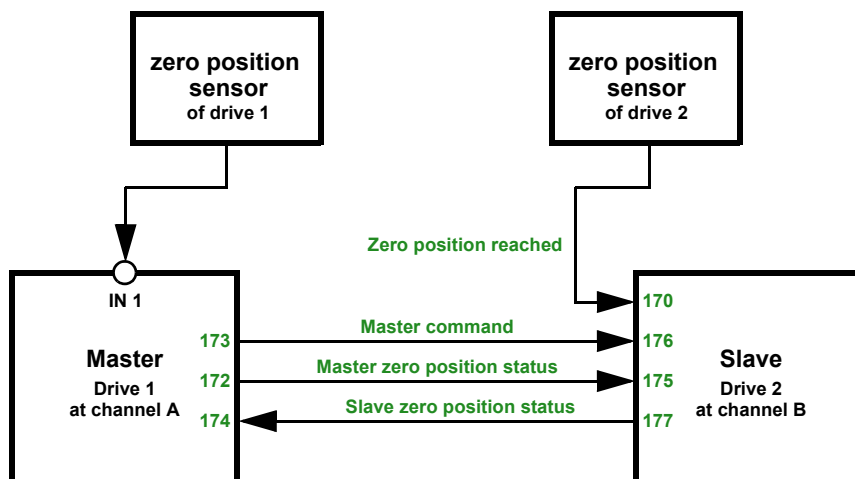

**Actuator A is Master, zero position sensor via bus,
Actuator B is Slave, zero position sensor at input 1 of the actuator:**

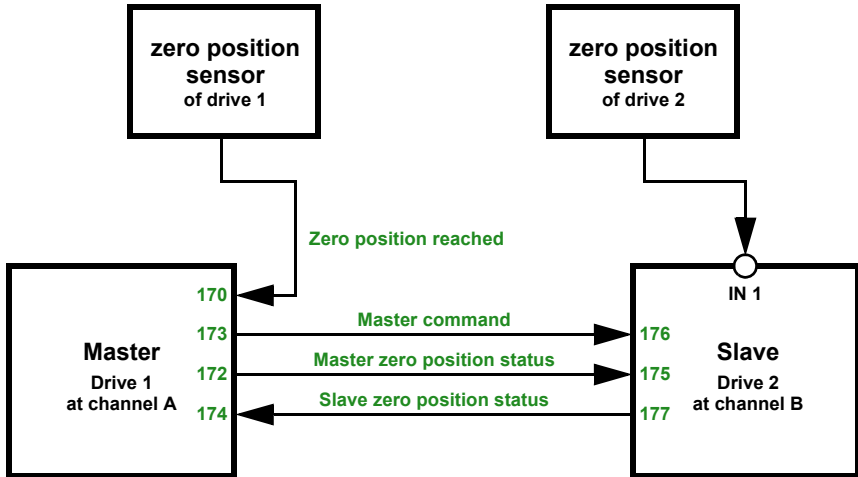

**Drive channel A is Master, zero position sensor via bus,
drive channel B is Slave, zero position sensor via bus:**

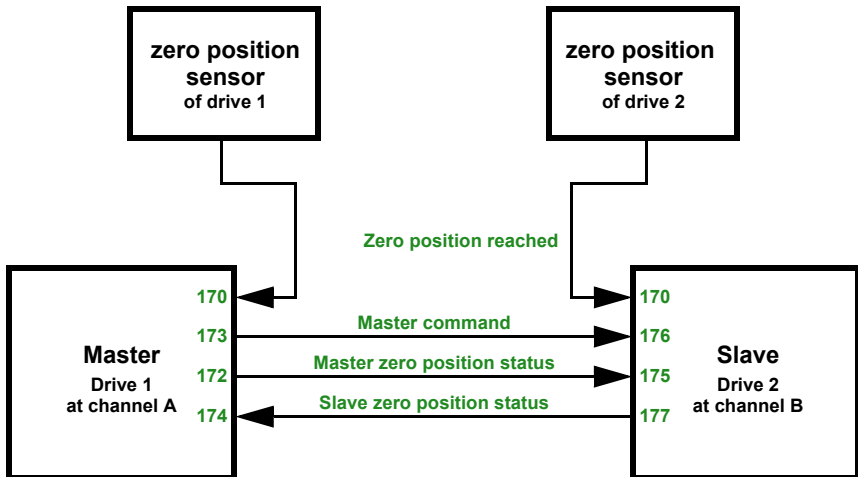

5.2.4. Output channel with switch function

Correlation connection – time switch – block

Application 1: Staircase light at channel A1, that can only be switchable at twilight/night (linking) and that is turned on during a fire alarm (blocking).

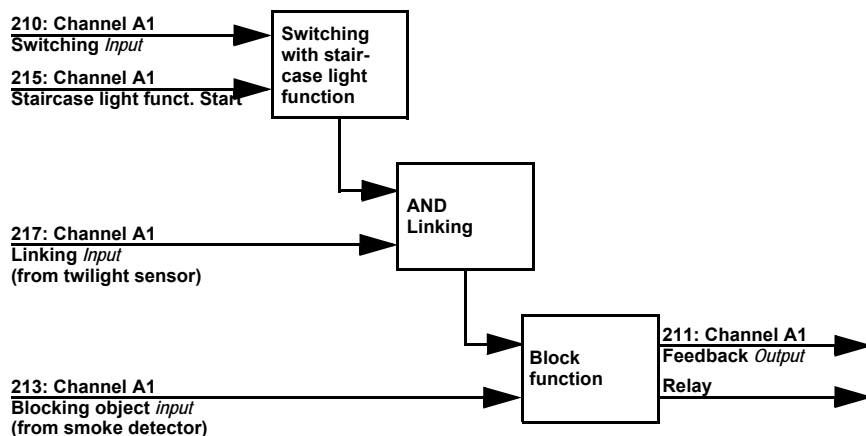

When switching via communication object "Channel A1 switch" (210), the light is turned on or off normally. When switching via object "Channel A1 staircase light function start" (215), the staircase light time function is activated. The time function has priority, i.e. the status triggered by normal switching is overwritten.

5.2.5. Channel settings – switch functions

If two switchable devices are connected to the output channel, two separate channels will appear (e.g. "Channel A1 – switch function" and "Channel A2 – switch function"). First set the general specifications for the connected device and, if necessary, activate the connections, time functions and blocking objects. A diagram is found in chapter *Correlation connection – time switch – block*, page 52.

Relay operation	<u>closer</u> • opener
Behavior for bus voltage failure	<ul style="list-style-type: none"> • <u>no change</u> • opened • closed
Behavior for bus voltage return	<ul style="list-style-type: none"> • <u>as before bus voltage failure</u> • no change • opened • closed
Behavior after reset and ETS download	<ul style="list-style-type: none"> • <u>opened</u> • closed

Use status object	<ul style="list-style-type: none"> • <u>no</u> • as an active feedback object • as a passive status object
Use connection function (see <i>Connection (switch functions)</i> , page 53)	<u>no</u> • yes
Use time function (see <i>On/Off switch delays, time switching (switch functions)</i> , page 53)	<ul style="list-style-type: none"> • <u>no</u> • as a switch on delay • as a switch off delay • as a switch on and off delay • as a staircase light timer
Use blocking object	<u>no</u> • yes

5.2.5.1. Connection (switch functions)

The menu item "connection" appears only for the settings for the switch function channel if selected "Use switch functions: Yes".

In the connection object ("Channel X connection") different communication objects can be linked with AND or OR. E.g. a light can only be switched on if the button input is active AND twilight is active.

Connection type	<u>AND</u> • OR
Value of the connection object after bus voltage returns	<u>0</u> • 1

5.2.5.2. On/Off switch delays, time switching (switch functions)

The menu item appears only for the settings for the switch function channel if a time function is chosen. The menu item has the same name as the selected function.

With the switch on and off delay, a switch can be used for example for a HVAC unit and light. Through the switch on delay the ventilator will only start if the light has already been turned on for a few minutes. The switch off delay effects that the ventilator will follow up if the button was operated again and the light is already off.

The staircase timer function makes sure for example that the light is on for a defined period of time and then turns off automatically.

Switch on delay

The switch on delay is set with a time basis and time factor (e.g. 1 min × 4 corresponds to 4 minutes). Additionally it is specified if the time interval for a repeat receipt of a switch-on telegram is extended ('triggered again', e.g. by pressing the button again) and what happens when a switch off telegram arrives from the bus.

Time basis	0.1 s • 1 s • <u>1 min</u> • 1 h
Time factor	4...255; <u>4</u>

Switch on delay cannot	be triggered again • <u>can be triggered again</u>
Off telegram during staircase light period affects	<u>nothing</u> • direct turn off

Switch off delay

The switch off delay is set with a time basis and time factor (e.g. 1 min × 4 corresponds to 4 minutes). Additionally it is specified if the time interval for a repeat receipt of a switch-off telegram is extended ("can be triggered again", e.g. by pressing the button again) and what happens when a switch off telegram arrives from the bus.

Time basis	0.1 s • 1 s • <u>1 min</u> • 1 h
Time factor	4...255; <u>4</u>
Switch on delay cannot	be triggered again • <u>can be triggered again</u>
On telegram during staircase light period affects	<u>nothing</u> • direct turn on

Staircase lighting timer

The staircase time switch sets with a time basis and time factor how long the light will remain on (e.g. 1 s × 10 corresponds to 10 seconds). Additionally it is specified if the time interval for a repeat receipt of a switch-on telegram is extended ("triggered again", e.g. by pressing the button again) and what happens when a switch off telegram arrives from the bus.

Time basis	0.1 s • <u>1 s</u> • 1 min • 1 h
Time factor	4...255; <u>10</u>
Staircase light time can	not be triggered again • <u>can be triggered again</u>
Off telegram during staircase light period affects	<u>nothing</u> • direct turn off

5.2.5.3. Blocking function (switch functions)

The menu item "blocking function" appears only for the settings for the switch function channel if selected "Use blocking functions: Yes".

The output channel can be blocked by a block telegram. What happens during the blocking, for bus voltage return and after the blocking is set here. The manual operation is then not possible for an active block.

The function can be used for example for a light, which is turned on when pressing a "panic button" (=trigger for blocking function) and cannot be turned off any longer.

Blocking function blocks for	0 • <u>1</u>
Value of the blocking object after bus voltage returns	<u>0</u> • 1
Response when blocking	no change • <u>opened</u> • closed
Response upon release	<u>follows switch command</u> • opened • closed

5.2.5.4. Button input (switch functions)

Depending on the model, there are no inputs, two or four inputs.

The inputs can be used as actuator button or bus button. If a temperature sensor (eg. T-NTC) is connected, the input is configured as a push button with function „temperature sensor (NTC)“.

Operating mode	
Use input 1 / 2 (3 / 4)	<ul style="list-style-type: none"> • no • as a bus button • <u>as an actuator switch</u>

Input as bus button

See *Input as bus button*, page 43.

Input as actuator button

If the input to the control of the device is used at this channel, then specify the button function.

Button function	<u>Switch</u> • Selector switch
-----------------	---------------------------------

If a button with switch function is assigned to the input, select the button function "Switch" and specify what happens when pressing/releasing the button and when to send.

Button function	Switch
Command when pressing the button	<ul style="list-style-type: none"> • <u>switch on</u> • switch off • nothing
Command when releasing the button	<ul style="list-style-type: none"> • switch on • <u>switch off</u> • nothing

The input can be blocked using a blocking object. Set what happens when (de)activating the block. No operation is possible for an active block.

Use blocking object	<u>No</u> • Yes
---------------------	-----------------

Use blocking object	Yes
Once when activating the blocking	<ul style="list-style-type: none"> • <u>switch on</u> • switch off • nothing
Once when deactivating the blocking	<ul style="list-style-type: none"> • switch on • <u>switch off</u> • nothing • evaluate current state

If a button with selector switch function is assigned to the input, select the bus function "Selector switch" and specify what happens when pressing and releasing the button.

Button function	Selector switch
Command when pressing the button	<ul style="list-style-type: none"> • <u>switch over</u> • nothing
Command when releasing the button	<ul style="list-style-type: none"> • switch over • <u>nothing</u>

The input can be blocked using a blocking object. No operation is possible for an active block.

Use blocking object	<u>No</u> • Yes
---------------------	-----------------

5.3. Temperature threshold values

Activate the threshold values that you want to use here. The **Actuator KNX S1-BA4** provide four threshold values for temperature.

Use threshold value 1/2/3/4	Yes • <u>No</u>
-----------------------------	-----------------

5.3.1. Temperature threshold value 1, 2, 3, 4

Threshold value:

Set the threshold values directly in the application program using parameters, or define them via the bus using a communications object.

Threshold value setpoint using parameter:

Set the threshold values and hysteresis directly.

Threshold value setpoint using	Parameter • Communications object
<i>Temperature:</i> Threshold value in 0.1°C	-300 ... 800; <u>200</u>
<i>Humidity:</i> Threshold value in % rH	0...100; <u>70</u>
Hysteresis of the threshold value in %	0 ... 50; <u>20</u>

Threshold value setpoint using a communications object:

Beforehand, enter how the threshold value will be received from the bus. Basically, a new value can be received, or simply a command to increase or decrease.

During initial commissioning, a threshold value must be defined which will be valid until the 1st communication of a new threshold value. For units which have already been taken into service, the last communicated threshold value can be used. Basically, a temperature range is given in which the threshold value can be changed (object value limit).

A set threshold value will be retained until a new value or a change is transferred. The current value is saved in EEPROM, so that this is retained in the event of a power supply failure and will be available once the power supply is restored.

Threshold value setpoint using	Parameter • Communications object
The last communicated value should be retained	<ul style="list-style-type: none"> • <u>never</u> • after restoration of power • after restoration of power and programming
Start threshold value in 0.1°C valid till 1st communication	-300 ... 800; <u>200</u>
Object value limit (min) in 0.1°C	<u>-300</u> ...800
Object value limit (max) in 0.1°C	-300... <u>800</u>
Type of threshold change	<u>Absolute value</u> • Increase/decrease
Step size (upon increase/decrease change)	0.1°C • ... • <u>1°C</u> • ... • 5°C
Hysteresis of the threshold value in %	0 ... 50; <u>20</u>

Switching output:

Set the behaviour of the switching output when a threshold value is exceeded/ undercut. The output switching delay can be set using objects or directly as a parameter.

When the following conditions apply, the output is (LV = Threshold value)	<ul style="list-style-type: none"> • LV above = 1 LV - hysteresis below = 0 • LV above = 0 LV - hysteresis below = 1 • LV below = 1 LV + hysteresis above = 0 • LV below = 0 LV + hysteresis above = 1
Delays can be set via objects (in seconds)	<u>No</u> • Yes
Switching delay from 0 to 1 (when delay is not set using objects)	<u>None</u> • 1 s • 2 s • 5 s • 10 s • ... • 2 h
Switching delay from 1 to 0 (when delay is not set using objects)	<u>None</u> • 1 s • 2 s • 5 s • 10 s • ... • 2 h
Switching output sends	<ul style="list-style-type: none"> • <u>on change</u> • on change to 1 • on change to 0 • on change and periodically • on change to 1 and periodically • on change to 0 and periodically
Send cycle (is only sent if "periodically" is selected)	<u>5 s</u> • 10 s • 30 s... • 2 h

Block:

The switching output can be blocked using an object. Define specifications here for the behaviour of the output when blocked.

Use switching output block	<u>No</u> • Yes
Analysis of the blocking object	<ul style="list-style-type: none"> • <u>At value 1: block</u> <u>At value 0: release</u> • <u>At value 0: block</u> <u>At value 1: release</u>
Blocking object value before 1st communication	<u>0</u> • 1
Behaviour of the switching output	
With blocking	<ul style="list-style-type: none"> • <u>Do not send message</u> • send 0 • send 1
On release (with 2 seconds release delay)	[Dependent on the "Switching output sends" setting]

The behaviour of the switching output on release is dependent on the value of the parameter "Switching output sends" (see "Switching output")

Switching output sends on change	<ul style="list-style-type: none"> • Do not send message • Send switching output status
Switching output sends on change to 1	<ul style="list-style-type: none"> • Do not send message • If switching output = 1 → send 1
Switching output sends on change to 0	<ul style="list-style-type: none"> • Do not send message • If switching output = 0 → send 0
Switching output sends on change and periodically	Send switching output status
Switching output sends on change to 1 and periodically	If switching output = 1 → send 1
Switching output sends on change to 0 and periodically	If switching output = 0 → send 0



Elsner Elektronik GmbH Control and Automation Engineering

Sohlengrund 16
75395 Ostelsheim
Germany

Phone +49 (0) 70 33 / 30 945-0 info@elsner-elektronik.de
Fax +49 (0) 70 33 / 30 945-20 www.elsner-elektronik.de

Technical support: +49 (0) 70 33 / 30 945-250