

ALLinBOX 1612 v2/88/46/Hospitality

Multifunction device with power supply, KNX-IP Interface, outputs, inputs, and logical module

ZPR1612V2

ZPR88

ZPR46

ZPRHP

Application program version: [1.5]

User manual edition: [1.5]_a

www.zennio.com

CONTENTS

Contents	2
Document Updates	3
1 Introduction	4
1.1 ALLinBOX 1612 v2 / ALLinBOX 88 / ALLinBOX 46 / Hospitality	4
1.2 Installation.....	6
1.3 Start-Up and Power Loss.....	8
1.4 LED Indicators.....	9
1.5 Hard Reset to IP Factory Defaults	11
1.6 Hard Reset power supply	12
2 Configuration.....	13
2.1 KNX to IP Interface	13
2.2 Programmer	14
2.2.1 Parallel Downloads.....	15
2.3 Additional Individual Addresses (Tunneling Addresses)	17
2.4 General.....	18
2.5 Inputs	21
2.5.1 Binary Input.....	21
2.5.2 Temperature Probe.....	21
2.5.3 Motion Detector	21
2.6 Outputs.....	22
2.6.1 ALLinBOX 1612 v2 / 88 / 46	22
2.6.2 ALLinBOX Hospitality.....	24
2.7 Thermostats	25
2.8 Master Light	26
2.9 Logic Functions.....	29
2.10 Scene Timing	30
2.11 Manual Control Through IR Remote Control	32
2.12 NTP	31
ANNEX I. Communication Objects.....	36

DOCUMENT UPDATES

Version	Changes	Page(s)
	New devices: ALLinBOX Hospitality	-
[1.5] _a	Changes in the application program: <ul style="list-style-type: none">• Date/time synchronisation via NTP• Optimisation of the shutters, standard thermostat, hospitality thermostat and logic functions modules.	37
[1.4] _b	New devices: ALLinBOX 88 y ALLinBOX 46.	-

1 INTRODUCTION

1.1 ALLinBOX 1612 v2 / ALLinBOX 88 / ALLinBOX 46 / Hospitality

ALLinBOX 1612 v2 / ALLinBOX 88 / ALLinBOX 46 / ALLinBOX Hospitality are a versatile KNX actuators featuring a wide variety of functions.

Functions		1612 v2	88	46	Hospitality
Relay Outputs	Shutter Channels	8	4	2	✘
	Individual Outputs	16	8	4	1
	Fan Coil Modules	2 (2/4-pipe)	1 (2/4-pipe)	1 (2/4-pipe)	1 (2-pipe)
Inputs	Temperature Probes	12	8	6	6
	Binary Inputs	12	8	6	6
	Motion Detectors	12	8	6	6
Thermostats	Standard	4	4	4	✘
	Hospitality	4	4	4	2

In addition to these functions, there are others, common to all ALLinBOX:

- **20 customisable, multi-operation logic functions.**
- **2 master light control instances** for an easy, out-of-the-box control of a set of luminaires (or functionally equivalent devices) one of which acts as a general lamp and the others as secondary lamps.
- **Manual operation / supervision** of the 16/8/4 relay outputs through infrared.
- **Scene-triggered action control**, with an optional delay in the execution.
- **Relay switches counter.**
- **Heartbeat** or periodical “still-alive” notification.
- **IP interface**

- Up to 5 parallel connections from ETS for programming and monitoring.
- High-capacity buffer
- **7 light indicators** (LEDs): 2 state indicators for the power supply (power and overload), 1 power supply factory reset indicator, 2 state indicators for the lines (bus and Ethernet), 1 IP factory reset indicator, and 1 additional indicator for the programming mode.
- **29V power supply and 640/320/250/250 mA respectively.** It is divided between an auxiliary output of 29V and a bus output with KNX coil include. The nominal input of the power supply must be universal 110/230V ~ 50/60Hz.

1.2 INSTALLATION

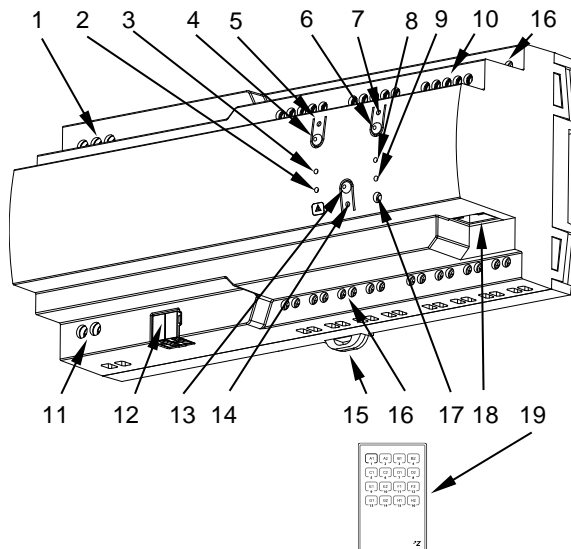

1. Main Power Supply.
2. Overload Status LED.
3. Power Supply Status LED.
4. Reset Button.
5. Reset Status LED.
6. IP Factory Reset Button.
7. IP Factory Reset LED.
8. Ethernet LED.
9. KNX Bus LED.
10. Analog/Digital Inputs.
11. Auxiliary Power Output.
12. KNX Connector.
13. Programming/Test Button.
14. Programming/Test LED.
15. Fixing Clamp.
16. Outputs.
17. IR Input.
18. Ethernet Connector.
19. Remote Control (not included).

Figure 1. ALLinBOX 1612 v2 elements scheme.

Note: the above figure is entirely analogous for ALLinBOX 88, ALLinBOX 46 and ALLinBOX Hospitality.

Figure 1 shows a scheme of ALLinBOX 1612 v2 with all the LED indicator and required connections. ALLinBOX has its own power supply, so it does not need an additional one and it serves to supply the rest of the devices through the KNX bus.

The couple LNX twisted-pair (TP) line and LAN network, the KNX bus (12) and Ethernet (18) cables must be connected. After the connection, the device can be conveniently mounted on the DIN rail by the usual procedure.

The main elements of the device are described below.

- **Test/Prog. Pushbutton (13):** a short press on this button sets the device into the programming mode, and the associated LED (14) lights in red.

Note: *if this button is held while plugging the device into the KNX bus, the device will enter into **safe mode**. In such case, the LED will blink in red every 0.5 seconds.*

- **Outputs (16):** output ports for the insertion of the stripped cables of the systems being controlled by the actuator (see section 2.6). Please secure the connection by means of the on-board screws.

- **Inputs (10):** input ports for the insertion of the stripped cables of external elements such as switches / motion detectors / temperature probes, etc. One of the two cables of each element need to be connected to one of the slots labelled “1” to “12” / “1” to “8” / “1” to “6”, while the other cable should be connected to the slot labelled as “C”. Note that all the external input devices share the “C” slot for one of the two cables. Please secure the connection by means of the on-board screws.

- **LEDs (2, 3, 5, 7, 8 y 9) and reset buttons (4 y 6):** the behaviour will be described in section 1.4.

- **Main Power Supply (1):** slots for the connection of the voltage wires (phase, neutral and ground).

To get detailed information about the technical features of this device, as well as on the installation and security procedures, please refer to the corresponding **Datasheet**, bundled with the original package of the device and also available at www.zennio.com.

1.3 START-UP AND POWER LOSS

During the start-up of the device, the Test/Prog. LED will blink in blue colour for a few seconds before ALLinBOX is ready. External orders will not be executed during this time, but they will do it afterwards.

Depending on the configuration, some specific actions will also be performed during the start-up. For example, the integrator can set whether the output channels should switch to a particular state and whether the device should send certain objects to the bus after the power recovery. Please consult the next sections of this document for further details.

On the other hand, when a bus power failure takes place, ALLinBOX will interrupt any pending actions and will save its state so it can be recovered once the power supply is restored.

For safety reasons, if a power loss takes place, all **shutter channels** will be stopped (i.e., the relays will open), while the individual outputs and fan coil contacts will switch to the specific state configured in ETS (if any).

1.4 LED INDICATORS

ALLinBOX incorporates 7 LED lights on the top of the device that make it easy to monitor the status of the buses and to detect typical communication problems, as detailed below.

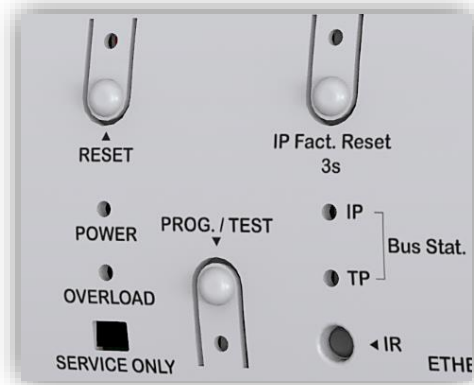

Figure 2. LEDs

- **KNX Line Status LED (TP):** shows the status of the KNX bus.

- OFF: KNX line is not powered.
- ON (green) = KNX line is powered.

Note: *the update of the LED status can be delayed a few seconds after the trigger event, e.g., after the disconnection of the main power supply.*

- **Ethernet Line Status LED (IP):** shows the status of the Ethernet line.

- OFF: IP address missing, or IP line not connected.
- ON (green): Ethernet connection OK and IP address correctly assigned.

- **Power Supply Status LED (POWER):** shows the status of the power supply.

- OFF: the device is not powered.
- ON (green): device with voltage.
- BLINKING (green): short circuit on the KNX bus / “Reset” button press.

● **Overload LED (OVERLOAD):** notifies a high consumption on the KNX bus and/or the auxiliary power output line.

- OFF: normal power consumption on the KNX bus and/or the auxiliary power output line.
- ON (red): overload on bus KNX and/or auxiliary power output line *.
- BLINKING (red): cut-off due to overload on the KNX bus and/or the auxiliary power output line *.

* Reduce the load on the bus and/or the auxiliary power output lines until its total consumption does not exceed the maximum current specified.

● **Programming LED:**

- OFF: normal operation.
- ON (red): programming mode active.
- BLINKING (red): safe mode active.
- ON (green): test mode active.
- BLINKING (blue): the device is initializing.

● **IP Factory Reset LED:**

- OFF: normal operation.
- ON (red): IP restored by DHCP.
- ON (green): static IP (of ETS configuration) restored.
- ON (yellow): IP restored by APIPA.

Note: Please refer to section 1.5 for further details.

● **Reset LED:**

- OFF: normal operation.
- BLINKING (red): "Reset" button is pressed / short circuit on the KNX bus.

1.5 HARD RESET TO IP FACTORY DEFAULTS

The objective of the IP factory reset is to locate a device that is not accessible on a local network due to an IP configuration loss. Once the device is accessible, it will be necessary a new ETS download to introduce the desire IP configuration.

By pressing the "IP Factory Reset" button for three seconds:

- The device will adopt an **IP address via the DHCP server**.
 - If the DHCP client does not obtain a valid IP address (after several attempts), then the device will be assigned an **IP address via the AutoIP (APIPA)**¹ protocol.

The factory reset indicator LED will light up in red.

If a **second-long press** is made on the "IP Factory Reset" button

- The device will adopt a **static IP address**.
 - If "Use a static IP address" has been chosen on the ETS configuration, the device will have the **configured IP**.
The factory reset led will light up in green.
 - On the other hand, if on the ETS configuration "Obtain an IP address automatically" has been chosen, the device will obtain an **IP by means of AutoIP (APIPA)**.
The factory reset indicator LED lights up in yellow.

The factory IP setting and the colour of the factory reset LED will remain until the device is restarted.

The following table summarizes the above:

Press	ETS Configuration	IP Configuration	LED
1st long press (3s)	Obtain an IP automatically	IP obtained by DHCP. (If a valid IP is not obtained → IP by APIPA)	Red
	Use a static IP address		
2nd long	Obtain an IP automatically	IP obtained by APIPA	Yellow

¹ Random static IP configuration in the range 169.254.1.0 - 169.254.254.255

press (3s)	Use a static IP address	Static IP of ETS configuration	Green
-------------------	-------------------------	--------------------------------	-------

1.6 HARD RESET POWER SUPPLY

If “Reset” button is **pressed**, a short circuit is made in the output power supply (29V). The device will not restart (and will not give power) until the button is released. The power supply status LED (POWER) will blink in green, and the Reset status LED will blink in red while the button is being pressed.

2 CONFIGURATION

To begin with the parameterisation process of the device, it is necessary, once the ETS program has been opened, to import the database of the product. Next, the device should be added to the project where desired.

The configuration of this device is done both in the parameters tab and in the ETS properties. The following sections explain how to configure each of the device functionalities.

2.1 KNX TO IP INTERFACE

ALLinBOX is an interface device intended for the **interconnection between a KNX bus and an Ethernet network (LAN)**.

The network parameters can be configured in the "IP" panel of the ETS "Properties":

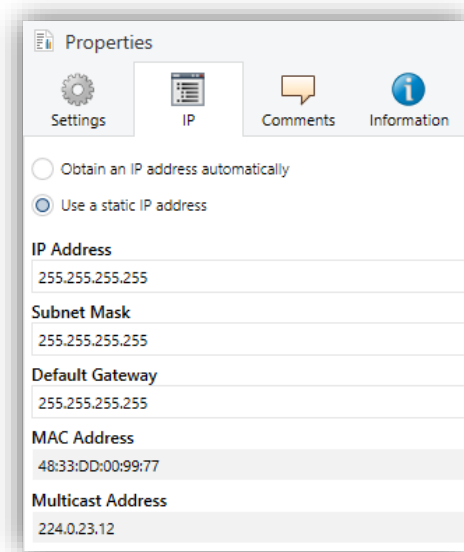

Figure 3 IP Configuration

- [Obtain an IP address automatically](#)². ALLinBOX will automatically take an IP address whenever there is a DHCP server in the local network to which it is connected.

² The default values of each parameter will be highlighted in blue in this document, as follows: [[default/rest of options](#)].

- **Use a static IP address.** If DHCP protocol is not used, the following properties must be set manually:
 - **IP Address** [0.0.0.0...[255.255.255.255](#)].
 - **Subnet Mask** [0.0.0.0...[255.255.255.255](#)].
 - **Default Gateway** [0.0.0.0...[255.255.255.255](#)].

Note: *If a static IP is configured, it is important to make sure that no other device on the network has this IP assigned to it and that it does not belong to the DHCP range configured for the router, otherwise connection problems with the ALLinBOX will be observed.*

In addition, the following information will be shown:

- **MAC Address.**
- **Multicast Address** [[224.0.23.12](#)]: IP address (reserved by the IANA organization for the KNXnet/IP protocol) used by ETS in this case, for discovering the available KNX-IP interfaces within the same network.

Once these properties have been entered an ETS programming is required to download the configuration to the device.

2.2 PROGRAMMER

ALLinBOX can be used in ETS as a **programming interface**. In addition to an IP address, they must be assigned a KNX individual address for this purpose.

Up to five simultaneous connections are allowed for performing downloads or for bus monitoring.

Note: *to detect the ALLinBOX as a programmer in ETS, it needs to be connected to the same IP network as the PC.*

To use a device as a programmer simply select it in the ETS "Bus" tab under Connections → Interfaces.

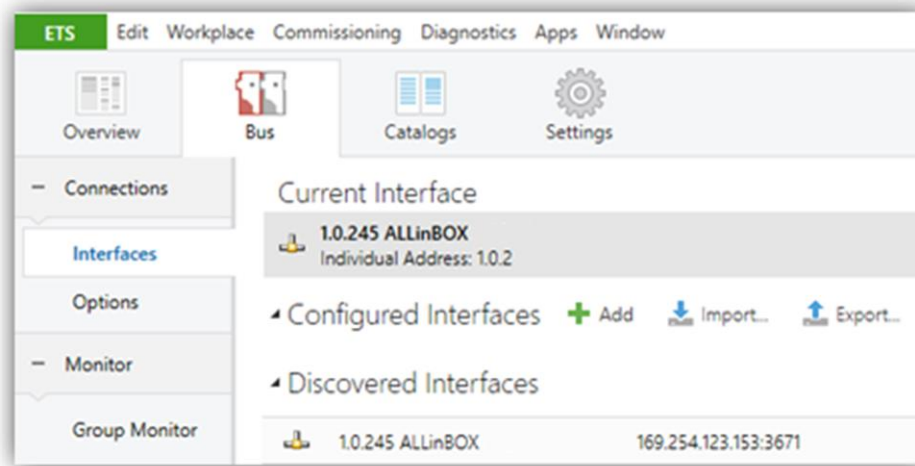

Figure 4. Selection of ALLinBOX in the Bus Connections tab in ETS.

Or by selecting it at the bottom left after opening a project in ETS.

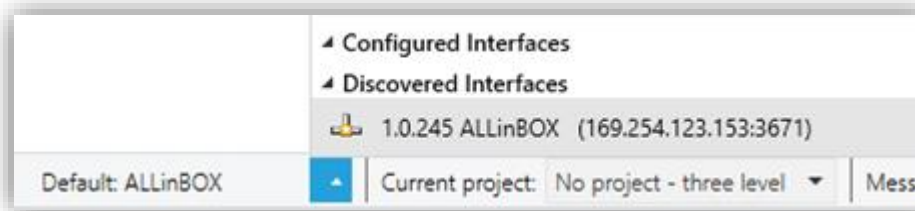

Figure 5. Selection of ALLinBOX in a ETS project.

Important: *If the ALLinBOX is selected as the programming interface to program itself it is recommended to first perform individual address download and then application download, rather than a complete download (complete download causes a device restart and therefore communication with ETS is lost and the download is cancelled).*

2.2.1 PARALLEL DOWNLOADS

ETS offers the option to perform multiple parallel downloads within the same project. This option is only available for connections via a KNX-IP router or a KNX-IP interface. Certain conditions must be met:

- Each download must be performed on a different line.
- For each line, it is necessary to select one **ALLinBOX** to perform the download.

Note: There is a restriction: parallel downloads are **not available to download physical addresses**. When performing this type of downloads, the link device used by ETS is not the one configured for the line but the general one.

In "Settings" panel, in "Properties" of the line, the connection can be selected.

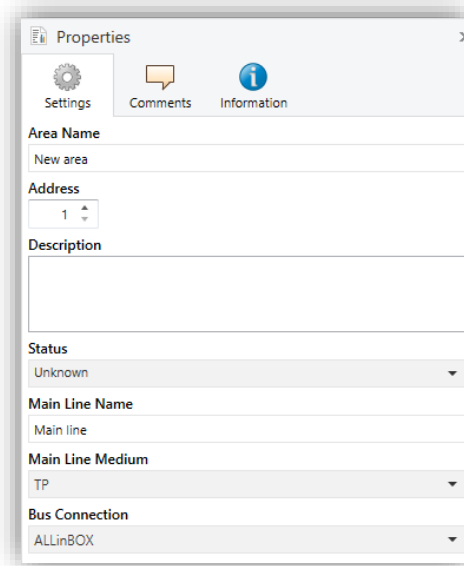

Figure 6 ETS5 parallel downloads configuration.

Note: once the connection has been selected, it will not be available for the other lines.

2.3 ADDITIONAL INDIVIDUAL ADDRESSES (TUNNELING ADDRESSES)

ALLinBOX requires a specific individual address when acting as a programming interface (tunnelling) other than the address of the device itself. Up to five simultaneous connections are possible, which implies that up to five different individual addresses must be configured.

After the individual ALLinBOX address has been set, the five tunnelling addresses are automatically set with consecutive values. These addresses can be changed at any time.

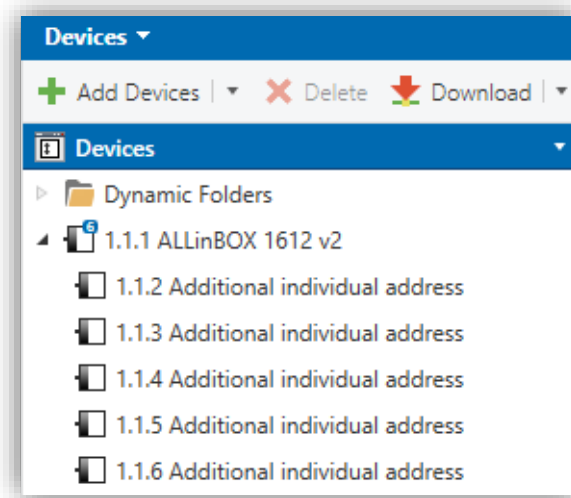

Figure 7 Set tunnelling addresses.

Note: *ALLinBOX tunnelling addresses must not match any of the addresses set to other devices on the system.*

2.4 GENERAL

After importing the corresponding database in ETS and adding the device into the topology of the desired project, the configuration process begins by entering the Parameters tab of the device.

ETS PARAMETERISATION

The "General" tab contains general settings. From this screen it is possible to activate/deactivate all the required functionality.

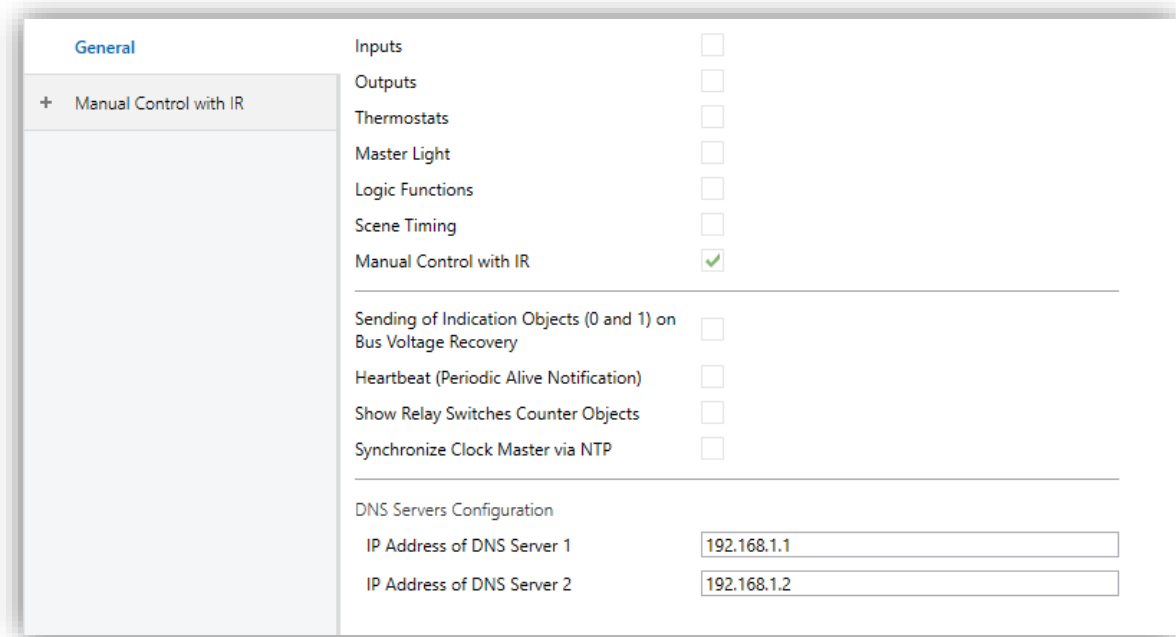

Figure 8. General screen

- **Inputs** [[disabled/enabled](#)]: enables or disables the "Inputs" tab on the left menu. See section 2.5 for more details.
- **Outputs** [[disabled/enabled](#)]: enables or disables the "Outputs" tab on the left menu. See section 2.6 for more details.
- **Thermostats** [[disabled/enabled](#)]: enables or disables the "Thermostats" tab on the left menu. See section 2.7 for more details.
- **Master Light** [[disabled/enabled](#)]: enables or disables the "Master Light" tab on the left menu. See section 2.8 for more details.

- **Logic Functions** [[disabled/enabled](#)]: enables or disables the “Logic Functions” tab on the left menu. See section 2.9 for more details.
- **Scene Timing** [[disabled/enabled](#)]: enables or disables the “Scene Timing” tab on the left menu. See section 2.10 for more details.
- **Manual Control with IR** [[disabled/enabled](#)]: enables or disables the “Manual Control” tab on the left menu. See section 2.11 for more details.
- **Sending of Indication Objects (0 and 1) on Bus Voltage Recovery** [[disabled/enabled](#)]: this parameter lets the integrator activate two new communication objects (“Reset 0” and “Reset 1”), which will be sent to the KNX bus with values “0” and “1” respectively whenever the device begins operation (for example, after a bus power failure). It is possible to parameterise a certain **delay** [[0...255](#)] to this sending.

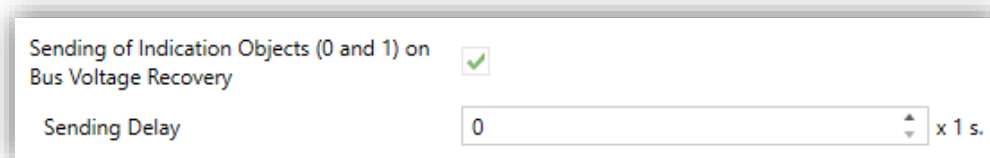

Figure 9. Sending of Indication objects on bus voltage recovery

- **Heartbeat (Periodic Alive Notification)** [[disabled/enabled](#)]: this parameter lets the integrator incorporate a one-bit object to the project (“[Heartbeat] Object to Send ‘1’”) that will be sent periodically with value “1” to notify that the device is still working (*still alive*).

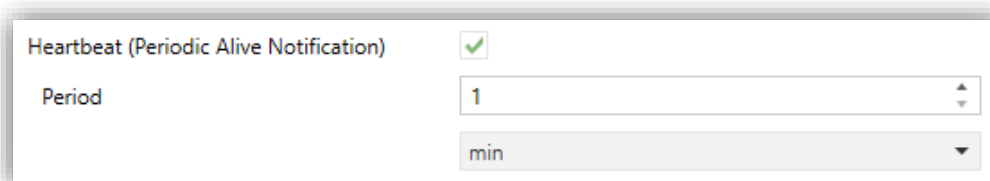

Figure 10. Heartbeat.

Note: The first sending after download or bus failure takes place with a delay of up to 255 seconds, to prevent bus overload. The following sendings match the period set.

- **Show Relay Switches Counter Objects** [[disabled/enabled](#)]: enables two communication objects to keep track of the number of switches performed by each of the relays ("**[Relay X] Number of Switches**") and the maximum number of switches carried out in a minute ("**[Relay X] Maximum Switches per Minute**").
- **Synchronize Clock Master via NTP** [[disabled/enabled](#)]: enables or disables the "NTP" tab in the tree on the left. For more information, see section 2.11.

Note: *This parameter must be enabled in the device that will be clock master so that there is only one clock master in the installation.*

- **DNS Servers Configuration:** numeric text fields to enter the IP address of two DNS servers:

➤ **IP Address of DNS Server 1 and 2** [[192.168.1.1](#), [192.168.1.2](#)].

Note: *The connection to the DNS server is necessary to ensure the correct functioning of the NTP servers (see section 2.11). As long as there is no connection to a DNS server, the date and time information will not be synchronized.*

2.5 INPUTS

ALLinBOX 1612 v2 / 88 / 46 / Hospitality incorporates **12 / 8 / 6 / 6 analogue/digital inputs**, each configurable as a:

- **Binary Input**, for the connection of a pushbutton or a switch/sensor.
- **Temperature Probe**, to connect a temperature sensor from Zennio.
- **Motion Detector**, to connect a motion detector from Zennio.

2.5.1 BINARY INPUT

Please refer to the “**Binary Inputs**” user manual, available under the ALLinBOX 1612 v2 / 88 / 46 / Hospitality product section at www.zennio.com.

2.5.2 TEMPERATURE PROBE

Please refer to the “**Temperature Probe**” user manual, available under the ALLinBOX 1612 v2 / 88 / 46 / Hospitality product section at www.zennio.com.

2.5.3 MOTION DETECTOR

Please refer to the “**Motion Detector**” user manual, available under the ALLinBOX 1612 v2 / 88 / 46 / Hospitality product section at www.zennio.com.

2.6 OUTPUTS

In the case of the outputs, we will distinguish between the devices ALLinBOX 1612 v2 / 88 / 46 (explained in section 2.6.1) and the device ALLinBOX Hospitality (explained in section 2.6.2).

2.6.1 ALLINBOX 1612 v2 / 88 / 46

ALLinBOX 1612 v2 / 88 / 46 incorporates **16 / 8 / 4 relay outputs**, each configurable as a:

- **Individual binary output**, which provides an independent control of a load (up to 16 / 8 / 4 different loads can be controlled).
- **Shutter channel**, which enables the control of the motion of one blind (up to 8 / 4 / 2 blinds can be controlled).
- **Fan Coil modules**, to control fan coils fan and valves (up to 2 / 1 / 1³ modules can be controlled).

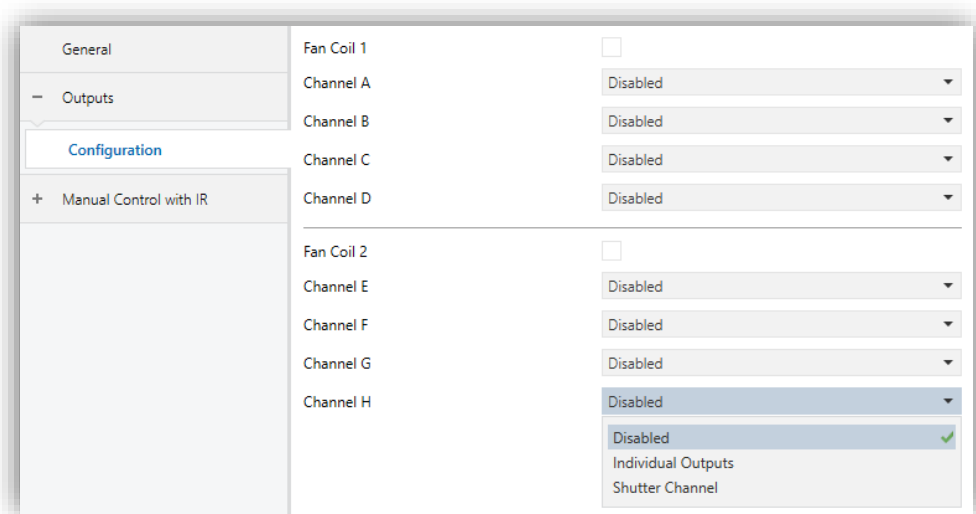

Figure 11. Outputs screen.

Each channel can be configured through the drop-down list as two independent **binary outputs** or as a **shutter channel** (which makes use of both relays).

ALLinBOX incorporates **fan coil control modules**, which will be responsible for operating the relays that open and close the water pipe valves (either one three-point

³ Please note that ALLinBOX 46, as it has fewer outputs, not all functions associated with the valves can be configured. See Table 1 for further details.

valve, one or up to two on-off valves depending on the ALLinBOX and its parameterisation), and the relays that set the fan speed level. The latter can be achieved through **relay accumulation** (more relays closed means a higher fan speed) or through **relay commutation** (one specific relay will be available per level), depending on the configuration. The relays distribution for the valves control is shown in the following table for every possible parameterisation and ALLinBOX type:

Fan coil	Number pipes	Valve type	Output	Action	ALLinBOX		
					1612 v2	88	46
1	4	On / Off	B2	Cooling Valve	✓	✓	✗
			C1	Heating Valve	✓	✓	✗
		Three-point	B2	Opening Cooling Valve	✓	✓	✗
			C1	Closing Cooling Valve	✓	✓	✗
			C2	Opening Heating Valve	✓	✓	✗
			D1	Closing Heating Valve	✓	✓	✗
	2	On / Off	B2	Cooling and/or Heating Valve	✓	✓	✓
			Three-point	B2	Opening Valve for both modes	✓	✓
		C1		Closing Valve for both modes	✓	✓	✗
		2	4	On / Off	F2	Cooling Valve	✓
G1	Heating Valve				✓	✗	✗
Three-point	F2			Opening Cooling Valve	✓	✗	✗
	G1			Closing Cooling Valve	✓	✗	✗
	G2			Opening Heating Valve	✓	✗	✗
	H1			Closing Heating Valve	✓	✗	✗
2	On / Off		F2	Cooling and/or Heating Valve	✓	✗	✗
			Three-point	F2	Opening Valve for both modes	✓	✗
	G1			Closing Valve for both modes	✓	✗	✗

Table 1. Actions performed by the binary outputs associated to the valve control depending on the ALLinBOX.

For detailed information about the functionality and the configuration of the related parameters, please refer to the following specific manuals, all of them available under the ALLinBOX product section at the Zennio homepage (www.zennio.com):

- **Individual outputs.**
- **Shutter channels.**
- **'Relays' Fan coil.**

2.6.2 ALLINBOX Hospitality

ALLinBOX Hospitality incorporates one block of relay outputs to control a **fan coil module** and one additional **individual binary output**.

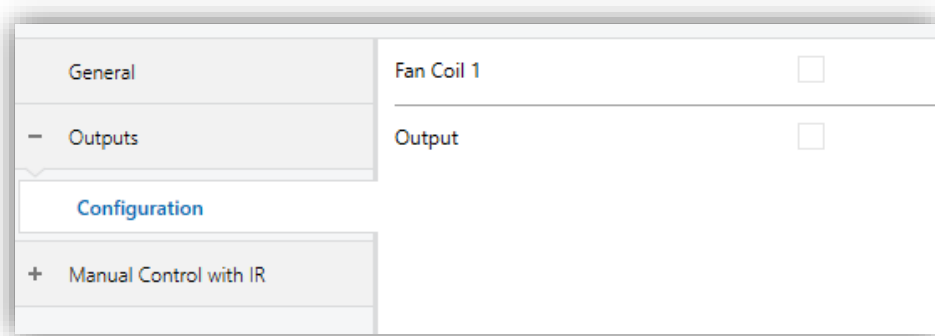

Figure 12. ALLinBOX Hospitality outputs screen.

The **fan coil module** is intended to operate the relay that open and close a water pipe valve (one on-off valve only), and the relays that set the fan speed level. The latter can be achieved through **relay accumulation** (more relays closed means a higher fan speed) or through **relay commutation** (one specific relay will be available per level), depending on the configuration.

The **individual output** provides an independent binary control of a load and offers many different options like timers, alarms, lock, etc.

For detailed information about the functionality and the configuration of the related parameters, please refer to the following specific manuals, all of them available under the ALLinBOX product section at the Zennio homepage (www.zennio.com):

- **Individual outputs.**
- **'Relays' Fan coil.**

2.7 THERMOSTATS

ALLinBOX 1612 v2 / 88 / 46 implements **four standard thermostats and four Hospitality thermostats** which can be enabled and configured independently.

ALLinBOX Hospitality implements **two Hospitality thermostats** which can be enabled and configured independently.

The use of the Hospitality thermostat is only recommended for hotel rooms.

Please refer to the specific “**Thermostat**” or “**Hospitality Thermostat**” user manual available under the ALLinBOX product section at the Zennio homepage (www.zennio.com) for detailed information about the functionality and the configuration of the related parameters.

2.8 MASTER LIGHT

This function brings the option to monitor the state of 2 master light modules up to 12 light sources (or even more, if the Master Light controls from multiple Zennio devices are linked together) or of any other elements whose state is transmitted through a binary object and, depending on those states, perform a **master order** every time a certain trigger signal (again, a binary value) is received through a specific object.

Such master order will consist in:

- A **general switch-off** order, if at least one of the up to twelve status objects is found to be on.
- A **courtesy switch-on** order, if none of the up to twelve status objects is found to be on.

Note that the above switch-off and switch-on orders are not necessarily a binary value being sent to the bus – it is up to the integrator the decision of what to send to the KNX bus in both cases: a shutter order, a thermostat setpoint or mode switch order, a constant value, a scene... Only the trigger object and the twelve status objects are required to be binary (on/off).

The most typical scenario for this Master Light control would be a hotel room with a master pushbutton next to the door. When leaving the room, the guest will have the possibility of pressing on the master pushbutton and make all the lamps turn off together. Afterwards, back on the room and with all the lamps off, pressing on the same master pushbutton will only make a particular lamp turn on (e.g., the closest lamp to the door) – this is the courtesy switch-on.

Besides, it is possible to concatenate two or more Master Light modules by means of a specific communication object which represents the general state of the light sources of each module. Thereby, it is possible to expand the number of light sources by considering the general state of one module as an additional light source for another.

ETS PARAMETERISATION

Once the Master Light function has been enabled, a specific tab will be included in the menu on the left. This new parameter screen (Figure 13) contains the following options:

Section	Parameter	Value
General	Number of State Objects	1
	Trigger Value	0/1
General Switch Off	Delay	0 x 1 s
	Binary Value	<input checked="" type="checkbox"/>
	Scaling	<input type="checkbox"/>
	Scene	<input type="checkbox"/>
Courtesy Switch On	Delay	0 x 1 s
	Binary Value	<input checked="" type="checkbox"/>
	Scaling	<input type="checkbox"/>
	Scene	<input type="checkbox"/>

Figure 13. Master Light

- **Number of State Objects** [1...12]: defines the number of 1-bit status objects required. These objects are called “[ML] Status Object *n*”.

In addition, the general status object (“[ML] General status”) will always be available in the project topology. It will be sent to the bus with a value of “1” whenever there is at least one of the above state objects with such value. Otherwise (i.e., if none of them has a value of “1”), it will be sent with a value of “0”.

- **Trigger Value** [0 / 1 / 0/1]: sets the value that will trigger, when received through “[ML] Trigger”, the master action (the general switch-off or the courtesy switch-on).

- **General Switch-Off.**

- **Delay** [0...255] [x 1 s]: defines a certain delay (once the trigger has been received) before the execution of the general switch-off.
- **Binary Value** [disabled/enabled]: if checked, object “[ML] General Switch-off: Binary Object” will be enabled, which will send one “0” whenever the general switch-off takes off.

- **Scaling** [[disabled/enabled](#)]: if checked, object “[ML] General Switch-off: Scaling” will be enabled, which will send a percentage value (configurable in **Value** [[0...100](#)]) whenever the general switch-off takes off.
- **Scene** [[disabled/enabled](#)]: if checked, object “[ML] General Switch-off: Scene” will be enabled, which will send a scene run / save order (configurable in **Action** [[Run / Save](#)] and **Scene Number** [[1...64](#)]) whenever the general switch-off takes off
- **HVAC** [[disabled/enabled](#)]: if checked, object “[ML] General Switch-off: HVAC mode” will be enabled, which will send an HVAC thermostat mode value (configurable in **Value** [[Auto / Comfort / Standby / Economy / Building Protection](#)]) whenever the general switch-off takes off

Note: *the above options are not mutually exclusive; it is possible to send values of different nature together.*

● **Courtesy Switch-On:**

The parameters available here are entirely analogous to those already mentioned for General Switch-Off. However, in this case the names of the objects start with “[ML] Courtesy Switch-On (...)”. On the other hand, sending **scene save orders** is not possible for the courtesy switch-on (only orders to play scenes are allowed).

Note: *object “[ML] Courtesy Switch-On: Binary Object” sends the value “1” (when the courtesy switch-on takes place), in contrast to object “[ML] General Switch-Off: Binary Object”, which sends the value “0” (during the general switch-off, as explained above).*

2.9 LOGIC FUNCTIONS

This module makes it possible to perform numeric and binary operations to incoming values received from the KNX bus, and to send the results through other communication objects specifically enabled for this purpose.

ALLinBOX can implement **up to 20 different and independent functions**, each of them entirely customisable and consisting of **up to 4 consecutive operations each**.

The execution of each function can depend on a configurable **condition**, which will be evaluated every time the function is **triggered** through specific, parameterisable communication objects. The result after executing the operations of the function can also be evaluated according to certain **conditions** and afterwards sent (or not) to the KNX bus, which can be done every time the function is executed, periodically or only when the result differs from the last one.

Please refer to the “**Logic Functions**” user manual available under the ALLinBOX product section at the Zennio homepage (www.zennio.com) for detailed information about the functionality and the configuration of the related parameters.

2.10 SCENE TIMING

The scene timing enables the **imposition of delays over the scenes** of the outputs. These delays, defined in parameters, are applied on the execution of one or more scenes that may have been configured.

Please bear in mind that, as multiple delayed scenes can be configured for each individual output / shutter channel / fan coil module, in case of receiving an order to execute one of them when **a previous temporisation is still pending** for that output / channel / module, such temporisation will be interrupted and only the delay and the action of the new scene will be executed.

ETS PARAMETERISATION

Prior to setting the **scene timing**, it is necessary to have one or more scenes configured in some of the outputs. When entering the Configuration window under Scene Timing, all configured scenes will be listed, together with a few checkboxes to select which of them need to be temporised, as shown in Figure 14:

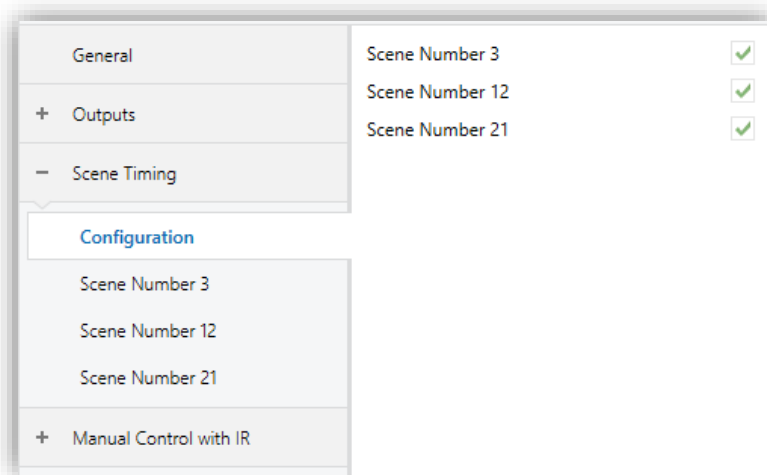

Figure 14. Scene Timing

Enabling a certain **Scene Number n** [[disabled/enabled](#)] brings a new tab with such name to the menu on the left, from which it is possible to configure the temporisation of that scene for each of the outputs where it has been configured.

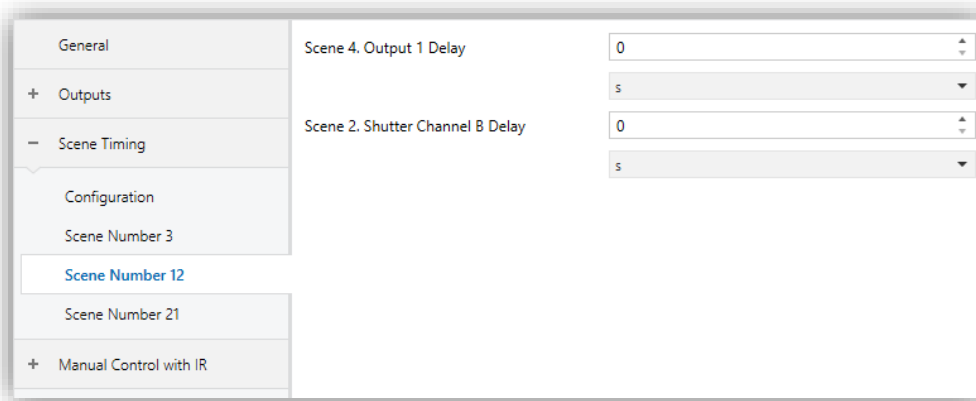

Figure 15. Configuring Scene Timing

Therefore, parameter **Scene n. Z Delay** $[0...3600][s]$ $[0...1440][min]$ $[0...24][h]$ defines the delay that will be applied to the action defined in Z (being Z a specific individual output, shutter channel or fan coil module) for the execution of scene m.

Note: *In the configuration of a scene of an output / shutter channel / fan coil module it is possible to parameterise several scenes with the same scene number. This means that several delay parameters associated with the same output appear in the configuration tab of the delays of that scene. With this parameterisation, the behaviour will be as follows: the action and delay of the first scene parameterised with the same scene number will always prevail, where the highest priority scene is 1 (the first in the scene configuration tab) and the lowest priority is the last.*

2.11NTP

ALLinBOX can be configured as the installation master clock, it will send the date and time information to the rest of the devices of the installation. This information will be obtained from an NTP server.

Please refer to the specific manual “**NTP Clock**” (available under the ALLinBOX product section at Zennio homepage, www.zennio.com) for detailed information about the functionality and the configuration of the involved parameters.

2.12 MANUAL CONTROL THROUGH IR REMOTE CONTROL

ALLinBOX enables the manually switching the state of its output relays through the pushbuttons of an IR remote control. A specific pushbutton on the IR remote control is therefore available per output.

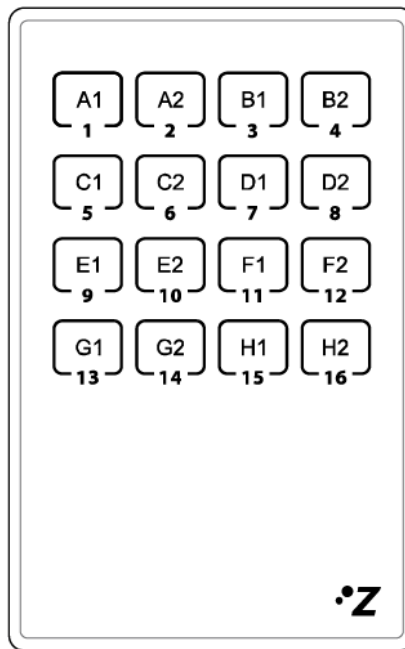

Figure 16. IR Remote Control

Manual operation has the mode, named as **Test On Mode** (for testing purposes during the configuration of the device). From ETS it will be possible to configure if the manual control will be available. Moreover, it is possible to enable a specific binary object for locking and unlocking the manual control in runtime.

Note:

- Switching to the **Test On mode** (unless disabled by parameter) needs to be done by long pressing the Prog/Test button (for at least three seconds), until the LED is no longer red and turns yellow. From that moment, once the button is released, the LED light will remain green to confirm that the device is in Test On mode. After that, an additional press will turn the LED yellow and then off, once the button is released. This way, the device leaves the Test On mode. Note that it will also leave this mode if a power failure takes place.

Test On Mode

After entering the Test On mode, it will only be possible to control the outputs through the IR remote control pushbuttons. Orders received through communication objects will be ignored, with independence of the channel or the output they are addressed to.

In order not to interfere with the normal operation of the device, and because the Test On mode is only intended to be used for testing purpose, when leaving the Test On mode **the device will recover its outputs to the previous state.**

Depending on the output parameterisation, the reactions to the button presses will differ.

- **Individual output:** short or long pressing the button will commute the on-off state of the relay.
- **Shutter channel⁴:** pressing the button will make the shutter drive move upward or downward (depending on the button) until the button is released again, thus ignoring the position of the shutter and the parameterised times.

Note: *after leaving the Test On mode, the status objects will recover the values they had prior to entering Test On. As the device is never aware of the actual position of the shutter (as the shutter drive does not provide any feedback), these values may not show the real position. This can be solved by performing a complete move-up or move-down order, or by calibrating the shutter position in the Test On mode until it matches the status objects.*

- **Fan Coil module:** the behaviour will be different for the buttons identified as fan and the identified as valve (see Table 1):
 - **Fan:** a short or long press will switch the relays to set the selected speed, unless it matches the current speed – in such case all the relays will be opened (speed 0).

Note: *the behaviour of the relays will depend on the parameterisation, i.e., on the **number of fan speeds**, on the **delay** between switches and on whether the control type is **accumulation** or **switching**.*
 - **Valve:** a short or long press will switch the current status of the relay and therefore of the valve.

⁴ In the case of ALLinBOX Hospitality, it is not possible to configure the outputs as a shutter channel, so what it is explained in this section does not apply.

- **Disabled output:** short and long presses will switch the state of the corresponding relay. In case this consists in closing the relay, then the remaining relays of its block will open, for safety reasons.

As described previously if the device is in Test On mode, any command sent from the KNX bus to the actuator will not affect the outputs and no status objects will be sent (only periodically timed objects such as Heartbeat or logic functions will continue to be sent to the bus) while Test ON mode is active. However, in the case of the "Alarm" and "Block" objects, even though in Test ON mode the actions received by each object are not taken into account, the evaluation of their status is carried out when exiting this mode; so that any change in the alarm status or blocking of the outputs while Test ON mode is active is taken into account when exiting this mode and is updated with the last status detected.

Important: *the device is factory delivered with all the output disabled, and with manual control Test On mode enabled.*

ETS PARAMETERISATION

When the option “**Manual Control with IR**” is enabled in the “General” screen (see section 2.4), a tab will be shown in the tree on the left.

The only two parameters are:

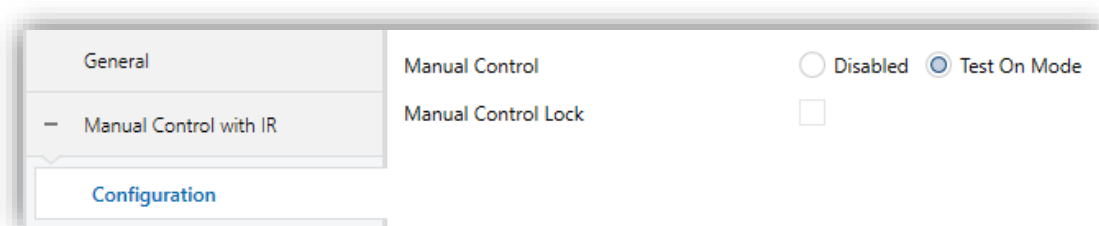

Figure 17. Manual Control

- **Manual Control** [Disabled / Test On Mode]: depending on the selection, the device will permit using the manual control under the Test On or have it disabled. Note that, as stated before, using Test On mode does require long pressing the Prog/Test button.
- **Manual Lock Control** [disabled/enabled]: unless the above parameter has been “Disabled”, the Lock Manual Control parameter provides an optional procedure for locking the manual control in runtime. When this checkbox is

enabled, object “**Manual Control Lock**” turns visible, as well as two more parameters:

- **Value** [0 = Lock; 1 = Unlock / 0 = Unlock; 1 = Lock]: defines whether the manual control lock/unlock should take place respectively upon the reception (through the aforementioned object) of values “0” and “1”, or the opposite.
- **Initialization** [Unlocked / Locked / Last Value]: sets how the manual control should remain after the device start-up (after an ETS download or a power failure). If “Last Value” is selected, on the very first start-up, this will be “Unlocked”).

ANNEX I. COMMUNICATION OBJECTS

- **“Functional range”** shows the values that, with independence of any other values permitted by the bus according to the object size, may be of any use or have a particular meaning because of the specifications or restrictions from both the KNX standard or the application program itself.
- **ALLinBOX Hospitality:** This device of the ALLinBOX family does not have the shutter channel nor standard thermostat functionalities, therefore it will not be possible to have the objects associated with these functionalities. These objects are those whose name begin with "[Cx]" in the case of blinds and shutter actuators and "[Tx]" for the standard thermostat.

Number	Size	I/O	Flags	Data type (DPT)	Functional Range	Name	Function
1	1 Bit		C - - T -	DPT_Trigger	0/1	Reset 0	Voltage Recovery -> Sending of 0
2	1 Bit		C - - T -	DPT_Trigger	0/1	Reset 1	Voltage Recovery -> Sending of 1
3	1 Bit	I	C - W - -	DPT_Enable	0/1	Lock Manual Control	0 = Lock; 1 = Unlock
	1 Bit	I	C - W - -	DPT_Enable	0/1	Lock Manual Control	0 = Unlock; 1 = Lock
4	1 Bit		C - - T -	DPT_Trigger	0/1	[Heartbeat] Object to Send '1'	Sending of '1' Periodically
5, 16, 27, 38	1 Byte	I	C - W - -	DPT_SceneControl	0-63; 128-191	[Ox] Scenes	0 - 63 (Execute 1 - 64); 128 - 191 (Save 1 - 64)
6, 17, 28, 39	1 Bit	I	C - W - -	DPT_BinaryValue	0/1	[Ox] On/Off	N.O. (0=Open Relay; 1=Close Relay)
	1 Bit	I	C - W - -	DPT_BinaryValue	0/1	[Ox] On/Off	N.C. (0=Close Relay; 1= Open Relay)
7, 18, 29, 40	1 Bit	O	C R - T -	DPT_BinaryValue	0/1	[Ox] On/Off (Status)	0=Output Off; 1=Output On
8, 19, 30, 41	1 Bit	I	C - W - -	DPT_Enable	0/1	[Ox] Lock	0=Unlock; 1=Lock
9, 20, 31, 42	1 Bit	I	C - W - -	DPT_Start	0/1	[Ox] Timer	0=Switch Off; 1=Switch On
10, 21, 32, 43	1 Bit	I	C - W - -	DPT_Start	0/1	[Ox] Flashing	0=Stop; 1=Start
11, 22, 33, 44	1 Bit	I	C - W - -	DPT_Alarm	0/1	[Ox] Alarm	0=Normal; 1=Alarm
	1 Bit	I	C - W - -	DPT_Alarm	0/1	[Ox] Alarm	0=Alarm; 1=Normal
12, 23, 34, 45	1 Bit	I	C - W - -	DPT_Ack	0/1	[Ox] Unfreeze Alarm	Alarm=0 + Unfreeze=1 => End Alarm
13, 24, 35, 46	1 Bit	O	C R - T -	DPT_State	0/1	[Ox] Warning Time (Status)	0=Normal; 1=Warning
14, 25, 36, 47	4 Bytes	I/O	C R W T -	DPT_LongDeltaTimeSec	-2147483648 - 2147483647	[Ox] Operating Time (s)	Time in Seconds

15, 26, 37, 48	2 Bytes	I/O	C R W T -	DPT_TimePeriodHrs	0 - 65535	[Ox] Operating Time (h)	Time in Hours
181	1 Byte	I	C - W - -	DPT_SceneControl	0-63; 128-191	[Shutter] Scenes	0 - 63 (Execute 1 - 64); 128 - 191 (Save 1 - 64)
182, 211	1 Bit	I	C - W - -	DPT_UpDown	0/1	[Cx] Move	0 = Raise; 1 = Lower
183, 212	1 Bit	I	C - W - -	DPT_Step	0/1	[Cx] Stop/Step	0 = Stop/StepUp; 1 = Stop/StepDown
	1 Bit	I	C - W - -	DPT_Trigger	0/1	[Cx] Stop	0 = Stop; 1 = Stop
184, 213	1 Bit	I	C - W - -	DPT_Trigger	0/1	[Cx] Switched Control	0, 1 = Up, Down or Stop, Depending on the Last Move
185, 214	1 Bit	I	C - W - -	DPT_Enable	0/1	[Cx] Lock	0 = Unlock; 1 = Lock
186, 215	1 Byte	I	C - W - -	DPT_Scaling	0% - 100%	[Cx] Shutter Positioning	0% = Top; 100% = Bottom
187, 216	1 Byte	O	C R - T -	DPT_Scaling	0% - 100%	[Cx] Shutter Position (Status)	0% = Top; 100% = Bottom
188, 217	1 Byte	I	C - W - -	DPT_Scaling	0% - 100%	[Cx] Slats Positioning	0% = Open; 100% = Closed
189, 218	1 Byte	O	C R - T -	DPT_Scaling	0% - 100%	[Cx] Slats Position (Status)	0% = Open; 100% = Closed
190, 219	1 Bit	O	C R - T -	DPT_Switch	0/1	[Cx] Rising Relay (Status)	0 = Open; 1 = Closed
191, 220	1 Bit	O	C R - T -	DPT_Switch	0/1	[Cx] Lowering Relay (Status)	0 = Open; 1 = Closed
192, 221	1 Bit	O	C R - T -	DPT_Switch	0/1	[Cx] Movement (Status)	0 = Stopped; 1 = Moving
193, 222	1 Bit	O	C R - T -	DPT_UpDown	0/1	[Cx] Movement Direction (Status)	0 = Upward; 1 = Downward
194, 223	1 Bit	I	C - W - -	DPT_Switch	0/1	[Cx] Auto: On/Off	0 = On; 1 = Off
	1 Bit	I	C - W - -	DPT_Switch	0/1	[Cx] Auto: On/Off	0 = Off; 1 = On
195, 224	1 Bit	O	C R - T -	DPT_Switch	0/1	[Cx] Auto: On/Off (Status)	0 = On; 1 = Off
	1 Bit	O	C R - T -	DPT_Switch	0/1	[Cx] Auto: On/Off (Status)	0 = Off; 1 = On
196, 225	1 Bit	I	C - W - -	DPT_UpDown	0/1	[Cx] Auto: Move	0 = Raise; 1 = Lower
197, 226	1 Bit	I	C - W - -	DPT_Step	0/1	[Cx] Auto: Stop/Step	0 = Stop/StepUp; 1 = Stop/StepDown
	1 Bit	I	C - W - -	DPT_Step	0/1	[Cx] Auto: Stop	0 = Stop; 1 = Stop
198, 227	1 Byte	I	C - W - -	DPT_Scaling	0% - 100%	[Cx] Auto: Shutter Positioning	0% = Top; 100% = Bottom
199, 228	1 Byte	I	C - W - -	DPT_Scaling	0% - 100%	[Cx] Auto: Slats Positioning	0% = Open; 100% = Closed
200, 229	1 Bit	I	C - W T U	DPT_Scene_AB	0/1	[Cx] Sunshine/Shadow	0 = Sunshine; 1 = Shadow
	1 Bit	I	C - W T U	DPT_Scene_AB	0/1	[Cx] Sunshine/Shadow	0 = Shadow; 1 = Sunshine
201, 230	1 Bit	I	C - W T U	DPT_Heat_Cool	0/1	[Cx] Cooling/Heating	0 = Heating; 1 = Cooling
	1 Bit	I	C - W T U	DPT_Heat_Cool	0/1	[Cx] Cooling/Heating	0 = Cooling; 1 = Heating
202, 231	1 Bit	I	C - W T U	DPT_Occupancy	0/1	[Cx] Presence/No Presence	0 = Presence; 1 = No Presence
	1 Bit	I	C - W T U	DPT_Occupancy	0/1	[Cx] Presence/No Presence	0 = No Presence; 1 = Presence
203, 204, 232, 233	1 Bit	I	C - W - -	DPT_Alarm	0/1	[Cx] Alarm x	0 = No Alarm; 1 = Alarm
	1 Bit	I	C - W - -	DPT_Alarm	0/1	[Cx] Alarm x	0 = Alarm; 1 = No Alarm
205, 234	1 Bit	I	C - W - -	DPT_Ack	0/1	[Cx] Unfreeze Alarm	Alarm1 = Alarm2 = No Alarm + Unfreeze (1) => End Alarm

206, 235	1 Bit	I	C - W - -	DPT_Scene_AB	0/1	[Cx] Move (Reversed)	0=Lower; 1=Raise
207, 236	1 Bit	I	C - W - -	DPT_Ack	0/1	[Cx] Direct Positioning 1	0 = No Action; 1 = Go to Position
208, 237	1 Bit	I	C - W - -	DPT_Ack	0/1	[Cx] Direct Positioning 2	0 = No Action; 1 = Go to Position
209, 238	1 Bit	I	C - W - -	DPT_Ack	0/1	[Cx] Direct Positioning 1 (Save)	0 = No Action; 1 = Save Current Position
210, 239	1 Bit	I	C - W - -	DPT_Ack	0/1	[Cx] Direct Positioning 2 (Save)	0 = No Action; 1 = Save Current Position
414	1 Byte	I	C - W - U	DPT_SceneControl	0-63; 128-191	[Fan Coil] Scenes	0 - 63 (Execute 1 - 64); 128 - 191 (Save 1 - 64)
415	1 Bit	I	C - W - U	DPT_Switch	0/1	[FCx] On/Off	0 = Off; 1 = On
416	1 Bit	O	CR - T -	DPT_Switch	0/1	[FCx] On/Off (Status)	0 = Off; 1 = On
417	1 Bit	I	C - W - U	DPT_Heat_Cool	0/1	[FCx] Mode	0 = Cool; 1 = Heat
418	1 Bit	O	CR - T -	DPT_Heat_Cool	0/1	[FCx] Mode (Status)	0 = Cool; 1 = Heat
419	1 Bit	I	C - W - U	DPT_Enable	0/1	[FCx] Fan: Manual/Automatic	0 = Automatic; 1 = Manual
	1 Bit	I	C - W - U	DPT_Enable	0/1	[FCx] Fan: Manual/Automatic	0 = Manual; 1 = Automatic
420	1 Bit	O	CR - T -	DPT_Enable	0/1	[FCx] Fan: Manual/Automatic (Status)	0 = Automatic; 1 = Manual
	1 Bit	O	CR - T -	DPT_Enable	0/1	[FCx] Fan: Manual/Automatic (Status)	0 = Manual; 1 = Automatic
421	1 Bit	I	C - W - U	DPT_Step	0/1	[FCx] Manual Fan: Step Control	0 = Down; 1 = Up
422	1 Bit	I	C - W - U	DPT_Switch	0/1	[FCx] Manual Fan: Speed 0	0 = Off; 1 = On
423	1 Bit	I	C - W - U	DPT_Switch	0/1	[FCx] Manual Fan: Speed 1	0 = Off; 1 = On
424	1 Bit	I	C - W - U	DPT_Switch	0/1	[FCx] Manual Fan: Speed 2	0 = Off; 1 = On
425	1 Bit	I	C - W - U	DPT_Switch	0/1	[FCx] Manual Fan: Speed 3	0 = Off; 1 = On
426	1 Bit	O	CR - T -	DPT_Switch	0/1	[FCx] Fan: Speed 0 (Status)	0 = Off; 1 = On
427	1 Bit	O	CR - T -	DPT_Switch	0/1	[FCx] Fan: Speed 1 (Status)	0 = Off; 1 = On
428	1 Bit	O	CR - T -	DPT_Switch	0/1	[FCx] Fan: Speed 2 (Status)	0 = Off; 1 = On
429	1 Bit	O	CR - T -	DPT_Switch	0/1	[FCx] Fan: Speed 3 (Status)	0 = Off; 1 = On
430	1 Byte	I	C - W - U	DPT_Fan_Stage	0 - 255	[FCx] Manual Fan: Enumeration Control	S0 = 0; S1 = 1; S2 = 2; S3 = 3
	1 Byte	I	C - W - U	DPT_Fan_Stage	0 - 255	[FCx] Manual Fan: Enumeration Control	S0 = 0; S1 = 1; S2 = 2
	1 Byte	I	C - W - U	DPT_Fan_Stage	0 - 255	[FCx] Manual Fan: Enumeration Control	S0 = 0; S1 = 1
431	1 Byte	O	CR - T -	DPT_Fan_Stage	0 - 255	[FCx] Fan: Speed Enumeration (Status)	S0 = 0; S1 = 1; S2 = 2; S3 = 3
	1 Byte	O	CR - T -	DPT_Fan_Stage	0 - 255	[FCx] Fan: Speed Enumeration (Status)	S0 = 0; S1 = 1; S2 = 2

	1 Byte	O	CR-T-	DPT_Fan_Stage	0 - 255	[FCx] Fan: Speed Enumeration (Status)	S0 = 0; S1 = 1
432	1 Byte	I	C-W-U	DPT_Scaling	0% - 100%	[FCx] Manual Fan: Percentage Control	S0 = 0%; S1 = 0,4-33,3%; S2 = 33,7-66,7%; S3 = 67,1-100%
	1 Byte	I	C-W-U	DPT_Scaling	0% - 100%	[FCx] Manual Fan: Percentage Control	S0 = 0%; S1 = 1-50%; S2 = 51-100%
	1 Byte	I	C-W-U	DPT_Scaling	0% - 100%	[FCx] Manual Fan: Percentage Control	S0 = 0%; S1 = 1-100%
433	1 Byte	O	CR-T-	DPT_Scaling	0% - 100%	[FCx] Fan: Speed Percentage (Status)	S0 = 0%; S1 = 33,3%; S2 = 66,6%; S3 = 100%
	1 Byte	O	CR-T-	DPT_Scaling	0% - 100%	[FCx] Fan: Speed Percentage (Status)	S0 = 0%; S1 = 1-50%; S2 = 51-100%
	1 Byte	O	CR-T-	DPT_Scaling	0% - 100%	[FCx] Fan: Speed Percentage (Status)	S0 = 0%; S1 = 1-100%
434	1 Byte	I	C-W-U	DPT_Scaling	0% - 100%	[FCx] Cooling Fan: Continuous Control	0 - 100%
	1 Byte	I	C-W-U	DPT_Scaling	0% - 100%	[FCx] Cooling Valve: PI Control (Continuous)	0 - 100%
435	1 Byte	I	C-W-U	DPT_Scaling	0% - 100%	[FCx] Heating Fan: Continuous Control	0 - 100%
	1 Byte	I	C-W-U	DPT_Scaling	0% - 100%	[FCx] Heating Valve: PI Control (Continuous)	0 - 100%
436	1 Bit	I	C-W-U	DPT_OpenClose	0/1	[FCx] Cooling Valve: Control Variable (1 bit)	0 = Open Valve; 1 = Close Valve
	1 Bit	I	C-W-U	DPT_Switch	0/1	[FCx] Cooling Valve: Control Variable (1 bit)	0 = Close Valve; 1 = Open Valve
437	1 Bit	I	C-W-U	DPT_OpenClose	0/1	[FCx] Heating Valve: Control Variable (1 bit)	0 = Open Valve; 1 = Close Valve
	1 Bit	I	C-W-U	DPT_Switch	0/1	[FCx] Heating Valve: Control Variable (1 bit)	0 = Close Valve; 1 = Open Valve
438	1 Bit	O	CR-T-	DPT_OpenClose	0/1	[FCx] Cooling Valve (Status)	0 = Open; 1 = Closed
	1 Bit	O	CR-T-	DPT_Switch	0/1	[FCx] Cooling Valve (Status)	0 = Closed; 1 = Open
	1 Bit	O	CR-T-	DPT_OpenClose	0/1	[FCx] Valve (Status)	0 = Open; 1 = Closed
	1 Bit	O	CR-T-	DPT_Switch	0/1	[FCx] Valve (Status)	0 = Closed; 1 = Open
439	1 Bit	O	CR-T-	DPT_OpenClose	0/1	[FCx] Heating Valve (Status)	0 = Open; 1 = Closed
	1 Bit	O	CR-T-	DPT_Switch	0/1	[FCx] Heating Valve (Status)	0 = Closed; 1 = Open
440	1 Bit	O	CR-T-	DPT_Switch	0/1	[FCx] Cooling Valve: Anti-Seize Protection (Status)	0 = Not Active; 1 = Active
	1 Bit	O	CR-T-	DPT_Switch	0/1	[FCx] Valve: Anti-Seize Protection (Status)	0 = Not Active; 1 = Active

441	1 Bit	O	CR-T-	DPT_Switch	0/1	[FCx] Heating Valve: Anti-Seize Protection (Status)	0 = Not Active; 1 = Active
442	1 Byte	O	CR-T-	DPT_Scaling	0% - 100%	[FCx] Valve (Status)	0 - 100%
	1 Byte	O	CR-T-	DPT_Scaling	0% - 100%	[FCx] Cooling Valve (Status)	0 - 100%
443	1 Byte	O	CR-T-	DPT_Scaling	0% - 100%	[FCx] Heating Valve (Status)	0 - 100%
444	1 Bit	O	CR-T-	DPT_Boo1	0/1	[FCx] Control Value - Error	0 = No Error; 1 = Error
445	2 Bytes	I	C-W-U	DPT_Value_Temp	-273.00° - 670433.28°	[FCx] Ambient Temperature	Ambient Temperature
446	2 Bytes	I	C-W-U	DPT_Value_Temp	-273.00° - 670433.28°	[FCx] Setpoint Temperature	Setpoint Temperature
447	2 Bytes	I/O	CRWTU	DPT_TimePeriodMin	0 - 65535	[FCx] Duration of Manual Control	0 = Endless; 1 - 1440 min
	2 Bytes	I/O	CRWTU	DPT_TimePeriodHrs	0 - 65535	[FCx] Duration of Manual Control	0 = Endless; 1 - 24 h
513, 519, 525, 531, 537, 543	1 Bit	I	C-W--	DPT_Enable	0/1	[Ix] Input Lock	0 = Unlock; 1 = Lock
514, 520, 526, 532, 538, 544	1 Bit		C--T-	DPT_Switch	0/1	[Ix] [Short Press] 0	Sending of 0
	1 Bit		C--T-	DPT_Switch	0/1	[Ix] [Short Press] 1	Sending of 1
	1 Bit	I	C-WT-	DPT_Switch	0/1	[Ix] [Short Press] 0/1 Switching	Switching 0/1
	1 Bit		C--T-	DPT_UpDown	0/1	[Ix] [Short Press] Move Up Shutter	Sending of 0 (Up)
	1 Bit		C--T-	DPT_UpDown	0/1	[Ix] [Short Press] Move Down Shutter	Sending of 1 (Down)
	1 Bit		C--T-	DPT_UpDown	0/1	[Ix] [Short Press] Move Up/Down Shutter	Switching 0/1 (Up/Down)
	1 Bit		C--T-	DPT_Step	0/1	[Ix] [Short Press] Stop/Step Up Shutter	Sending of 0 (Stop/Step Up)
	1 Bit		C--T-	DPT_Step	0/1	[Ix] [Short Press] Stop/Step Down Shutter	Sending of 1 (Stop/Step Down)
	1 Bit		C--T-	DPT_Step	0/1	[Ix] [Short Press] Stop/Step Shutter (Switched)	Switching of 0/1 (Stop/Step Up/Down)
	4 Bit		C--T-	DPT_Control_Dimming	0x0 (Stop) 0x1 (Dec. by 100%) ... 0x7 (Dec. by 1%) 0x8 (Stop) 0xD (Inc. by 100%) ... 0xF (Inc. by 1%)	[Ix] [Short Press] Brighter	Increase Brightness
4 Bit		C--T-	DPT_Control_Dimming	0x0 (Stop) 0x1 (Dec. by 100%) ... 0x7 (Dec. by 1%) 0x8 (Stop) 0xD (Inc. by 100%)	[Ix] [Short Press] Darker	Decrease Brightness	

				0xF (Inc. by 1%)			
	4 Bit		C--T-	DPT_Control_Dimming	0x0 (Stop) 0x1 (Dec. by 100%) ... 0x7 (Dec. by 1%) 0x8 (Stop) 0xD (Inc. by 100%) ... 0xF (Inc. by 1%)	[Ix] [Short Press] Brighter/Darker	Switch Bright/Dark
	1 Bit		C--T-	DPT_Switch	0/1	[Ix] [Short Press] Light On	Sending of 1 (On)
	1 Bit		C--T-	DPT_Switch	0/1	[Ix] [Short Press] Light Off	Sending of 0 (Off)
	1 Bit	I	C-WT-	DPT_Switch	0/1	[Ix] [Short Press] Light On/Off	Switching 0/1
	1 Byte		C--T-	DPT_SceneControl	0-63; 128-191	[Ix] [Short Press] Run Scene	Sending of 0 - 63
	1 Byte		C--T-	DPT_SceneControl	0-63; 128-191	[Ix] [Short Press] Save Scene	Sending of 128 - 191
	1 Bit	I/O	CRWT-	DPT_Switch	0/1	[Ix] [Switch/Sensor] Edge	Sending of 0 or 1
	1 Byte		C--T-	DPT_Value_1_Ucount	0 - 255	[Ix] [Short Press] Constant Value (Integer)	0 - 255
	1 Byte		C--T-	DPT_Scaling	0% - 100%	[Ix] [Short Press] Constant Value (Percentage)	0% - 100%
	2 Bytes		C--T-	DPT_Value_2_Ucount	0 - 65535	[Ix] [Short Press] Constant Value (Integer)	0 - 65535
	2 Bytes		C--T-	9.xxx	-671088.64 - 670433.28	[Ix] [Short Press] Constant Value (Float)	Float Value
515, 521, 527, 533, 539, 545	1 Byte	I	C-W--	DPT_Scaling	0% - 100%	[Ix] [Short Press] Shutter Status (Input)	0% = Top; 100% = Bottom
	1 Byte	I	C-W--	DPT_Scaling	0% - 100%	[Ix] [Short Press] Dimming Status (Input)	0% - 100%
516, 522, 528, 534, 540, 546	1 Bit		C--T-	DPT_Switch	0/1	[Ix] [Long Press] 0	Sending of 0
	1 Bit		C--T-	DPT_Switch	0/1	[Ix] [Long Press] 1	Sending of 1
	1 Bit	I	C-WT-	DPT_Switch	0/1	[Ix] [Long Press] 0/1 Switching	Switching 0/1
	1 Bit		C--T-	DPT_UpDown	0/1	[Ix] [Long Press] Move Up Shutter	Sending of 0 (Up)
	1 Bit		C--T-	DPT_UpDown	0/1	[Ix] [Long Press] Move Down Shutter	Sending of 1 (Down)
	1 Bit		C--T-	DPT_UpDown	0/1	[Ix] [Long Press] Move Up/Down Shutter	Switching 0/1 (Up/Down)
	1 Bit		C--T-	DPT_Step	0/1	[Ix] [Long Press] Stop/Step Up Shutter	Sending of 0 (Stop/Step Up)
	1 Bit		C--T-	DPT_Step	0/1	[Ix] [Long Press] Stop/Step Down Shutter	Sending of 1 (Stop/Step Down)

	1 Bit		C - - T -	DPT_Step	0/1	[Ix] [Long Press] Stop/Step Shutter (Switched)	Switching of 0/1 (Stop/Step Up/Down)
	4 Bit		C - - T -	DPT_Control_Dimming	0x0 (Stop) 0x1 (Dec. by 100%) ... 0x7 (Dec. by 1%) 0x8 (Stop) 0xD (Inc. by 100%) ... 0xF (Inc. by 1%)	[Ix] [Long Press] Brighter	Long Pr. -> Brighter; Release -> Stop
	4 Bit		C - - T -	DPT_Control_Dimming	0x0 (Stop) 0x1 (Dec. by 100%) ... 0x7 (Dec. by 1%) 0x8 (Stop) 0xD (Inc. by 100%) ... 0xF (Inc. by 1%)	[Ix] [Long Press] Darker	Long Pr. -> Darker; Release -> Stop
	4 Bit		C - - T -	DPT_Control_Dimming	0x0 (Stop) 0x1 (Dec. by 100%) ... 0x7 (Dec. by 1%) 0x8 (Stop) 0xD (Inc. by 100%) ... 0xF (Inc. by 1%)	[Ix] [Long Press] Brighter/Darker	Long Pr. -> Brighter/Darker; Release -> Stop
	1 Bit		C - - T -	DPT_Switch	0/1	[Ix] [Long Press] Light On	Sending of 1 (On)
	1 Bit		C - - T -	DPT_Switch	0/1	[Ix] [Long Press] Light Off	Sending of 0 (Off)
	1 Bit	I	C - W T -	DPT_Switch	0/1	[Ix] [Long Press] Light On/Off	Switching 0/1
	1 Byte		C - - T -	DPT_SceneControl	0-63; 128-191	[Ix] [Long Press] Run Scene	Sending of 0 - 63
	1 Byte		C - - T -	DPT_SceneControl	0-63; 128-191	[Ix] [Long Press] Save Scene	Sending of 128 - 191
	1 Bit	O	C R - T -	DPT_Alarm	0/1	[Ix] [Switch/Sensor] Alarm: Breakdown or Sabotage	1 = Alarm; 0 = No Alarm
	2 Bytes		C - - T -	9.xxx	-671088.64 - 670433.28	[Ix] [Long Press] Constant Value (Float)	Float Value
	2 Bytes		C - - T -	DPT_Value_2_Ucount	0 - 65535	[Ix] [Long Press] Constant Value (Integer)	0 - 65535
	1 Byte		C - - T -	DPT_Scaling	0% - 100%	[Ix] [Long Press] Constant Value (Percentage)	0% - 100%
	1 Byte		C - - T -	DPT_Value_1_Ucount	0 - 255	[Ix] [Long Press] Constant Value (Integer)	0 - 255
	517, 523, 529, 535, 541, 547	1 Bit		C - - T -	DPT_Trigger	0/1	[Ix] [Long Press/Release] Stop

						Shutter	
518, 524, 530, 536, 542, 548	1 Byte	I	C - W - -	DPT_Scaling	0% - 100%	[Ix] [Long Press] Dimming Status (Input)	0% - 100%
	1 Byte	I	C - W - -	DPT_Scaling	0% - 100%	[Ix] [Long Press] Shutter Status (Input)	0% = Top; 100% = Bottom
585	1 Byte	I	C - W - -	DPT_SceneNumber	0 - 63	[Motion Detector] Scene Input	Scene Value
586	1 Byte		C - - T -	DPT_SceneControl	0-63; 128-191	[Motion Detector] Scene Output	Scene Value
587, 616, 645, 674, 703, 732	1 Byte	O	CR - T -	DPT_Scaling	0% - 100%	[Ix] Luminosity	0-100%
588, 617, 646, 675, 704, 733	1 Bit	O	CR - T -	DPT_Alarm	0/1	[Ix] Open Circuit Error	0 = No Error; 1 = Open Circuit Error
589, 618, 647, 676, 705, 734	1 Bit	O	CR - T -	DPT_Alarm	0/1	[Ix] Short Circuit Error	0 = No Error; 1 = Short Circuit Error
590, 619, 648, 677, 706, 735	1 Byte	O	CR - T -	DPT_Scaling	0% - 100%	[Ix] Presence State (Scaling)	0-100%
591, 620, 649, 678, 707, 736	1 Byte	O	CR - T -	DPT_HVACMode	1=Comfort 2=Standby 3=Economy 4=Building Protection	[Ix] Presence State (HVAC)	Auto, Comfort, Standby, Economy, Building Protection
592, 621, 650, 679, 708, 737	1 Bit	O	CR - T -	DPT_Switch	0/1	[Ix] Presence State (Binary)	Binary Value
	1 Bit	O	CR - T -	DPT_Start	0/1	[Ix] Presence: Slave Output	1 = Motion Detected
593, 622, 651, 680, 709, 738	1 Bit	I	C - W - -	DPT_Window_Door	0/1	[Ix] Presence Trigger	Binary Value to Trigger the Presence Detection
594, 623, 652, 681, 710, 739	1 Bit	I	C - W - -	DPT_Start	0/1	[Ix] Presence: Slave Input	0 = Nothing; 1 = Detection from slave device
595, 624, 653, 682, 711, 740	2 Bytes	I	C - W - -	DPT_TimePeriodSec	0 - 65535	[Ix] Presence: Waiting Time	0-65535 s.
596, 625, 654, 683, 712, 741	2 Bytes	I	C - W - -	DPT_TimePeriodSec	0 - 65535	[Ix] Presence: Listening Time	1-65535 s.
597, 626, 655, 684, 713, 742	1 Bit	I	C - W - -	DPT_Enable	0/1	[Ix] Presence: Enable	According to parameters
598, 627, 656, 685, 714, 743	1 Bit	I	C - W - -	DPT_DayNight	0/1	[Ix] Presence: Day/Night	According to parameters
599, 628, 657, 686, 715, 744	1 Bit	O	CR - T -	DPT_Occupancy	0/1	[Ix] Presence: Occupancy State	0 = Not Occupied; 1 = Occupied
600, 629, 658, 687, 716, 745	1 Bit	I	C - W - -	DPT_Start	0/1	[Ix] External Motion Detection	0 = Nothing; 1 = Motion detected by an external sensor
601, 606, 611, 630, 635, 640, 659, 664, 669, 688, 693, 698, 717, 722, 727, 746, 751, 756	1 Byte	O	CR - T -	DPT_Scaling	0% - 100%	[Ix] [Cx] Detection State (Scaling)	0-100%
602, 607, 612, 631, 636, 641, 660, 665, 670, 689, 694, 699, 718, 723, 728, 747, 752, 757	1 Byte	O	CR - T -	DPT_HVACMode	1=Comfort 2=Standby 3=Economy 4=Building Protection	[Ix] [Cx] Detection State (HVAC)	Auto, Comfort, Standby, Economy, Building Protection
603, 608, 613, 632, 637, 642,	1 Bit	O	CR - T -	DPT_Switch	0/1	[Ix] [Cx] Detection State (Binary)	Binary Value

661, 666, 671, 690, 695, 700, 719, 724, 729, 748, 753, 758							
604, 609, 614, 633, 638, 643, 662, 667, 672, 691, 696, 701, 720, 725, 730, 749, 754, 759	1 Bit	I	C - W - -	DPT_Enable	0/1	[Ix] [Cx] Enable Channel	According to parameters
605, 610, 615, 634, 639, 644, 663, 668, 673, 692, 697, 702, 721, 726, 731, 750, 755, 760	1 Bit	I	C - W - -	DPT_Switch	0/1	[Ix] [Cx] Force State	0 = No Detection; 1 = Detection
935, 939, 943, 947, 951, 955	2 Bytes	O	CR - T -	DPT_Value_Temp	-273.00° - 670433.28°	[Ix] Current Temperature	Temperature Sensor Value
936, 940, 944, 948, 952, 956	1 Bit	O	CR - T -	DPT_Alarm	0/1	[Ix] Overcooling	0 = No Alarm; 1 = Alarm
937, 941, 945, 949, 953, 957	1 Bit	O	CR - T -	DPT_Alarm	0/1	[Ix] Overheating	0 = No Alarm; 1 = Alarm
938, 942, 946, 950, 954, 958	1 Bit	O	CR - T -	DPT_Alarm	0/1	[Ix] Probe Error	0 = No Alarm; 1 = Alarm
983, 984, 985, 986, 987, 988, 989, 990, 991, 992, 993, 994, 995, 996, 997, 998, 999, 1000, 1001, 1002, 1003, 1004, 1005, 1006, 1007, 1008, 1009, 1010, 1011, 1012, 1013, 1014, 1015, 1016, 1017, 1018, 1019, 1020, 1021, 1022, 1023, 1024, 1025, 1026, 1027, 1028, 1029, 1030, 1031, 1032, 1033, 1034, 1035, 1036, 1037, 1038, 1039, 1040, 1041, 1042, 1043, 1044, 1045, 1046	1 Bit	I	C - W - -	DPT_Bool	0/1	[LF] (1-Bit) Data Entry x	Binary Data Entry (0/1)
1047, 1048, 1049, 1050, 1051, 1052, 1053, 1054, 1055, 1056, 1057, 1058, 1059, 1060, 1061, 1062, 1063, 1064, 1065, 1066, 1067, 1068, 1069, 1070, 1071, 1072, 1073, 1074, 1075, 1076, 1077, 1078	1 Byte	I	C - W - -	DPT_Value_1_Ucount	0 - 255	[LF] (1-Byte) Data Entry x	1-Byte Data Entry (0-255)
1079, 1080, 1081, 1082, 1083, 1084, 1085, 1086, 1087, 1088, 1089, 1090, 1091, 1092, 1093, 1094, 1095, 1096, 1097, 1098, 1099, 1100, 1101, 1102, 1103, 1104, 1105, 1106, 1107, 1108, 1109, 1110	2 Bytes	I	C - W - -	DPT_Value_2_Ucount	0 - 65535	[LF] (2-Byte) Data Entry x	2-Byte Data Entry

1111, 1112, 1113, 1114, 1115, 1116, 1117, 1118, 1119, 1120, 1121, 1122, 1123, 1124, 1125, 1126	4 Bytes	I	C - W - -	DPT_Value_4_Count	-2147483648 - 2147483647	[LF] (4-Byte) Data Entry x	4-Byte Data Entry
1127, 1128, 1129, 1130, 1131, 1132, 1133, 1134, 1135, 1136, 1137, 1138, 1139, 1140, 1141, 1142, 1143, 1144, 1145, 1146	1 Bit	O	CR - T -	DPT_Bool	0/1	[LF] Function x - Result	(1-Bit) Boolean
	1 Byte	O	CR - T -	DPT_Value_1_Ucount	0 - 255	[LF] Function x - Result	(1-Byte) Unsigned
	2 Bytes	O	CR - T -	DPT_Value_2_Ucount	0 - 65535	[LF] Function x - Result	(2-Byte) Unsigned
	4 Bytes	O	CR - T -	DPT_Value_4_Count	-2147483648 - 2147483647	[LF] Function x - Result	(4-Byte) Signed
	1 Byte	O	CR - T -	DPT_Scaling	0% - 100%	[LF] Function x - Result	(1-Byte) Percentage
	2 Bytes	O	CR - T -	DPT_Value_2_Count	-32768 - 32767	[LF] Function x - Result	(2-Byte) Signed
	2 Bytes	O	CR - T -	9.xxx	-671088.64 - 670433.28	[LF] Function x - Result	(2-Byte) Float
1147, 1169	1 Bit	I	C - W - -	DPT_Trigger	0/1	[MLx] Trigger	Trigger the Master Light Function
1148, 1149, 1150, 1151, 1152, 1153, 1154, 1155, 1156, 1157, 1158, 1159, 1170, 1171, 1172, 1173, 1174, 1175, 1176, 1177, 1178, 1179, 1180, 1181	1 Bit	I	C - W - -	DPT_Switch	0/1	[MLx] Status Object x	Binary Status
1160, 1182	1 Bit	O	CR - T -	DPT_Switch	0/1	[MLx] General Status	Binary Status
1161, 1183	1 Bit		C - - T -	DPT_Switch	0/1	[MLx] General Switch Off: Binary Object	Switch Off Sending
1162, 1184	1 Byte		C - - T -	DPT_Scaling	0% - 100%	[MLx] General Switch Off: Scaling	0-100%
1163, 1185	1 Byte		C - - T -	DPT_SceneControl	0-63; 128-191	[MLx] General Switch Off: Scene	Scene Sending
1164, 1186	1 Byte		C - - T -	DPT_HVACMode	1=Comfort 2=Standby 3=Economy 4=Building Protection	[MLx] General Switch Off: HVAC mode	Auto, Comfort, Standby, Economy, Building Protection
1165, 1187	1 Bit		C - - T -	DPT_Switch	0/1	[MLx] Courtesy Switch On: Binary Object	Switch On Sending
1166, 1188	1 Byte		C - - T -	DPT_Scaling	0% - 100%	[MLx] Courtesy Switch On: Scaling	0-100%
1167, 1189	1 Byte		C - - T -	DPT_SceneControl	0-63; 128-191	[MLx] Courtesy Switch On: Scene	Scene Sending
1168, 1190	1 Byte		C - - T -	DPT_HVACMode	1=Comfort 2=Standby 3=Economy 4=Building Protection	[MLx] Courtesy Switch On: HVAC mode	Auto, Comfort, Standby, Economy, Building Protection
1191, 1259, 1327, 1395	1 Bit	I	C - W - -	DPT_Switch	0/1	[HTx] [A] On/Off	0 = Off; 1 = On
1192, 1260, 1328, 1396	1 Bit	O	CR - T -	DPT_Switch	0/1	[HTx] [A] On/Off Status	0 = Off; 1 = On

1193, 1261, 1329, 1397	1 Byte	I	C - W - -	DPT_SceneControl	0-63; 128-191	[HTx] [A] Scene Input	Scene Value
1194, 1262, 1330, 1398	2 Bytes	I	C - W T U	DPT_Value_Temp	-273.00° - 670433.28°	[HTx] [A] Temperature Source 1	External Sensor Temperature
1195, 1263, 1331, 1399	2 Bytes	I	C - W T U	DPT_Value_Temp	-273.00° - 670433.28°	[HTx] [A] Temperature Source 2	External Sensor Temperature
1196, 1264, 1332, 1400	2 Bytes	O	CR - T -	DPT_Value_Temp	-273.00° - 670433.28°	[HTx] [A] Room Temperature	Current Temperature
1197, 1265, 1333, 1401	1 Bit	I/O	CR W - -	DPT_Heat_Cool	0/1	[HTx] [A] System Mode	0 = Cooling; 1 = Heating
1198, 1266, 1334, 1402	1 Bit	I/O	CR W - -	DPT_Heat_Cool	0/1	[HTx] [A] User Mode	0 = Cooling; 1 = Heating
1199, 1267, 1335, 1403	1 Bit	I/O	CR W - -	DPT_Switch	0/1	[HTx] [A] Force System Mode	0 = User Mode / Auto Change; 1 = System Mode
1200, 1268, 1336, 1404	1 Bit	O	CR - T -	DPT_Heat_Cool	0/1	[HTx] [A] Mode Status	0 = Cooling; 1 = Heating
1201, 1269, 1337, 1405	1 Byte	I	C - W T U	DPT_Scaling	0% - 100%	[HTx] [A] Fan Speed	0% - 100%
1202, 1270, 1338, 1406	1 Bit	I	C - W T U	DPT_Enable	0/1	[HTx] [A] Fan: Manual/Automatic	0 = Manual; 1 = Automatic
	1 Bit	I	C - W T U	DPT_Enable	0/1	[HTx] [A] Fan: Manual/Automatic	0 = Automatic; 1 = Manual
1203, 1271, 1339, 1407	1 Bit	O	CR - T -	DPT_Switch	0/1	[HTx] [A] On/Off Fancoil	0 = Off; 1 = On
1204, 1272, 1340, 1408	1 Bit	I	C - W - -	DPT_Reset	0/1	[HTx] [B] User Comfort Setpoint Reset	0 = Nothing; 1 = Reset
1205, 1273, 1341, 1409	2 Bytes	I	C - W T U	DPT_Value_Temp	-273.00° - 670433.28°	[HTx] [B] User Setpoint Control	[-20°C, 100°C]
	2 Bytes	I	C - W T U	DPT_Value_Tempd	-671088.64° - 670433.28°	[HTx] [B] User Setpoint Offset	[-15°C, 15°C]
1206, 1274, 1342, 1410	1 Bit	I	C - W - -	DPT_Step	0/1	[HTx] [B] Step User Setpoint	0 = Decrease; 1 = Increase
1207, 1275, 1343, 1411	2 Bytes	I/O	CR W T U	DPT_Value_Temp	-273.00° - 670433.28°	[HTx] [B] Comfort Setpoint (Cooling)	[-20°C, 100°C]
	2 Bytes	I/O	CR W T U	DPT_Value_Temp	-273.00° - 670433.28°	[HTx] [B] Comfort Setpoint	[-20°C, 100°C]
1208, 1276, 1344, 1412	2 Bytes	I/O	CR W T U	DPT_Value_Temp	-273.00° - 670433.28°	[HTx] [B] Standby Setpoint (Cooling)	[-20°C, 100°C]
1209, 1277, 1345, 1413	2 Bytes	I/O	CR W T U	DPT_Value_Temp	-273.00° - 670433.28°	[HTx] [B] Economy Setpoint (Cooling)	[-20°C, 100°C]
1210, 1278, 1346, 1414	2 Bytes	I/O	CR W T U	DPT_Value_Temp	-273.00° - 670433.28°	[HTx] [B] Protection Setpoint (Cooling)	[-20°C, 100°C]
1211, 1279, 1347, 1415	2 Bytes	I/O	CR W T U	DPT_Value_Temp	-273.00° - 670433.28°	[HTx] [B] Comfort Setpoint (Heating)	[-20°C, 100°C]
1212, 1280, 1348, 1416	2 Bytes	I/O	CR W T U	DPT_Value_Temp	-273.00° - 670433.28°	[HTx] [B] Standby Setpoint (Heating)	[-20°C, 100°C]
1213, 1281, 1349, 1417	2 Bytes	I/O	CR W T U	DPT_Value_Temp	-273.00° - 670433.28°	[HTx] [B] Economy Setpoint (Heating)	[-20°C, 100°C]
1214, 1282, 1350, 1418	2 Bytes	I/O	CR W T U	DPT_Value_Temp	-273.00° - 670433.28°	[HTx] [B] Protection Setpoint (Heating)	[-20°C, 100°C]
1215, 1283, 1351, 1419	2 Bytes	O	CR - T -	DPT_Value_Temp	-273.00° - 670433.28°	[HTx] [B] Real Setpoint Status	[-20°C, 100°C]
1216, 1284, 1352, 1420	2 Bytes	O	CR - T -	DPT_Value_Temp	-273.00° - 670433.28°	[HTx] [B] User Setpoint Status	[-20°C, 100°C]
	2 Bytes	O	CR - T -	DPT_Value_Tempd	-671088.64° - 670433.28°	[HTx] [B] User Setpoint Offset Status	[-15°C, 15°C]

1217, 1285, 1353, 1421	2 Bytes	I/O	CRWTU	DPT_TimePeriodSec	0 - 65535	[HTx] [C] Transition Time: Comfort to Default Mode	Seconds (0 = Disabled)
	2 Bytes	I/O	CRWTU	DPT_TimePeriodMin	0 - 65535	[HTx] [C] Transition Time: Comfort to Default Mode	Minutes (0 = Disabled)
	2 Bytes	I/O	CRWTU	DPT_TimePeriodHrs	0 - 65535	[HTx] [C] Transition Time: Comfort to Default Mode	Hours (0 = Disabled)
1218, 1286, 1354, 1422	2 Bytes	I/O	CRWTU	DPT_TimePeriodSec	0 - 65535	[HTx] [C] Transition Time: Standby to Economy	Seconds (0 = Disabled)
	2 Bytes	I/O	CRWTU	DPT_TimePeriodMin	0 - 65535	[HTx] [C] Transition Time: Standby to Economy	Minutes (0 = Disabled)
	2 Bytes	I/O	CRWTU	DPT_TimePeriodHrs	0 - 65535	[HTx] [C] Transition Time: Standby to Economy	Hours (0 = Disabled)
1219, 1287, 1355, 1423	2 Bytes	I/O	CRWTU	DPT_TimePeriodSec	0 - 65535	[HTx] [C] Comfort Setpoint Reset Time	Seconds (0 = Disabled)
	2 Bytes	I/O	CRWTU	DPT_TimePeriodMin	0 - 65535	[HTx] [C] Comfort Setpoint Reset Time	Minutes (0 = Disabled)
	2 Bytes	I/O	CRWTU	DPT_TimePeriodHrs	0 - 65535	[HTx] [C] Comfort Setpoint Reset Time	Hours (0 = Disabled)
1220, 1288, 1356, 1424	1 Bit	I/O	CRW--	DPT_Occupancy	0/1	[HTx] [C] Presence Detector (Input)	0 = Not Occupied; 1 = Occupied
1221, 1289, 1357, 1425	1 Bit	I/O	CRW--	DPT_Enable	0/1	[HTx] [C] Lock Presence Detection	0 = Unlocked; 1 = Locked
	1 Bit	I/O	CRW--	DPT_Enable	0/1	[HTx] [C] Lock Presence Detection	0 = Locked; 1 = Unlocked
1222, 1290, 1358, 1426	1 Bit	I/O	CRW--	DPT_Bool	0/1	[HTx] [C] Sold/Unsold Room (Input)	0 = Unsold; 1 = Sold
1223, 1291, 1359, 1427	1 Byte	I	C-W--	DPT_HVACMode	1=Comfort 2=Standby 3=Economy 4=Building Protection	[HTx] [D] Special Mode	1-byte HVAC Mode
1224, 1292, 1360, 1428	1 Bit	I	C-W--	DPT_Ack	0/1	[HTx] [D] Special Mode: Comfort	0 = Nothing; 1 = Trigger
	1 Bit	I	C-W--	DPT_Switch	0/1	[HTx] [D] Special Mode: Comfort	0 = Off; 1 = On
1225, 1293, 1361, 1429	1 Bit	I	C-W--	DPT_Ack	0/1	[HTx] [D] Special Mode: Standby	0 = Nothing; 1 = Trigger
	1 Bit	I	C-W--	DPT_Switch	0/1	[HTx] [D] Special Mode: Standby	0 = Off; 1 = On
1226, 1294, 1362, 1430	1 Bit	I	C-W--	DPT_Ack	0/1	[HTx] [D] Special Mode: Economy	0 = Nothing; 1 = Trigger
	1 Bit	I	C-W--	DPT_Switch	0/1	[HTx] [D] Special Mode: Economy	0 = Off; 1 = On
1227, 1295, 1363, 1431	1 Bit	I	C-W--	DPT_Ack	0/1	[HTx] [D] Special Mode: Protection	0 = Nothing; 1 = Trigger
	1 Bit	I	C-W--	DPT_Switch	0/1	[HTx] [D] Special Mode: Protection	0 = Off; 1 = On
1228, 1296, 1364, 1432	1 Byte	O	CR-T-	DPT_HVACMode	1=Comfort	[HTx] [D] Special Mode Status	1-byte HVAC Mode

					2=Standby 3=Economy 4=Building Protection		
1229, 1297, 1365, 1433	1 Bit	O	CR-T-	DPT_Switch	0/1	[HTx] [D] Comfort Mode Status	0 = Off; 1 = On
1230, 1298, 1366, 1434	1 Bit	I	C-W--	DPT_Window_Door	0/1	[HTx] [D] Window Status 1 (Input)	0 = Closed; 1 = Open
	1 Bit	I	C-W--	DPT_Window_Door	0/1	[HTx] [D] Window Status 1 (Input)	0 = Open; 1 = Closed
1231, 1299, 1367, 1435	1 Bit	I	C-W--	DPT_Window_Door	0/1	[HTx] [D] Window Status 2 (Input)	0 = Closed; 1 = Open
	1 Bit	I	C-W--	DPT_Window_Door	0/1	[HTx] [D] Window Status 2 (Input)	0 = Open; 1 = Closed
1232, 1300, 1368, 1436	1 Bit	I	C-W--	DPT_Window_Door	0/1	[HTx] [D] Window Status 3 (Input)	0 = Closed; 1 = Open
	1 Bit	I	C-W--	DPT_Window_Door	0/1	[HTx] [D] Window Status 3 (Input)	0 = Open; 1 = Closed
1233, 1301, 1369, 1437	1 Bit	I	C-W--	DPT_Window_Door	0/1	[HTx] [D] Window Status 4 (Input)	0 = Closed; 1 = Open
	1 Bit	I	C-W--	DPT_Window_Door	0/1	[HTx] [D] Window Status 4 (Input)	0 = Open; 1 = Closed
1234, 1302, 1370, 1438	1 Bit	I/O	CRW--	DPT_Enable	0/1	[HTx] [D] Enable Window Status	0 = Disabled; 1 = Enabled
1235, 1303, 1371, 1439	1 Bit	I/O	CRW--	DPT_Enable	0/1	[HTx] [D] Thermostat Lock	0 = Locked; 1 = Unlocked
	1 Bit	I/O	CRW--	DPT_Enable	0/1	[HTx] [D] Thermostat Lock	0 = Unlocked; 1 = Locked
1236, 1304, 1372, 1440	2 Bytes	I/O	CRWTU	DPT_Value_Temp	-273.00° - 670433.28°	[HTx] [D] Comfort Lower Limit	[-20°C, 100°C]
1237, 1305, 1373, 1441	2 Bytes	I/O	CRWTU	DPT_Value_Temp	-273.00° - 670433.28°	[HTx] [D] Comfort Upper Limit	[-20°C, 100°C]
1238, 1306, 1374, 1442	1 Bit	I/O	CRW--	DPT_Switch	0/1	[HTx] [D] Hidden Offset On/Off	0 = Off; 1 = On
1239, 1307, 1375, 1443	2 Bytes	I/O	CRWTU	DPT_Value_Tempd	-671088.64° - 670433.28°	[HTx] [D] Hidden Offset Value	[-20°C, 100°C]
1240, 1308, 1376, 1444	1 Bit	O	CR-T-	DPT_Bool	0/1	[HTx] [D] Eco Mode Notification	0 = Out of eco range; 1 = Setpoint in Eco Range
1241, 1309, 1377, 1445	1 Byte	O	CR-T-	DPT_Scaling	0% - 100%	[HTx] [D] Eco Mode Ratio	Percentage of Time Working in Eco Range
1242, 1310, 1378, 1446	2 Bytes	I/O	CRWTU	DPT_Value_Temp	-273.00° - 670433.28°	[HTx] [D] Eco Mode: Lower Limit (Cooling)	Lower Value for the Ecological Range
1243, 1311, 1379, 1447	2 Bytes	I/O	CRWTU	DPT_Value_Temp	-273.00° - 670433.28°	[HTx] [D] Eco Mode: Upper Limit (Heating)	Upper Value for the Ecological Range
1244, 1312, 1380, 1448	2 Bytes	O	CR-T-	DPT_Value_Temp	-273.00° - 670433.28°	[HTx] [D] Setpoint to Split	[-20°C, 100°C]
1245, 1313, 1381, 1449	2 Bytes	I	C-W--	DPT_Value_Humidity	-12% - 12%	[HTx] [F] Current Humidity	Humidity Sensor Value
1246, 1314, 1382, 1450	2 Bytes	I/O	CRWTU	DPT_Value_Humidity	-12% - 12%	[HTx] [F] High Humidity Alarm Threshold	Value of High Humidity Alarm Threshold

1247, 1315, 1383, 1451	1 Bit	I/O	CRWTU	DPT_Enable	0/1	[HTx] [F] Dehumidification Control	0 = Disabled; 1 = Enabled
1248, 1316, 1384, 1452	1 Bit	O	CR-T-	DPT_Bool	0/1	[HTx] [F] Dehumidification Status	0 = No Dehumidifying; 1 = Dehumidifying
1249, 1317, 1385, 1453	1 Bit	O	CR-T-	DPT_Alarm	0/1	[HTx] [F] High Humidity	0 = No Alarm; 1 = Alarm
1250, 1318, 1386, 1454	1 Bit	I/O	CRWTU	DPT_Enable	0/1	[HTx] [F] Enable Apparent Temperature	0 = Room Temperature; 1 = Apparent Temperature
1251, 1319, 1387, 1455	1 Byte	O	CR-T-	DPT_Scaling	0% - 100%	[HTx] [Cooling] Control Variable	PI Control (Continuous)
1252, 1320, 1388, 1456	1 Byte	O	CR-T-	DPT_Scaling	0% - 100%	[HTx] [Heating] Control Variable	PI Control (Continuous)
1253, 1321, 1389, 1457	1 Bit	O	CR-T-	DPT_Switch	0/1	[HTx] [Cooling] Control Variable	2-Point Control
	1 Bit	O	CR-T-	DPT_Switch	0/1	[HTx] [Cooling] Control Variable	PI Control (PWM)
1254, 1322, 1390, 1458	1 Bit	O	CR-T-	DPT_Switch	0/1	[HTx] [Heating] Control Variable	2-Point Control
	1 Bit	O	CR-T-	DPT_Switch	0/1	[HTx] [Heating] Control Variable	PI Control (PWM)
1255, 1323, 1391, 1459	1 Bit	O	CR-T-	DPT_Switch	0/1	[HTx] [Cooling] Additional Cool	Temp >= (Setpoint+Band) => "1"
1256, 1324, 1392, 1460	1 Bit	O	CR-T-	DPT_Switch	0/1	[HTx] [Heating] Additional Heat	Temp <= (Setpoint-Band) => "1"
1257, 1325, 1393, 1461	1 Bit	O	CR-T-	DPT_Switch	0/1	[HTx] [Cooling] PI State	0 = PI Signal 0%; 1 = PI Signal Greater than 0%
1258, 1326, 1394, 1462	1 Bit	O	CR-T-	DPT_Switch	0/1	[HTx] [Heating] PI State	0 = PI Signal 0%; 1 = PI Signal Greater than 0%
1463	1 Byte	I	C-W--	DPT_SceneControl	0-63; 128-191	[Thermostat] Scene Input	Scene Value
1464, 1502, 1540, 1578	2 Bytes	I	C-WTU	DPT_Value_Temp	-273.00° - 670433.28°	[Tx] Temperature Source 1	External Sensor Temperature
1465, 1503, 1541, 1579	2 Bytes	I	C-WTU	DPT_Value_Temp	-273.00° - 670433.28°	[Tx] Temperature Source 2	External Sensor Temperature
1466, 1504, 1542, 1580	2 Bytes	O	CR-T-	DPT_Value_Temp	-273.00° - 670433.28°	[Tx] Effective Temperature	Effective Control Temperature
1467, 1505, 1543, 1581	1 Byte	I	C-W--	DPT_HVACMode	1=Comfort 2=Standby 3=Economy 4=Building Protection	[Tx] Special Mode	1-Byte HVAC Mode
1468, 1506, 1544, 1582	1 Bit	I	C-W--	DPT_Ack	0/1	[Tx] Special Mode: Comfort	0 = Nothing; 1 = Trigger
	1 Bit	I	C-W--	DPT_Switch	0/1	[Tx] Special Mode: Comfort	0 = Off; 1 = On
1469, 1507, 1545, 1583	1 Bit	I	C-W--	DPT_Ack	0/1	[Tx] Special Mode: Standby	0 = Nothing; 1 = Trigger
	1 Bit	I	C-W--	DPT_Switch	0/1	[Tx] Special Mode: Standby	0 = Off; 1 = On
1470, 1508, 1546, 1584	1 Bit	I	C-W--	DPT_Ack	0/1	[Tx] Special Mode: Economy	0 = Nothing; 1 = Trigger
	1 Bit	I	C-W--	DPT_Switch	0/1	[Tx] Special Mode: Economy	0 = Off; 1 = On
1471, 1509, 1547, 1585	1 Bit	I	C-W--	DPT_Ack	0/1	[Tx] Special Mode: Protection	0 = Nothing; 1 = Trigger
	1 Bit	I	C-W--	DPT_Switch	0/1	[Tx] Special Mode: Protection	0 = Off; 1 = On
1472, 1510, 1548, 1586	1 Bit	I	C-W--	DPT_Window_Door	0/1	[Tx] Window Status (Input)	0 = Closed; 1 = Open
1473, 1511, 1549, 1587	1 Bit	I	C-W--	DPT_Trigger	0/1	[Tx] Comfort Prolongation	0 = Nothing; 1 = Timed Comfort
1474, 1512, 1550, 1588	1 Byte	O	CR-T-	DPT_HVACMode	1=Comfort	[Tx] Special Mode Status	1-Byte HVAC Mode

					2=Standby 3=Economy 4=Building Protection		
1475, 1513, 1551, 1589	2 Bytes	I	C - W - -	DPT_Value_Temp	-273.00° - 670433.28°	[Tx] Setpoint	Thermostat Setpoint Input
	2 Bytes	I	C - W - -	DPT_Value_Temp	-273.00° - 670433.28°	[Tx] Basic Setpoint	Reference Setpoint
1476, 1514, 1552, 1590	1 Bit	I	C - W - -	DPT_Step	0/1	[Tx] Setpoint Step	0 = Decrease Setpoint; 1 = Increase Setpoint
1477, 1515, 1553, 1591	2 Bytes	I	C - W - -	DPT_Value_Tempd	-671088.64° - 670433.28°	[Tx] Setpoint Offset	Float Offset Value
1478, 1516, 1554, 1592	2 Bytes	O	CR - T -	DPT_Value_Temp	-273.00° - 670433.28°	[Tx] Setpoint Status	Current Setpoint
1479, 1517, 1555, 1593	2 Bytes	O	CR - T -	DPT_Value_Temp	-273.00° - 670433.28°	[Tx] Basic Setpoint Status	Current Basic Setpoint
1480, 1518, 1556, 1594	2 Bytes	O	CR - T -	DPT_Value_Tempd	-671088.64° - 670433.28°	[Tx] Setpoint Offset Status	Current Setpoint Offset
1481, 1519, 1557, 1595	1 Bit	I	C - W - -	DPT_Reset	0/1	[Tx] Setpoint Reset	Reset Setpoint to Default
	1 Bit	I	C - W - -	DPT_Reset	0/1	[Tx] Offset Reset	Reset Offset
1482, 1520, 1558, 1596	1 Bit	I	C - W - -	DPT_Heat_Cool	0/1	[Tx] Mode	0 = Cool; 1 = Heat
1483, 1521, 1559, 1597	1 Bit	O	CR - T -	DPT_Heat_Cool	0/1	[Tx] Mode Status	0 = Cool; 1 = Heat
1484, 1522, 1560, 1598	1 Bit	I	C - W - -	DPT_Switch	0/1	[Tx] On/Off	0 = Off; 1 = On
1485, 1523, 1561, 1599	1 Bit	O	CR - T -	DPT_Switch	0/1	[Tx] On/Off Status	0 = Off; 1 = On
1486, 1524, 1562, 1600	1 Bit	I/O	CRW - -	DPT_Switch	0/1	[Tx] Main System (Cool)	0 = System 1; 1 = System 2
1487, 1525, 1563, 1601	1 Bit	I/O	CRW - -	DPT_Switch	0/1	[Tx] Main System (Heat)	0 = System 1; 1 = System 2
1488, 1526, 1564, 1602	1 Bit	I	C - W - -	DPT_Enable	0/1	[Tx] Enable/Disable Secondary System (Cool)	0 = Disable; 1 = Enable
1489, 1527, 1565, 1603	1 Bit	I	C - W - -	DPT_Enable	0/1	[Tx] Enable/Disable Secondary System (Heat)	0 = Disable; 1 = Enable
1490, 1496, 1528, 1534, 1566, 1572, 1604, 1610	1 Byte	O	CR - T -	DPT_Scaling	0% - 100%	[Tx] [Sx] Control Variable (Cool)	PI Control (Continuous)
1491, 1497, 1529, 1535, 1567, 1573, 1605, 1611	1 Byte	O	CR - T -	DPT_Scaling	0% - 100%	[Tx] [Sx] Control Variable (Heat)	PI Control (Continuous)
	1 Byte	O	CR - T -	DPT_Scaling	0% - 100%	[Tx] [Sx] Control Variable	PI Control (Continuous)
1492, 1498, 1530, 1536, 1568, 1574, 1606, 1612	1 Bit	O	CR - T -	DPT_Switch	0/1	[Tx] [Sx] Control Variable (Cool)	2-Point Control
	1 Bit	O	CR - T -	DPT_Switch	0/1	[Tx] [Sx] Control Variable (Cool)	PI Control (PWM)
1493, 1499, 1531, 1537, 1569, 1575, 1607, 1613	1 Bit	O	CR - T -	DPT_Switch	0/1	[Tx] [Sx] Control Variable (Heat)	2-Point Control
	1 Bit	O	CR - T -	DPT_Switch	0/1	[Tx] [Sx] Control Variable (Heat)	PI Control (PWM)
	1 Bit	O	CR - T -	DPT_Switch	0/1	[Tx] [Sx] Control Variable	2-Point Control
	1 Bit	O	CR - T -	DPT_Switch	0/1	[Tx] [Sx] Control Variable	PI Control (PWM)
1494, 1500, 1532, 1538, 1570, 1576, 1608, 1614	1 Bit	O	CR - T -	DPT_Switch	0/1	[Tx] [Sx] PI State (Cool)	0 = PI Signal 0%; 1 = PI Signal Greater than 0%
1495, 1501, 1533, 1539, 1571, 1577, 1609, 1615	1 Bit	O	CR - T -	DPT_Switch	0/1	[Tx] [Sx] PI State (Heat)	0 = PI Signal 0%; 1 = PI Signal Greater than 0%

	1 Bit	O	CR-T-	DPT_Switch	0/1	[Tx] [Sx] PI State	0 = PI Signal 0%; 1 = PI Signal Greater than 0%
1616	3 Bytes	O	CR-T-	DPT_Date	01/01/1990 - 31/12/2089	[NTP] Date	Current Date
1617	3 Bytes	O	CR-T-	DPT_TimeOfDay	00:00:00 - 23:59:59	[NTP] Time of Day	Current Time
1618	8 Bytes	O	CR-T-	DPT_DateTime		[NTP] Date and Time	Current Date and Time
1619	1 Bit	I	C-W--	DPT_Ack	0/1	[NTP] Sending Request	0 = No Action; 1 = Request Date and Time Sending



Join and send us your inquiries
about Zennio devices:

<https://support.zennio.com>

Zennio Avance y Tecnología S.L.

C/ Río Jarama, 132. Nave P-8.11
45007 Toledo, Spain.

Tel. +34 925 232 002.

www.zennio.com

info@zennio.com