



Z40

KNX Capacitive Touch Panel

ZVIZ40

Application Program Version: [2.5]
User Manual Version: [2.5]_a

www.zennio.com

CONTENTS

Contents	2
1 Introduction.....	4
1.1 Z40	4
1.2 Functionality	6
1.3 Installation	8
1.4 Start-Up and Power Loss.....	9
2 Update Objects after Reset	10
3 Configuration.....	11
3.1 Main Configuration.....	11
3.1.1 GENERAL	11
3.1.2 Translations.....	16
3.1.3 Backlight.....	18
3.1.4 Security	18
3.1.5 Internal Temperature Sensor.....	21
3.1.6 Screensaver	21
3.1.7 Ambient Luminosity Sensor	24
3.1.8 Touch Locking	24
3.1.9 Sounds.....	26
3.1.10 ADVANCED	28
3.2 MENU.....	35
3.2.1 Configuration	39
3.3 Page <i>n</i>	40
3.3.1 Configuration	40
3.3.2 Box <i>i</i>	44
3.3.3 Setpoint.....	81
3.3.4 Fan.....	81
3.4 Configuration Page	83
3.5 Inputs	86
3.5.1 Binary Input.....	86
3.5.2 Temperature Probe.....	86
3.5.3 Motion Detector	86
3.6 Thermostat	87

ANNEX I. Communication Objects..... 88

1 INTRODUCTION

1.1 Z40

Z40 is an easily and intuitively controllable high-performance **touch screens** from Zennio. The built-in features and functions make them the ideal solution for integral room control in hotels, offices or any other environments where controlling climate systems, lighting systems, shutters, scenes, etc. is required

The most outstanding features of Z40 are:

- **4.1 inch (4.1")** backlit **capacitive touch panel** with backlit 'Home' button incorporated, with screen resolution of 320 x 240 pixel.
- Multiple **direct-action functions**, fully customisable.
- Control distribution across up to **7 customisable pages + 1 configuration page**.
- Full **climate** management.
- Programmable **timers**.
- **Scene** control.
- **Alarm** control.
- **Screensaver** with customizable image.
- **Multi-Language**.
- 2 independent **thermostats**.
- Built-in **temperature** sensor.
- **Ambient luminosity sensor** for brightness automatic adjustment.
- **Proximity sensor** for quick start.
- **Buzzer** for an audible acknowledgement of user actions (with the possibility of disabling it either by parameter or by object).

- Possibility of **locking / unlocking the touch panel** through binary orders or scenes, and of setting a timed/automatic locking of the device (**cleaning function**).
- **Pop-ups** and **Welcome Back object** (binary or scene).
- **Celsius and Fahrenheit** temperature scales for the on-screen indicators, being possible to select them in parameters or through communication object.
- 4 customisable **analogue-digital inputs**.
- **Heartbeat** or periodic “still-alive” notification.
- **Elegant** design, available in various **colours**.

1.2 FUNCTIONALITY

Application program feature the following functions:

- **7 Pages**, with up to 6 Fully-Customisable Boxes each, all of them fully combinable and configurable by the integrator. These pages can be configured as normal or thermostat type pages.

Box	Funcionality	Page	
		Normal	Thermostat
Indicators	Binary (icon, text)		
	Enumerated (icon, text)		
	Unsigned integer (1 / 2bytes)		
	Signed integer (1 / 2 / 4bytes)	✓	✓
	Scaling (percentage)		
	Temperature		
	Float (2 / 4bytes)		
	Text (14bytes)		
1-button Control	Switch (pre-set value, switch)		
	Two objects (short press / long press)		
	Hold & Release		
	Scene (run / save)	✓	✓
	Constant (counter, scaling, float)		
	Enumeration		
	Room State		
2-button Control	Switch (icon, text).		
	Switch + Indicator (counter, scaling, temperature)		
	Two objects (short press / long press)		
	Constant (counter, scaling, float)		
	Enumeration	✓	✗
	Shutters		
	Light dimming		
	Multimedia		
	Room State		
Climate Specific Control	Temperature Setpoint	✓	✗
	Mode (cool/heat, extended)		

	Special modes		
	Fan		
Other Controls	RGB		
	RGBW	✓	✗
	Daily / Weekly Timer		
	Alarm		
	Page direct link	✓	✓
Boxes on thermostat pages	Setpoint control	✗	✓
	Fan control		

Table 1. Controls available in each type of page.

- **1 Configuration Page** (optional), which contains the brightness and sounds settings, the calibration of the built-in temperature probe, the programming button, Hour/Date settings and Reset configuration.

1.3 INSTALLATION

Figure 1 shows the connection outline of the device:

1. Touch panel.
2. Backlit 'Home' button.
3. Luminosity and Proximity Sensors.
4. Input connectors.
5. Programation Button.
6. Programation LED.
7. KNX connector.
8. Temperatura Probe.
9. Fixing clip.

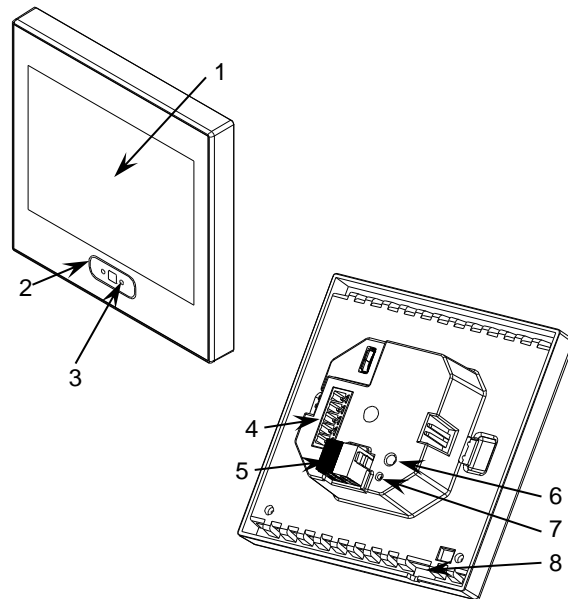

Figure 1. Schematic diagram.

Z40 is connected to the KNX bus through the built-in terminal (7). An external DC power supply is not needed.

A short press on the **Prog./Test button** (5) will make the device enter the programming mode. The **Prog./Test LED** (6) will then light in red. On the contrary, if this button is held while the device gets connected to the bus, Z40 will enter the **safe mode**. In such case, the programming LED will blink in red colour.

For detailed information about the technical features of Z40, as well as on security and installation procedures, please refer to the device **Datasheet**, bundled within the device packaging and also available at www.zennio.com.

1.4 START-UP AND POWER LOSS

After download or device reset it is necessary **to wait for about 2 minutes without performing any action** in order to make it possible a proper calibration of the proximity sensor and luminosity sensor.

It is recommended not to approach less than 50 cm from the device during this time and to avoid that the light strikes directly.

After download or power failure, the date and time flash to indicate that they may not be correct. The flashing stops when a value is received through the bus or it is set from the configuration page control.

2 UPDATE OBJECTS AFTER RESET

The aim of this functionality is allowing the integrator to make a read request to the statuses of the device objects after a reset. There are two situations in which this functionality may be useful:

- In case of a Z40 reset, if there have been changes in the bus while the Z40 was off, after the reset, the objects in Z40 keep the same value as before the reset, but not their actual value in the installation.
- In addition, after programming from ETS, all objects are initialized to their default values, but not to their actual values in the installation.

When a bus failure or ETS programming occurs, read requests of all the following objects will be sent gradually (to prevent bus overload):

- **General objects:** date and time, disabling pushbuttons, external temperature, and temperature scale.
- **Indicator objects.**
- **Timer** enabling objects.
- **Alarm confirmation** object.
- **Ventilation control:** Auto mode dedicated object. **RGB and RGBW** objects.

Objects that will NOT be updated are:

- **Control objects.**
- **Alarm trigger.**
- **4-Bit Light Dimming. Shutter: Stop/Step.**
- **All other objects**

The time and date objects of Z40 will be read from the bus always after a reset, regardless of whether this functionality is active or not.

3 CONFIGURATION

After importing the corresponding database in ETS and adding the device into the topology of the desired project, the configuration process begins by entering the Parameters tab of the device.

3.1 MAIN CONFIGURATION

This tab is divided into multiple screens, all of which contain a set of global parameters regarding the general functionality of the device, and therefore not specifically related to a particular page of the user interface.

3.1.1 GENERAL

The "General" tab contains general settings. Most are checkboxes for enabling/disabling other functionalities.

ETS PARAMETERISATION

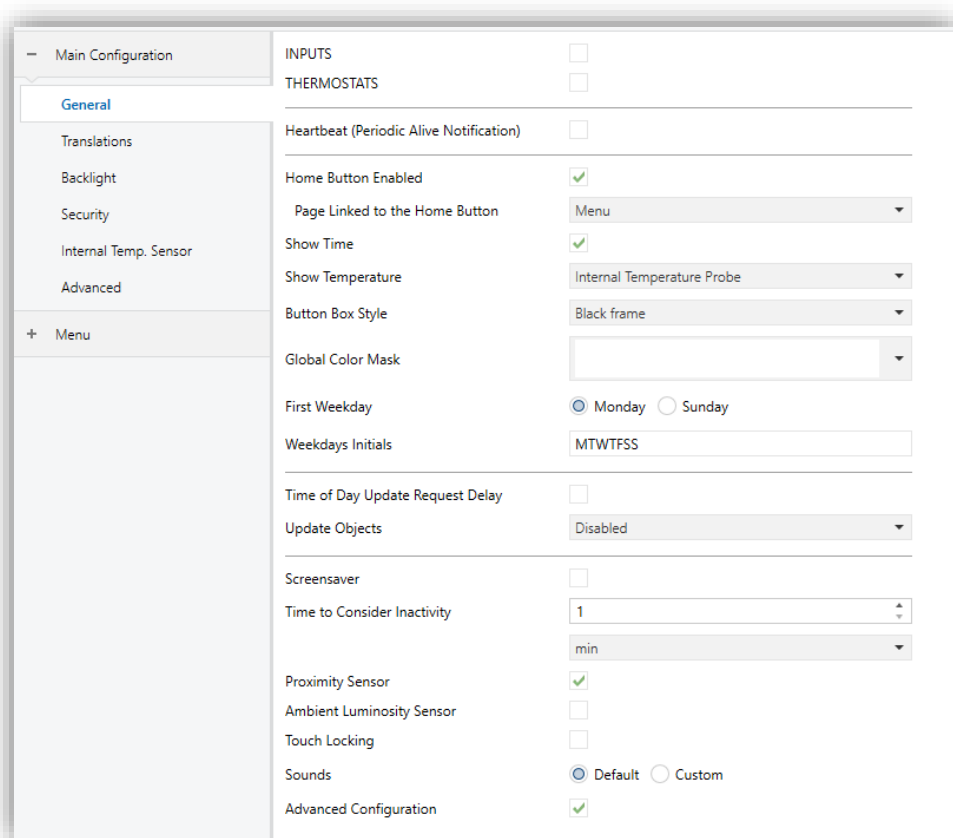

Figure 2. Main Configuration - General.

The following parameters are shown:

- **Inputs** [[disabled/enabled](#)]¹: enables or disables the “Inputs” tab in the tree on the left, depending on whether the device will or will not be connected any external accessories. For more information, see section 3.5.
- **Thermostats** [[disabled/enabled](#)]: enables or disables the “Thermostat” tab in the tree on the left. For more information, see section 3.6.
- **Heartbeat (Periodic Alive Notification)** [[disabled/enabled](#)]: incorporates a one-bit object to the project (“**[Heartbeat] Object to Send ‘1’**”) that will be sent periodically with value “1” to notify that the device is still working (*still alive*).

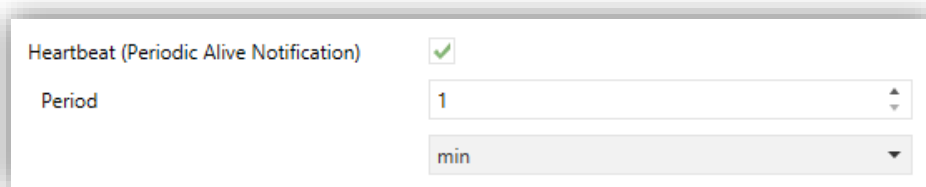

Figure 3. Heartbeat.

Note: *the first sending after download or bus failure takes place with a delay of up to 255 seconds, to prevent bus overload. The following sendings march the period set.*

- **Home Button Enabled** [[disabled/enabled](#)]: enables or disables the home button to access to the menu page. If enabled, the following parameter appears:
 - **Page Linked to the Home Button:** [[Menu / Page 1 / ... / Page 7 / Configuration Page](#)]: sets a shortcut to the indicated page when pressing on the Home Button.
- **Show Time** [[disabled/enabled](#)]: permits setting whether the current time (according to the internal clock) is displayed in the upper-left corner of any page or not.
- **Show Temperature** [[No / Internal Temperature Probe / External Value](#)]: sets whether the current temperature should show or not in the upper right corner of every page, being necessary in such case to choose the source of the

¹ The default values of each parameter will be highlighted in blue in this document, as follows: [[default/rest of options](#)].

temperature value: “Internal temperature probe” or “External value”. If the latter is chosen, an object named “[**General**] **External temperature**” will be enabled, so that it can be grouped with any other object that sends temperature values.

- **Button Box Style** [No frame / Colored frame / Black frame]: permits selecting a frame for the buttons of controls and pages, in order to distinguish them from the indicators.



Figure 4. Button box (black, white color, no box).

- **Global Color Mask** [White / Color select by dropdown]: permits selecting the color that will be applied to all the elements of the screen in a general way.

Note: *It is possible to set a different color in the desired boxes and buttons by using a specific parameter in their configuration tab (see section 3.3.2).*

- **First Weekday** [Monday / Sunday]: sets the first day of week on calendar.
- **Weekdays initials** [MTWTFSS]: permits customising the label that will represent each of the weekdays on the screen. A seven-character string (including letters or numbers), ordered according to the above First Weekday parameter, must be entered – each of the characters will represent one weekday.
- **Hour Update Request Delay** [disabled/enabled]: sets a sending **delay** [1...65535] [s/min/h] for the date/time request when the device starts up.
- **Update Objects** [Disabled / After Programming / After Reset / After Programming and Reset]: enables the sending of read requests to update status objects and indicators (see section 2 for further details). There are four options available, some of them with a configurable **delay**:
 - [Disabled]: no read request, therefore objects are not updated.
 - [After Programming]: read requests are sent after a complete or partial download (or when pressing the reset button in the configuration page, if set as “Parameters Reset”, see section 3.4), after the parameterised **delay** ([0...10...65535] [s/min/h]).

- [After Reset]: read request are sent when a reset occurs (bus failure, the Reset Device ETS option or when pressing the reset button in the configuration page, if set as “Z40 Reboot”, see section 3.4), after the parameterised **delay** ([0...10...65535] [s/min/h]).
- [After Programming and Reset]: combination of the two above options.
- **Screensaver** [disabled/enabled]: enables or disables the “Screensaver” tab in the tree on the left. See section 3.1.6 for details.
- **Time to Consider Inactivity** [1...65535] [s/min/h]: time that must elapse since the last press and/or proximity detection to consider inactivity state. Then the display backlight will dim. See section 3.1.3.
- **Proximity Sensor** [disabled/enabled]: enables the proximity sensor. This functionality permits “waking up” the device display when detecting presence through the proximity sensor

Please refer to the user manual “**Proximity and Luminosity Sensor**” (available in the Z40 product section at the Zennio homepage, www.zennio.com) for detailed information about the functionality and the configuration of the related parameters.

- **Ambient Luminosity Sensor** [disabled/enabled]: enables or disables the ambient luminosity sensor. When enabled, a new tab is added in the tree on the left (see section 3.1.7).
- **Touch Locking** [disabled/enabled]: enables or disables the possibility of locking the touch by object. When enabled, a new tab is added in the tree on the left (see section 3.1.8).
- **Sounds** [Default/Custom]: sets whether the sound functions (button beeps, alarm and doorbell) should work according to the pre-defined configuration (“Default”) or to a user-defined configuration (“Custom”) (see section 3.1.9).
- **Advanced Configuration** [enabled/disabled]: enables or disables the “Advanced” tab in the tree on the left (see section 3.1.10).

The project topology shows the following objects by default:

- “[**General**] **Time of Day**” : 3-byte object for setting the internal time of the device, for example, by linking it to a KNX clock. This object also allows read requests, so the current time of the device can be checked. It is also automatically sent after time changes made by the user from the screen itself.

Note: *although the DPT of this object considers a field for setting the day of the week, Z40 calculates it from the date and therefore ignores that field.*

Important: *Z40 does not have an RTC clock or battery to keep track of the time in the absence of power. Therefore, it is important to **receive the time periodically** from a device that obtains it through NTP and/or has a battery to prevent delays during bus failures.*

- “[**General**] **Date**” : 3-byte object for setting the internal date of the device, for example, by linking it to a KNX clock. This object also allows read requests, so the current date of the device can be checked. It is also automatically sent after date changes made by the user from the screen itself.
- “[**General**] **Scene: Receive**” and “[**General**] **Scene: Send**” : objects for respectively receiving and sending scene values from/to the KNX bus whenever it is necessary (e.g., when the user touches a button that has been configured to send scene commands; see section 3.3.2.2.4).
- “[**General**] **Activity**” : 1-bit object to force activity/inactivity state on the device. For further information, please refer to the user manual “**Proximity and Luminosity Sensor**” and “**Brightness**” (available in the Z40 product section at the Zennio homepage, www.zennio.com).
- “[**General**] **Display – Brightness**” : 1-byte percentage object for changing the display brightness level.
- “[**General**] **Proximity Sensor**”, “[**General**] **External Proximity Detection**” and “[**General**] **Proximity Detection**” : 1-bit object whose functionality is tied to the proximity sensor. For further information, please refer to the user manual “**Proximity and Luminosity Sensor**” (available in the Flat Display product section at the Zennio homepage, www.zennio.com).

- “[**General**] **Translations - Select Language**”: 1 and 2-byte objects for changing the language showed in the screen when receiving a value through the bus (see section 3.1.2).
- “[**General**] **Translations - Main Language**”: 1-bit object that, after the reception of the value “1” from the bus, will load the main language (see section 3.1.2).
- “[**General**] **Temperature Scale**”: 1-bit object which permits changing in runtime the scale of the temperatures that may show on the screen (see section 3.1.10).
- “[**Internal Temp. Probe**] **Current Temperature**”: 2-byte object through which the value of the current measurement of the built-in sensor will be sent to the bus, according to the parameterisation (see section 3.1.5).

3.1.2 TRANSLATIONS

Texts shown on the screen can be translated into up to **five different languages**.

Texts of page titles, box titles, indicators, etc. are entered by parameter in the corresponding configuration tab. For each language enabled, an additional textbox is displayed to enter the translation.

Note: *depending on the space occupied by the characters on the screen, the full text entered may not be displayed.*

Switching from language to another can be done through two types of communication objects:

- **Up to five 1-bit objects**, one for each language. If this is enabled, when a “1” is received through any of this, the corresponding language is activated in the device.
- **A 1-byte scene object**. The expected values in this object are fixed, from 0 to 4, to select the language. If the value received does not correspond to any language, the texts will be displayed in the main language.
- **A 2-byte ASCII object**. The expected values for this object are two characters of the ASCII code, corresponding to ISO 639-1. If the received character pair does not correspond to any enabled language but is in range, the texts will be represented in the main language, if an out-of-range value is received, it does not change the active language.

Notes:

- *Not case sensitive.*
- *Please refer to http://en.wikipedia.org/wiki/List_of_ISO_639-1_codes for a table with the language codes.*

On the other hand, Z40 allows the use of Latin, Greek and Cyrillic characters for the texts displayed on the screen.

ETS PARAMETERISATION

Figure 5. Main Configuration - Translations.

- **Main language** [*enabled*]: read-only parameter to make it evident that the main language is always enabled.
 - **Select language**: list of the available languages.
- **Language X** [*disabled/enabled*]: enables the additional language X.
 - **Select language**: list of available languages to select the language X.

Only the Main language is enabled by default.

While Translations stays enabled, the following objects are visible:

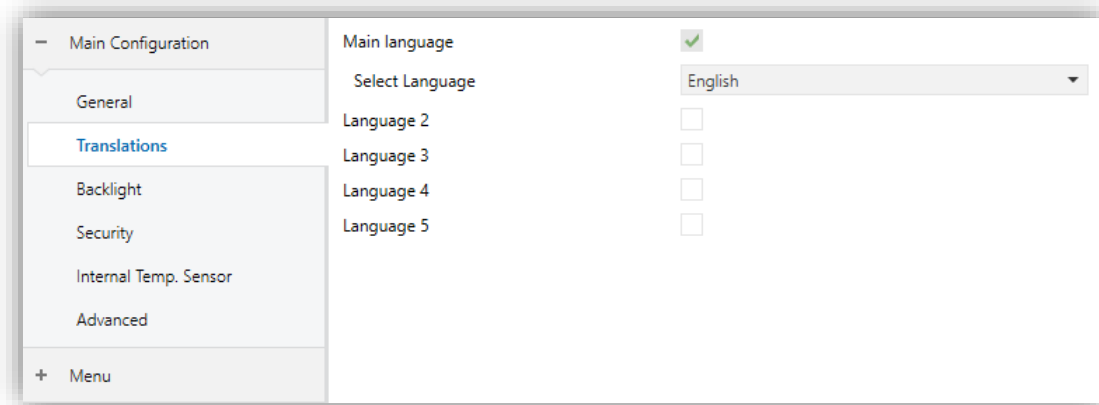
- “[General] Translations – Select language” (one-byte).
- “[General] Translations – Main language” (one-bit).
- “[General] Translations – Select language” (two-byte).

Up to four specific objects for the additional languages will be also shown, if required:

- “[General] Translations – Language X” (one bit).

These objects work accordingly to the behaviour mentioned above.

3.1.3 BACKLIGHT

Z40 allows managing the brightness of the display according to two operating modes: normal mode and night mode.

Note: Contrast is not a configurable feature in the device.

Please refer to the specific manual “**Brightness**” (available in the Z40 product section at the Zennio website, www.zennio.com) for detailed information about the functionality and the configuration of the related parameters.

3.1.4 SECURITY

Any box (general purpose) or page will be given the possibility of **restricted access by password**. Setting one or two different passwords is possible, so the integrator can afterwards configure whether the access to a page or box will be protected by one password or another, or remain unprotected – every page can be independently configured.

Buttons that lead to a protected page or box will show a little **lock** icon overlaid on their lower left corner.

Figure 6 shows the “enter password” dialog shown to the user when trying to access a protected page.



Figure 6. Security Pop up.

In case of setting up **two levels**, the first one is assumed to be *enclosed* by the second one. This means that whenever the device asks the user to type password #1 (to enter a certain page); password #2 will also be accepted. On the contrary, password #1 cannot be used instead of password #2. This behaviour permits, therefore, making password #2

available to users with further privileges while password #1 is assigned to users with fewer privileges.

Moreover, when accessing to a protected page, all the boxes and pages with the same or lower access level of the introduced password, are automatically unlocked. It can be set if the elements are relocked after a time period or a page switch.

ETS PARAMETERISATION

This screen permits selecting how many security levels (one or two) will be available for the configuration of the access to the control pages or the boxes.

Figure 7. Main Configuration - Security.

- **Security Levels** [[One Level](#) / [Two Levels](#)]: selects whether one or two security levels will be available.

Note: *with independence of the option selected here, it will be necessary to establish the security level desired for each specific page of controls.*

- **Protect Again** [[After a Time Period](#) / [After a Page Switch](#) / [After a Time Period or a Page Switch](#)]: sets when is re-activated the security of pages or boxes

unlocked. When selecting the first or the last option, a new parameter **Time** [10...65535][s] [1...65535][min/h] appears to set the time period.

- **Password** [Level 1: [1234](#); Level 2: [5678](#)]: parameter made of four additional textboxes, each of which should contain one of the four consecutive digits [0...9] that will compose the password.

In case of enabling two security levels, the Password parameter will show twice, being the first one referred to the password of Level 1, and the second one to the password of Level 2.

LEVEL 1 PASSWORD	
- Default Password (1)	1
- Default Password (2)	2
- Default Password (3)	3
- Default Password (4)	4
LEVEL 2 PASSWORD	
- Default Password (1)	5
- Default Password (2)	6
- Default Password (3)	7
- Default Password (4)	8

Figure 8. Two security levels.

Important: the password insertion dialog features a specific option (lower left button) that lets the user change, in runtime, the passwords originally set by parameter. After accessing this option and prior to typing the new password, the user will be required to type the corresponding old password (level 1 or level 2). Note that although it will be possible to type password 2 even if the device asks for password 1, the new password typed afterwards will be anyway stored as the new password for level 1.

- **Security Pad Labels:** parameter consisting in six additional textboxes, intended for the customisation of the messages that the device shows (or may show) when the user interacts with the password insertion dialog.
 - **Label for 'Enter Password 1'** [[Enter Password 1](#)]: message shown when the user is required to type in the password for level 1.
 - **Label for 'Enter Password 2'** [[Enter Password 2](#)]: message shown when the user is required to type in the password for level 2.

- **Label for ‘ERROR’** [[ERROR](#)]: message shown to the user when the typed password is not valid.
- **Label for ‘New Password’** [[New Password](#)]: message shown to ask the user for a new password, during the password change process.
- **Label for ‘Repeat Password’** [[Repeat Password](#)]: message shown when the user is required to re-type the new password.
- **Label for ‘Updated’** [[Updated](#)]: message shown to the user as a confirmation of the password change.

3.1.5 INTERNAL TEMPERATURE SENSOR

Z40 is equipped with **an internal temperature sensor** for monitoring the ambient temperature of the room, so that the device can report it to the KNX bus and trigger several actions when the temperature reaches certain values.

Please refer to the specific documentation of the **“Temperature Probe”** available at the Zennio homepage, www.zennio.com, for detailed information about the functionality and the configuration of the related parameters.

3.1.6 SCREENSAVER

The screensaver is a special page that will only be shown after a **period of inactivity**, configurable by parameter.

Configuring the screensaver to only show the current **Time**, the current **Temperature** (selecting the desired measurement source: the internal temperature sensor or an external value) or **both**.



Figure 9. Screensaver Pop up.

There will also be an option to show an **image** on the screensaver. This image will be loaded from a tab called DCA that will appear at the bottom of ETS (see section 3.1.6.1). In addition, in order to minimize download time, downloading or not the image with each programming can be chosen.

If the image and another screensaver option are enabled, both pages will alternate, each of them being active during 15 seconds.

The screensaver will disappear when touching the screen screen or the HOME button or, if the proximity sensor is activated, when it detects presence.

Notes:

- If a Pop-Up is being displayed (see section 3.1.10.2), screensaver will not become active.
- If a pop-up is activated when the screensaver is active (see touch locking 3.1.8, cleaning function 3.1.10.1 or Pop-Ups 3.1.10.2) this pop-up will become show up over screensaver.

ETS PARAMETERISATION

After enabling “**Screensaver**” from “General” screen (see section 3.1.1), a new tab will be incorporated into the tree on the left.

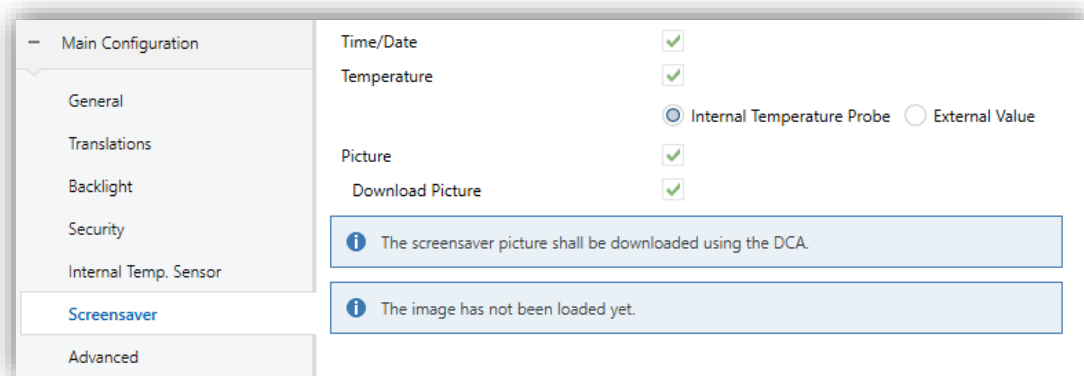

Figure 10. Main Configuration - Screensaver.

- **Time/Date** [*disabled/enabled*]: sets whether to show the current time or not.
- **Temperature** [*disabled/enabled*]: sets whether to show the current temperature or not. When enabled, it is possible to select the source of the temperature value [*Internal Temperature Probe / External Value*]. The latter option will enable a new two-byte object “[**General**] **External Temperature**” through which the device can receive the required values from the bus.

- **Picture** [[disabled/enabled](#)]: sets whether to show an image in the screensaver. This image will be selected using the ETS App Axx Image Downloader (ver section 3.1.6.1).
 - **Download Picture** [[disabled/enable](#)]: sets if the selected picture is updated with each download.

3.1.6.1 ZXX IMAGE DOWNLOADER

The ETS App Zxx Image Downloader offers the possibility to select a custom image to be used as a screensaver in Z40. When installed, an additional tab called **DCA** will be available.

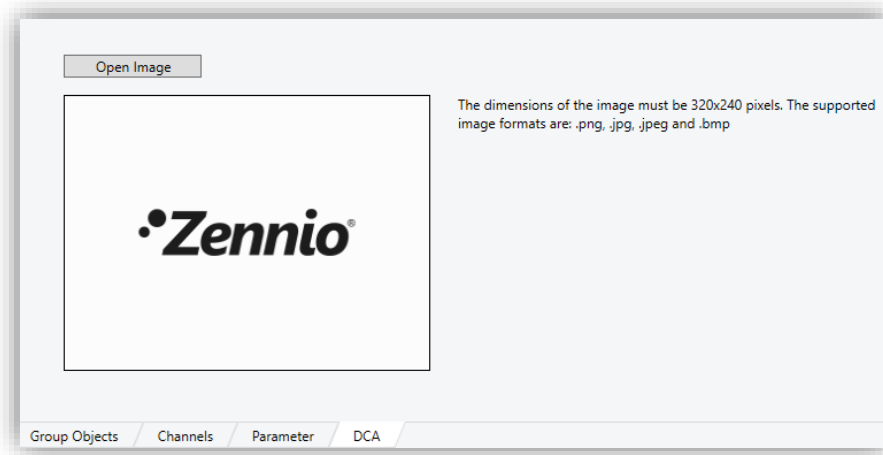

Figure 11. Zxx Image Downloader tab.

The dimensions of the image must be **320x240 pixels**, being the supported formats: **.png, .jpg, .jpeg** and **.bmp**.

When the chosen image met these conditions, a preview of it will be showed as well as a message indicating that the image has been loaded correctly.

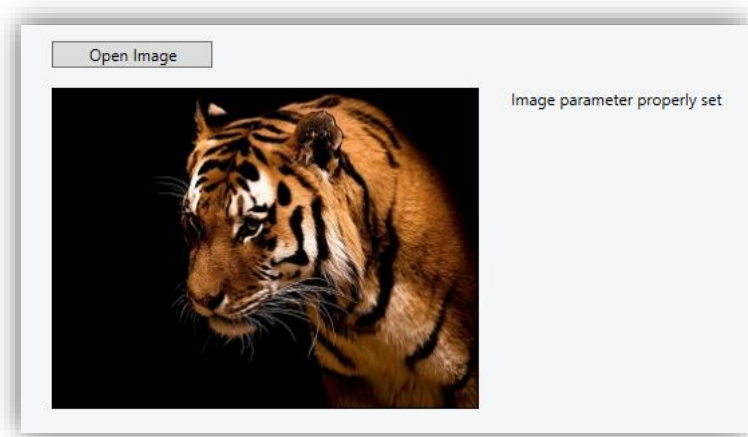

Figure 12. Preview of a correct image in the DCA.

After a valid image has been loaded, it will be downloaded when programming from ETS.

3.1.7 AMBIENT LUMINOSITY SENSOR

Z40 includes a sensor to measure the ambient luminosity level, so that the brightness of the display can be adjusted according to the current luminosity of the room.

Please refer to the specific manual “**Luminosity and Proximity Sensor**” (available in the Z40 product section at the Zennio homepage, www.zennio.com) for detailed information about the functionality and the configuration of the related parameters.

3.1.8 TOUCH LOCKING

The touch panel of Z40 can be optionally locked and unlocked anytime by writing a configurable one-bit value to a specific object provided for this purpose. It can also be done through scene values.

While locked, user presses on the touch buttons will be ignored: no actions will be performed when the user presses on any of the controls. However, if configured, a message will be shown on the display for three seconds if the user touches a button during the lock state.



Figure 13. Touch Locking message.

Note: If an alarm with active lock is activated, it will be disabled and you can press the screen normally. After confirming the alarm, the screen will be locked again.

ETS PARAMETERISATION

After enabling **Touch Locking** from “General” screen (see section 3.1.1), a new tab will be incorporated into the tree on the left.

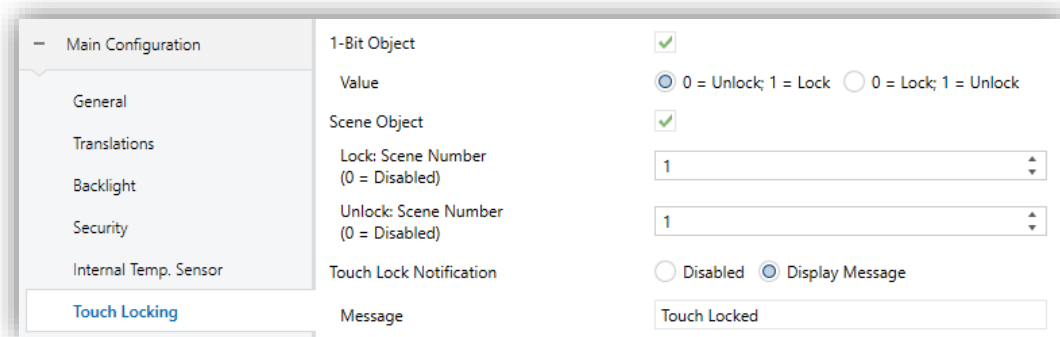

Figure 14. Main Configuration - Touch Locking.

In this tab you can configure the blocking of the presses on the display.

- **1-Bit Object** [*disabled/enabled*]: enables the 1-bit object “[General] Touch Locking” to trigger the touch lock.
- **Value** [*0 = Unlock; 1 = Lock / 0 = Lock; 1 = Unlock*]: parameter to select which value should trigger which action when received through the indicated object.

- **Scene Object** [*disabled/enabled*]: enables the touch locking and unlocking when receiving the configured scene value through the object (“**[General] Scene: receive**”).
 - **Lock: Scene Number (0 = Disabled)** [*0/1...64*]: scene number that locks the touch.
 - **Unlock: Scene Number (0 = Disabled)** [*0/1...64*]: scene number that unlocks the touch.
- **Touch Lock Notification** [*Disabled / Display Message*]: sets whether to display a message on the screen or not when the device is locked and the user attempts to touch a button. When the first one is selected, one textbox (**Message**) appears to enter the desired message.

3.1.9 SOUNDS

Z40 emits **3 types of sounds**, depending on the action performed:

- **Press Confirmation:** short beep indicating that the user has pressed a button. This only applies to step controls, i.e., controls that walk through a certain range of values and that do not send a value after every touch, but only the final value after the last press. For this action, the user can choose between two different sounds.
- **Sending Confirmation:** a slightly longer and sharper beep than the previous one. It indicates the sending of an object to the bus as a result of a press.
- **Alarm:** sharp and longer beep than the previous one, high intensity, which is typically used as alarm or bell.

The range of sounds emitted when these actions are performing will be different depending on the sound type selected.

Enabling and disabling the button sounds can be done in parameters or through an object, being also possible to define in parameters whether the button sounds should be initially enabled or not.

Pressing and sending confirmation sounds can be silenced using one of the following methods:

- **Parameterisation after ETS download.**

- 1-bit communication object.
- Checkbox in "Configuration Page".

Note: Under no circumstances the alarm or the ring tone will be muted.

ETS PARAMETERISATION

After enabling the "Custom" configuration of **Sounds** from "General" screen (see section 3.1.1), a new tab will be incorporated into the tree on the left.

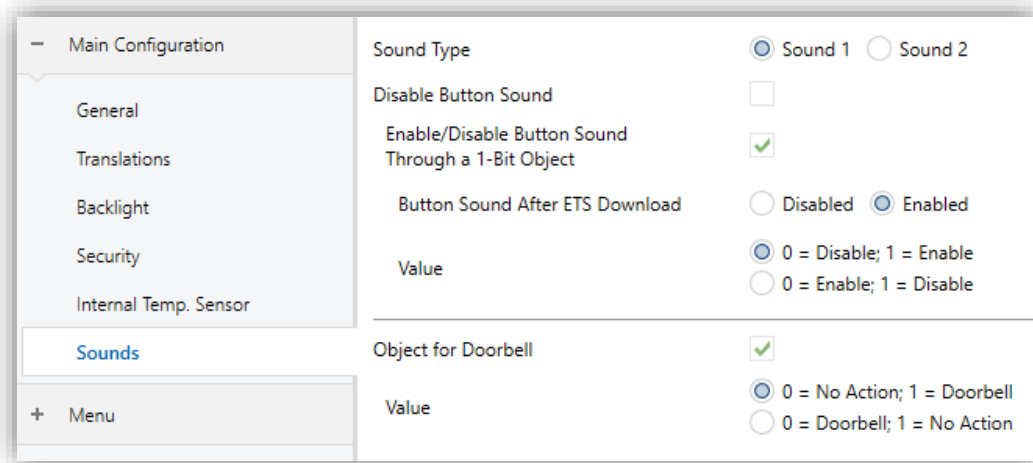

Figure 15. Main Configuration - Sounds.

The initial configuration of this screen is equivalent to the default option. However, the following parameters will be configurable.

- **Sound Type** [[Sound 1](#) / [Sound 2](#)]: sets which sounds range incorporates the device.
- **Disable Button Sounds** [[disabled/enabled](#)]: allows the user to ignore the push and to confirm sounds.
 - **Enable/Disable Button Sound Through a 1-bit Object** [[disabled/enabled](#)]: makes it possible to disable / resume the button beeping function in runtime by writing to a specific object ("[General] Sounds – Disabling button sound").
 - **Button Sound After ETS Download** [[Disabled](#) / [Enabled](#)]: sets whether the button beeping function should start up enabled (default option) or disabled after an ETS download.

- **Value** [0 = Disabled; 1 = Enabled / 0 = Enabled; 1 = Disabled]: parameter to select which value should trigger which action when received through the indicated object.
- **Object for Doorbell** [disabled/enabled]: enables or disables the doorbell function. If enabled, a specific object (“**[General] Sounds: Doorbell**”) will be included into the project topology.
 - **Value** [0 = No Action; 1 = Doorbell / 0 = Doorbell; 1 = No Action]: parameter to select which value should trigger which action when received through the indicated object

3.1.10 ADVANCED

Tab for the parameterisation of some advanced functions is shown in ETS if enabled from the “Configuration” tab. These functions are explained next.

ETS PARAMETERISATION

After enabling the **Advanced configuration** from “General” screen (see section 3.1.1), a new tab will be incorporated into the tree on the left.

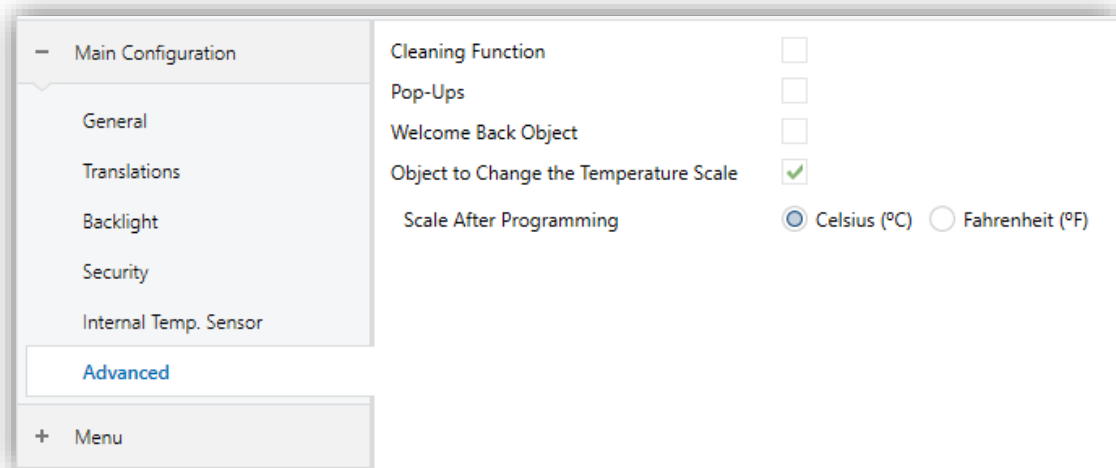

Figure 16. Main Configuration - Advanced.

- **Cleaning Function** [disabled/enabled]: enables or disables the “Cleaning Function” tab. See section 3.1.10.1 for details.
- **Pop-Ups** [disabled/enabled]: enables or disables the “Pop-Ups” tab. See section 3.1.10.2 for details.

- **Welcome Back Object** [[disabled/enabled](#)]: enables or disables the “Welcome Back Object” tab. See section 3.1.10.3 for details.
- **Object to Change the Temperature Scale** [[disabled/enabled](#)]: enables or disables the 1-bit object “[**General**] **Temperature Scale**”), which permits changing in runtime the scale of the temperatures that may show on the screen. By receiving one ‘0’ through this object, the scale will switch to Celsius, while after receiving one ‘1’ it will switch to Fahrenheit.

The selected scale applies to any temperatures shown on the screen, such as:

- The **screensaver** temperatura.
- Indicators of **temperature controls** linked to a box in the display ([Climate] Temperature setpoint)
- **Temperature indicators** ([Climate] Temperature).
- Temperature shown on the thermostat page **setpoint**.

In this functionality, the following parameter will also appear:

- **Scale After Programming** [[Celsius \(°C\) / Fahrenheit \(°F\)](#)]: sets the scale in use after download.

3.1.10.1 CLEANING FUNCTION

This feature is very similar to the touch locking, that is, it locks the touch area, thus discarding further button touches. The difference is that this function remains active only during a parameterisable time, and then stops.

This function is intended to let the user clean the touch area with the certainty of not triggering unwanted actions.

A message can be shown during the cleaning state. When the timeout is about to end, it is also possible to make this message blink or to make the device beep (or both).



Figure 17. Cleaning Function Pop up.

ETS PARAMETERISATION

After enabling **Cleaning Function** from “Advanced” screen (see section 3.1.10), a new tab will be incorporated into the tree on the left.

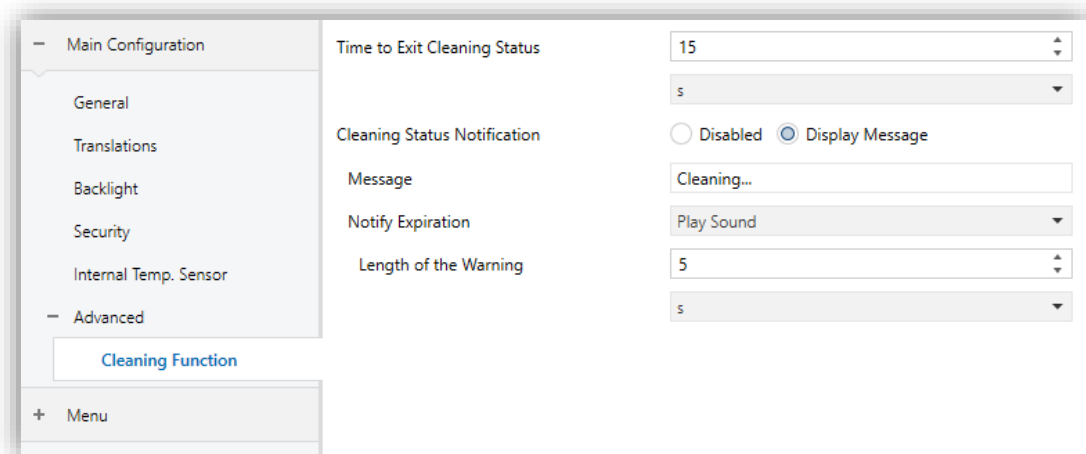

Figure 18. Advanced - Cleaning Function.

- **Time to Exit Cleaning Status** $[[5...15...65535][s] / [1...65535][min/h]]$: timeout to deactivate the cleaning function once triggered.
- **Cleaning Status Notification** $[Disabled / Display Message]$: sets whether to show a message during the cleaning state. When “Display Message” is selected, the following parameters appear:
 - **Message** $[Cleaning...]$: textbox to enter the desired message.
 - **Notify Expiration** $[No / Blink Message / Play Sound / Both]$: sets whether to notify the timeout expiration or not. When any of the three later options is selected, a new parameter shows up:

- **Length of the Warning** `[1...5...65535][s]` `[1...65535][min/h]`: sets the ahead-time to start the notification prior to the end of the cleaning function.

The “[**General**] **Cleaning Function**” one-bit object triggers the cleaning function when it receives a “1” from the KNX bus.

3.1.10.2 POP-UPS

This function is intended to show the user up to 6 different **Pop-Ups** of up to four lines of text on the display, each of which can be object-dependant or set in parameters.



Figure 19. Pop up.

Pop-ups can be shown/hidden through three types of communication objects:

- **1 Bit Object.** The display will show the pop-up when receiving a value of 1 bit and will be hidden when receiving the opposite value.
- **1 Byte Object.** The display will show the pop-up when receiving a value between 0 and 255 and will be hidden with another value between 0 and 255.
- **Changes in 14 bytes Objects** that define the text lines.

The Pop-Up displays a confirmation button to hide the Pop-Up with one click.

Note:

- *Pop-Ups take precedence over screensaver. When a Pop-Ups is displayed, the screensaver will be disabled until the first one disappears.*

- If, while a pop-up message is showing another one is enabled, the first one closes and only the last activated message will be shown.
- If the same value is set to show and to hide the message, only the order to show will be effective.

ETS PARAMETERISATION

After enabling **Pop-Ups** from “Advanced” screen (see section 3.1.10) a new tab will be incorporated into the tree on the left to enable up to 6 Pop-ups.

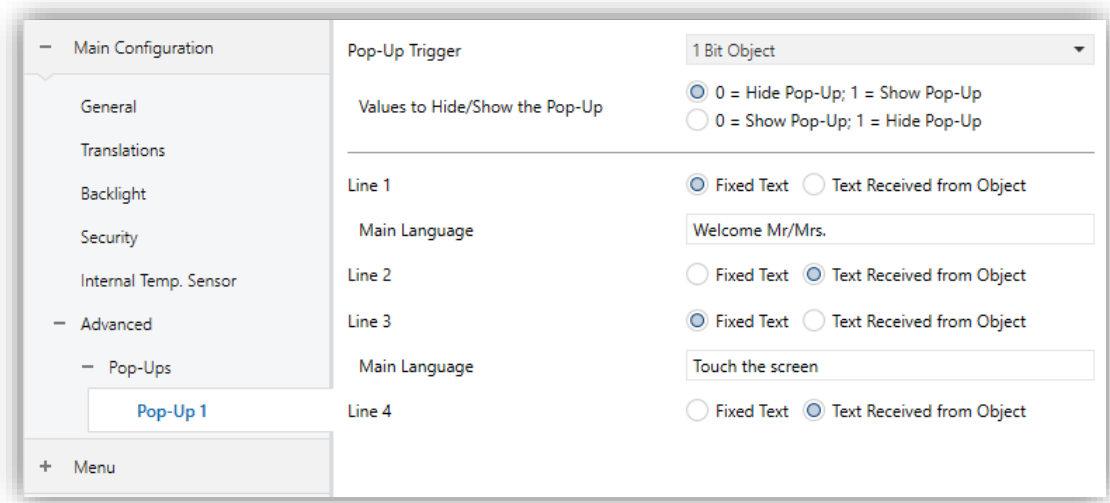

Figure 20. Advanced- Pop-Ups.

For each Pop-up enabled a new tab “Pop-up n” is added with the following parameters:

- **Pop-Up Trigger:**
 - [\[1 Bit Object\]](#): enables the 1-bit object “[General][Pop Up. X] 1 Bit” to show/hide the Pop-Up. The desired value should be set in:
 - **Values to Hide/Show the Pop-Up** [[0 = Hide Pop-Up, 1 = Show Pop-Up](#) / [0 = Show Pop-Up, 1 = Hide Pop-Up](#)].
 - [\[1 Byte Object\]](#): enables the 1- byte object “[General][Pop-Up. X] 1 Byte” to show the Pop-Up. The desired value should be set in:
 - **Object Value to Hide Pop-Up** [[0...255](#)].
 - **Object Value to Show Pop-Up** [[0...255](#)].

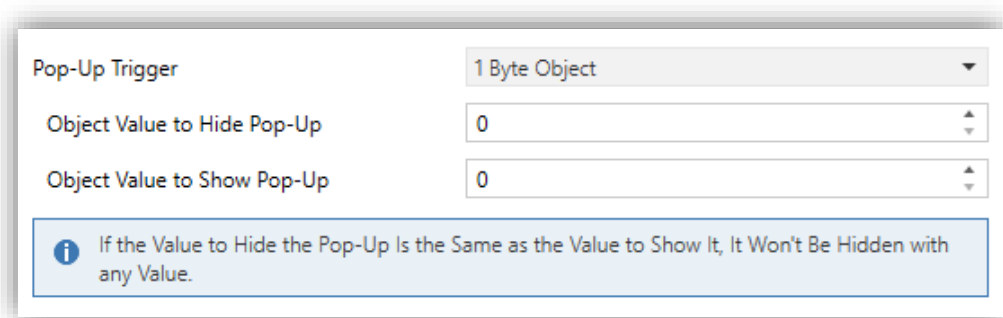

Figure 21. 1-Byte Trigger.

- [Changes in 14 Bytes Objects]: the pop-up message will be displayed when a value is received in one of the 14-byte objects that define the message text.
- **Line [1,4] [Fixed / Text Received from Object]**: sets whether the corresponding text line will be pre-defined or object-dependent. If “Fixed” is selected, the following parameter will appear:
 - **Text**: textbox to enter the desired text for the corresponding line.

Up to four 14-byte objects called “[General][Pop-Up. X] Line X” will appear, depending on how many lines of text have been assigned the “Text Received from Object” option.

3.1.10.3 WELCOME BACK

Z40 can send a specific object (a **one-bit** value, a **scene** value or both, depending on the parameterisation) to the KNX bus when the user presses a touch button or a proximity detection occurs after a significant amount of time since the last press or presence detection. Sending it or not can also depend on an **additional, configurable condition** consisting in the evaluation of up to five binary objects.

Any actions that in normal operation may be executed will not be if the welcome back object is sent to the bus. Thus, if the user presses a button and this causes the welcome back object to be sent, the normal action of that button will not be triggered.

ETS PARAMETERISATION

After enabling **Welcome Back Object** from “Advanced” screen (see section 3.1.10), a new tab will be incorporated into the tree on the left.

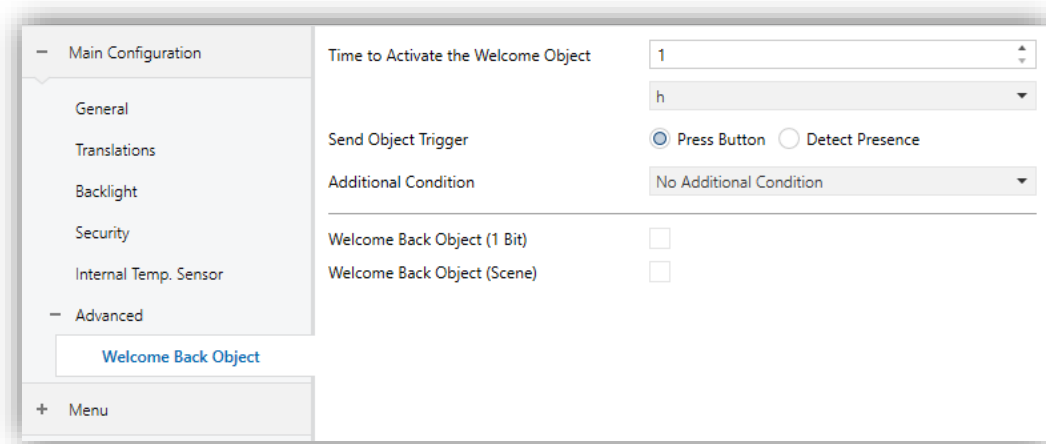

Figure 22. Advanced - Welcome Back Object.

- **Time to Activate the Welcome Object** [[1...65535](#)][s] [[1...65535](#)][min/h]: sets the minimum time that should elapse after the last button touch (or presence detection, when the proximity sensor is enabled) before the next one triggers the execution of the welcome back function.
- **Send Object Trigger** [[Press Button](#) / [Detect Presence](#)]: sets whether the welcome back object is sent after a touch in the screen or when the proximity sensor detects presence.
- **Additional Condition** [[No Additional Condition](#) / [Do Not Send Unless All Additional Conditions are 0](#) / [Do Not Send Unless All Additional Conditions are 1](#) / [Do Not Send at Less One of the Additional Conditions is 0](#) / [Do Not Send at Less One of the Additional Conditions is 1](#)]: condition that must be fulfilled for sending the welcome object. When selecting any condition, the following parameter appears:
 - **Number of Condition Objects** [[1...5](#)]: up to 5 objects can be selected for the additional condition.
- **Welcome Back Object (1 Bit)** [[disabled/enabled](#)]: checkbox to enable the sending of a 1-bit value (through “[**General**] **Welcome back**”) when the welcome back function is triggered and the condition (if any) evaluates to true. The desired value should to be set in **Value** [[Send 0](#) / [Send 1](#)].
- **Welcome Back Object (Scene)** [[disabled/enabled](#)]: checkbox to enable the sending of a scene run request (through “[**General**] **Scene: send**”) when the welcome back function is triggered and the condition (if any) evaluates to true. The desired value should to be set in **Scene Number** [[1...64](#)].

3.2 MENU

The user interface is organised into **pages** (up to **seven** different pages, in addition to the “Configuration Page”), each of which can be accessed from the menu page, which (unless the contrary has been parameterised) is automatically shown after the start-up.

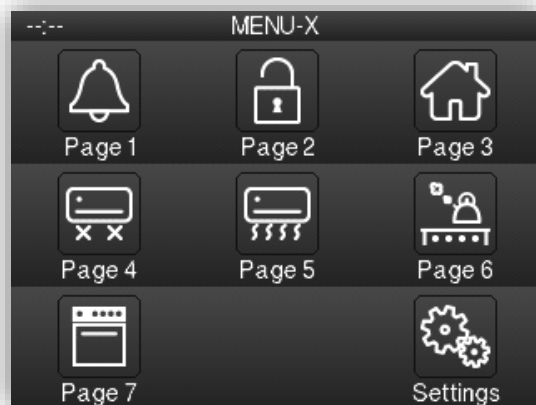

Figure 23. Menu.

Password-protected pages (see section 3.1.4) will display a small icon with a lock next to the lower left corner of the associated button. On the other hand, if a page contains a box with an active alarm (see section 3.3.2.5.5), a small alarm icon will be displayed next to the lower right corner.



Figure 24. Menu with protection and alarms.

The **seven pages** of general purpose can be set to:

- **Normal page:** six general-purpose boxes in which up to six controls/indicators (with different functionalities) can be included, being even possible to combine alarm, climate or any other controls within the same page.



Figure 25. General-purpose page.

It also possible to configure in each box of the last row 2 individual boxes of type indicator, control of a button or direct access to page.



Figure 26. General-purpouse page + 4 boxes below.

- **Thermostat:** page intended exclusively for the control of an external thermostat. Three areas can be distinguished:
 - Left side area: up four boxes can be configured as indicator, 1- button control or page direct link.
 - Central área: allows the control of the setpoint.
 - Right side area: control of the fan speed.



Figure 27. Thermostat page.

- **Thermostat + 2 boxes:** page for controlling an external thermostat with additional general-purpose boxes. 4 areas can be distinguished:
 - Left side area: up four boxes can be configured as indicator, 1- button control or page direct link.
 - Central área: allows the control of the setpoint.
 - Right side area: control of the fan speed.
 - Bottom area: up two general-purpose boxes, with the same formatting as the normal page boxes or up to 4 boxes configurable as indicator, 1- button control or page direct link.



Figure 28. Thermostat + 2 boxes page.



Figure 29. Thermostat + 2 boxes page with left box divided into 2.

The **Configuration Page** is specific-purpose, as it is provided for user customisation of the device.

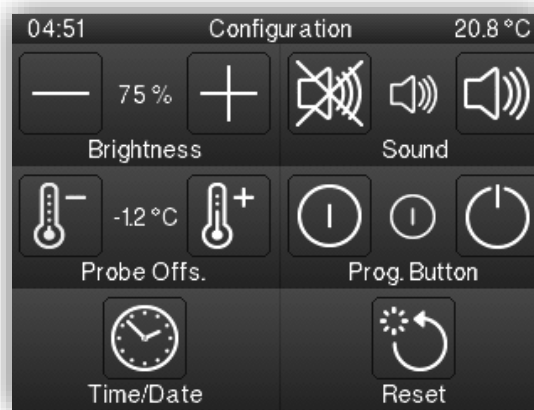

Figure 30. Configuration page.

The user interface will always show on top the title of the current page.

In addition, there is a button below the display at the bottom of the touch, which, if enabled, allows the user to return to the home page. This button is known as the **'Home'** button.

3.2.1 CONFIGURATION

The Menu tab contains only one screen, Configuration.

ETS PARAMETERISATION

+ Main Configuration		Title
- Menu		Main Language
Configuration		Default Page
Page 1	<input type="checkbox"/>	
Page 2	<input type="checkbox"/>	
Page 3	<input type="checkbox"/>	
Page 4	<input type="checkbox"/>	
Page 5	<input type="checkbox"/>	
Page 6	<input type="checkbox"/>	
Page 7	<input type="checkbox"/>	
Configuration Page	<input type="checkbox"/>	

Figure 31. Menu - Configuration.

The parameters available are:

- **Title:**
 - **Language X [Menu]:** text field that defines the title that will be shown on the top of the Menu page for the corresponding language.
- **Default Page [Menu]:** dropdown list that sets the page (Menu, or any of the general-purpose pages) that will behave as the default page. This page will be the one shown after one minute of inactivity, assuming that such page has been enabled and it is not protected with password.

In addition, one checkbox is shown per general-purpose or thermostat type page (that is, pages 1 to 7), as well as one more checkbox for the Configuration page. Each of these checkboxes will allow enabling or disabling the corresponding page in the device – a specific ETS tab will appear upon the activation of a page.

3.3 PAGE n

3.3.1 CONFIGURATION

When any of the general-purpose pages is enabled from the “Configuration” screen under the “Menu” tab, a new tab named **Page n** will appear, where n is the number of the page.

Under this tab, one screen (**Configuration**) will be initially displayed to let the integrator enable or disable each of the boxes in the page. Depending on that, more parameter screens will appear.

ETS PARAMETERISATION

This screen contains the following parameters:

- **Page Type** [[Regular page](#) / [Thermostat](#) / [Thermostat + 2 Boxes](#)]: allows choosing the display format and functionality of the pages.

Page Type	Regular page
Title	
Main Language	Regular page
Automatic Page Shaping	<input checked="" type="radio"/> No <input type="radio"/> Yes
Icon	Home
Protect	<input checked="" type="radio"/> No <input type="radio"/> Yes
Box 1	<input type="checkbox"/>
Box 2	<input type="checkbox"/>
Box 3	<input type="checkbox"/>
Box 4	<input type="checkbox"/>
Box 5	Disabled
Box 6	Disabled

Figure 32. Regular page n - Configuration.

<ul style="list-style-type: none"> Main Configuration <ul style="list-style-type: none"> General Translations Backlight Security Internal Temp. Sensor Advanced Menu <ul style="list-style-type: none"> Configuration Thermostat page 	Page Type: Thermostat Title: Thermostat page Main Language: Icon: Home Protect: <input checked="" type="radio"/> No <input type="radio"/> Yes Box A: <input type="checkbox"/> Box B: <input type="checkbox"/> Box C: <input type="checkbox"/> Box D: <input type="checkbox"/> Setpoint: <input checked="" type="checkbox"/> Fan: <input type="checkbox"/> Alarm: <input type="checkbox"/>
--	---

Figure 33. Thermostat page n - Configuration.

<ul style="list-style-type: none"> Main Configuration <ul style="list-style-type: none"> General Translations Backlight Security Internal Temp. Sensor Advanced Menu <ul style="list-style-type: none"> Configuration Thermostat + 2 boxes page 	Page Type: Thermostat + 2 Boxes Title: Thermostat + 2 boxes page Main Language: Icon: Home Protect: <input checked="" type="radio"/> No <input type="radio"/> Yes Box A: <input type="checkbox"/> Box B: <input type="checkbox"/> Setpoint: <input checked="" type="checkbox"/> Fan: <input type="checkbox"/> Box 5: Disabled Box 6: Disabled Alarm: <input type="checkbox"/>
--	---

Figure 34. Thermostat + 2 Boxes n - Configuration.

- **Title:**
 - **Language X [Page 1]:** text field that defines the title that will be shown on the top of the Menu page for the corresponding language.

In addition, this field allows changing the name of the tab in ETS left menu, as shown in the figures above.

- **Automatic Page Shaping** [[No](#) / [Yes](#)]: allows choosing whether the available boxes should be automatically distributed ("[Yes](#)") depending on the number of boxes configured, or be displayed as a static 3x2 grid ("[No](#)").

Note: only available for "[Regular](#)" type pages with boxes 5 and 6 disabled or configured as general-purpose boxes.

- **Icon** [[Home](#)]: sets the icon that will represent the page in the Menu page.
- **Protect:** sets whether the page will be password-protected or not. Depending on the security levels configured (one or two; see section 3.1.4) this list will contain the following options:

- **One Level:**

- [\[No\]](#): the page will not be protected by password. All users can access it.

- [\[Yes\]](#): the page will be protected by password. Users will be asked to type the password when trying to access it.

- **Two Levels:**

- [\[No\]](#): the page will not be protected by password. All users can access it.

- [\[Level 1\]](#): the page will implement security level 1. To access it, users will be required to enter password 1 or password 2.

- [\[Level 2\]](#): the page will implement security level 2. To access it, users will be required to enter password 2.

- **Boxes:** checkboxes to enable or disable each of the boxes in the page. When enabled, every box will have its own parameter screen (**Box *i* / Setpoint / Fan**) under the corresponding "Page *n*" tab. The 3.3.2 section explains the parameterisation process of these boxes.
- **Alarm** [[disabled/enabled](#)]: to enable an alarm to link, for example, with a window opening sensor. The reception of alarm messages is carried out through the object "**[Pn] Alarm**", causing the setpoint control to disappear and an icon and text to appear. Enabling and disabling the alarm functionality at runtime is also possible through the object "**[Pn] Enable Alarm**".

Note: only available "[Thermostat](#)" and "[Thermostat + 2 boxes](#)" type pages.

Alarm

Trigger Value 0 = No Alarm; 1 = Alarm
 0 = Alarm; 1 = No alarm

Enabling Object Configuration 0 = Disable; 1 = Enable
 0 = Enable; 1 = Disable

	Icon	Color	Representation
Alarm Icon	Window Opened	Upper Level Color	<input checked="" type="radio"/> Permanent <input type="radio"/> Intermittent

Text

Figure 35. Alarm.

- **Trigger Value** [0 = No alarm; 1 = Alarm / 0 = Alarm, 1 = No alarm]: polarity of the binary alarm trigger object.
- **Enabling Object Configuration** [0 = Disabled, 1 = Enabled/0 = Enabled, 1 = Disabled]: polarity of the alarm enabling object.
- **Text**: text that appears in the display when the alarm is activated.

3.3.2 BOX *i*

This screen contains the following parameters common to all type of boxes:

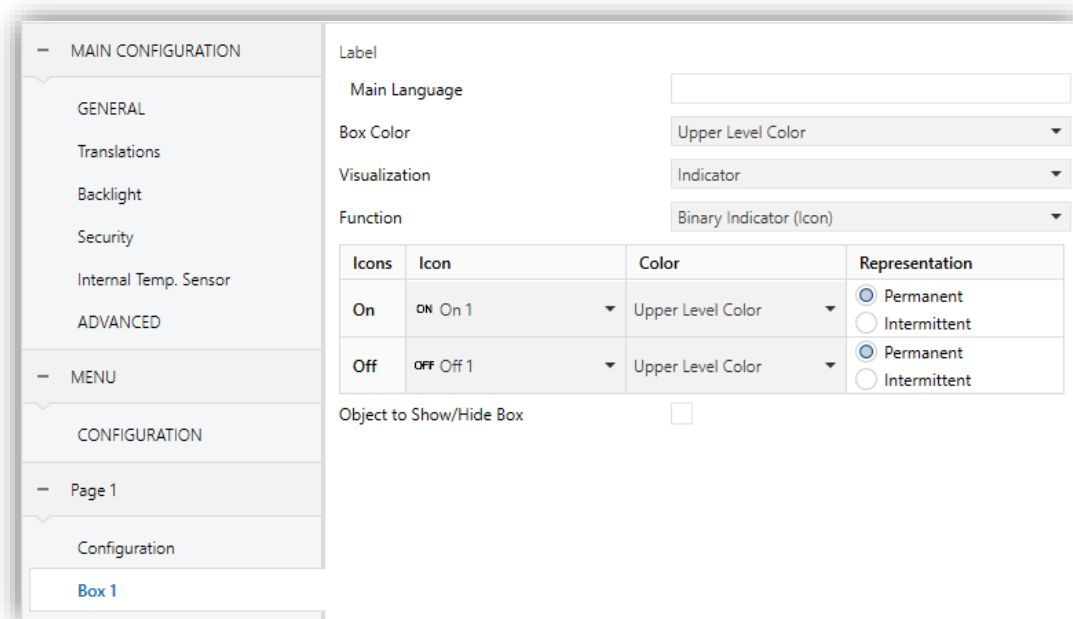

Figure 36. Regular Page - Box *i* - Configuration.

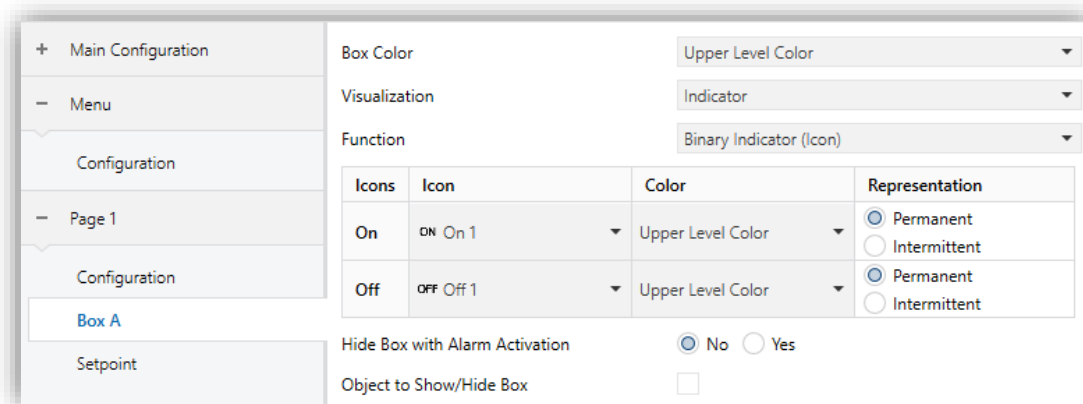

Figure 37. Thermostat Page - Box *i* - Configuration.

● **Label:**

- **Language X:** identifying title for the box for the corresponding language.

In addition, this field will allow changing the name of the tab that appears by default for each page in ETS left menu, as shown in the figures above.

Note: only available for boxes of the “Regular” type pages and boxes 5 and 6 of the “Thermostat + 2 boxes” page.

- **Box Color** [[Upper Level Color / Color select by dropdown](#)]: color mask applicable to the indicators, controls and labels of the box, unless another color is specified for these items. In case of selecting “[Upper Level Color](#)”, the global mask is applied (see section 3.1.1).
- **Visualization**: box format. The available box formats in Z40 are:
 - [[Indicator](#)]: the box will work as a status indicator.
 - [[1-button Control](#)]: the box will work as a one-button control.
 - [[2-button Control](#)]: the box will work not only as a status indicator, but also as a two-button control.
 - [[Climate Control](#)]: the box will act as a climate indicator and a climate control.
 - [[Other](#)]: the box will implement some other special functionality.
- **Function**: depending on the “Visualization” type selected, the parameters below will change. The following sections explain the available parameters depending on the visualization type selected.

A table appears in which it can be configured:

- **Icon** or **Button**: drop-down list with the available icons to show in the indicator(s) and/or button(s) of the box.
- **Color** [[Upper Level Color / Color select by dropdown](#)]: color mask applicable to the indicator(s) and/or button(s) of the box. In case of selecting “[Upper Level Color](#)”, the box mask is used.
- **Representation** [[Permanent/Intermittent](#)]: sets the icon representation.

Note: *this parameter is only available for indicators with an icon.*

The following parameter appears when the alarm is enabled:

- **Hide Box with Alarm Activation** [[No/Yes](#)]: allows you to hide the boxes when the alarm is active.
- Note:** *not available for boxes of the “Regular” type pages and boxes 5 and 6 of the “Thermostat + 2 boxes” page.*

The parameter described below is common to all types of controls:

- **Object to Show/Hide Box** [*disabled/enabled*]: enables or disables a 1-bit object (“**[Pn][Bi] Show/Hide Box**”) to show or hide the corresponding box.

Moreover, it is possible to protect with password boxes that are not indicators:

- **Protect**: sets whether the box will be password-protected or not. This function works in the same way as Page *n* security:

➤ **One Level:**

[No]: the box will not be protected by password. All users can access it.

[Yes]: the box will be protected by password. Users will be asked to type the password when trying to access it.

➤ **Two Levels:**

[No]: the box will not be protected by password. All users can access it.

[Level 1]: the box will implement security level 1. To access it, users will be required to enter password 1 or password 2.

[Level 2]: the box will implement security level 2. To access it, users will be required to enter password 2.

3.3.2.1 INDICATORS

Boxes designed for displaying statuses, showing a numeric or text value, or displaying an icon permanently or intermittently representing the current value of a communication object.

The functions and the related parameters available in Z40 are:

3.3.2.1.1 Binary Indicator (Icon)

The box will behave as a binary state indicator. Each of the two states will be shown in the box through the selected icon.

When this function is assigned to the box, the “**[Pn][Bi] Binary indicator**” communication object become available, as well as a table that permit selecting the icon to be displayed when the object acquires the value “0” (**Icon Off**) and the icon to be displayed when it acquires the value “1” (**Icon On**) will be displayed, the color and the representation.

Icons	Icon	Color	Representation
On	ON On 1	Upper Level Color	<input checked="" type="radio"/> Permanent <input type="radio"/> Intermittent
Off	OFF Off 1	Upper Level Color	<input checked="" type="radio"/> Permanent <input type="radio"/> Intermittent

Figure 38. Binary Indicator (Icon).

Therefore, when the device receives the values “0” or “1” through the aforementioned object, the box will show one icon or another.

3.3.2.1.2 Binary Indicator (Text)

The box will behave as a binary state indicator. Each of the two states will be shown in the box through a different label.

When the box is assigned this function, the “[Pn][Bi] Binary indicator” object will become available, as well as the parameters that permit typing the text to be shown when the object receives a “0” (**Text Off**) and that to be shown when it becomes “1” (**Text On**) will be displayed.

Figure 39. Binary Indicator (Text).

Therefore, when the device receives the values “0” or “1” through the aforementioned object, the box will show one text or another.

3.3.2.1.3 Enumerated Indicator (Icon)

The box will behave analogously to the case of the Binary indicator, (Icon) however, it will be possible to distinguish up to 6 states (configurable through the **# Enums** parameter) instead of only two. The states will be determined by the reception of any values between 0 and 255.

	Value	Icon	Color	Representation
Value 1	0	OFF Off 1	Upper Level C...	<input checked="" type="radio"/> Permanent <input type="radio"/> Intermittent
Value 2	0	OFF Off 1	Upper Level C...	<input checked="" type="radio"/> Permanent <input type="radio"/> Intermittent

Figure 40. Enumerated Indicator (Icon).

When this function is assigned to the box, a 1-byte communication object, “[Pn][Bi] Enumerated Indicator”, will become available as well as a series of parameters (**Value**, **Icon**, **Color** and **Representation**) for each of the states to be distinguished will be available too. This allows setting which icon will be shown in the box, with a specific color and representation, upon the reception of which value through the communication object.

3.3.2.1.4 Enumerated Indicator (Text)

The box will behave analogously to the case of the Binary indicator (Text) however it will be possible to distinguish up to 6 states (configurable through the **# Enums** parameter) instead of only two. The states will be determined by the reception of any values between 0 and 255.

	Value	Text
Value 1	0	
Value 2	0	

Figure 41. Enumerated Indicator (Text).

When this function is assigned to the box, one 1-byte communication object, “[Pn][Bi] Enumerated Indicator”, will become available as well as two additional parameters (**Value** and **Text**) will be displayed for each of the states to be distinguished. This allows setting which texts will be displayed in the box upon the reception of which values through the communication object.

3.3.2.1.5 Numerical Indicators

The box will behave as a numerical state indicator that displays the value of the communication object enabled when the function is assigned to the box.

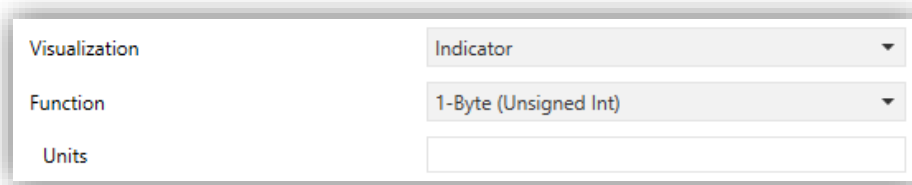

Figure 42. Numerical Indicator.

The range of values allowed for each type and the name of the corresponding object are included in the following table.

Function	Range	Related Object
1-Byte (Unsigned Int)	0– 255	[Pn][Bi] 1-byte Unsigned Int Indicator
1-Byte (Signed Int)	-128 – 127	[Pn][Bi] 1-byte Signed Int Indicator
Percentage Indicator	0 – 100	[Pn][Bi] Percentage Indicator
Temperature Indicator	-99 – 199	[Pn][Bi] Temperature Indicator
2-Byte (Unsigned Int)	0 – 65535	[Pn][Bi] 2-byte Unsigned Int Indicator
2 -Byte (Signed Int)	-32768 – 32767	[Pn][Bi] 2-byte Signed Int Indicator
2 -Byte (Float)	-671088,64 – 670433,28	[Pn][Bi] 2-byte Float Indicator
4-Byte (Signed Int)	-2147483648 – 2147483647	[Pn][Bi] 4-byte Signed Int Indicator
4-Byte (Float)	-2147483648 – 2147483647	[Pn][Bi] 4-byte Float Indicator

Table 2. Numerical Indicators.

In all cases (except percentage and temperature indicators) the integrator will be shown a text field (**Unit**), empty by default that permits specifying the measuring units of the displayed value.

For percentage indicators, the symbol % always will be displayed as unit. Temperature indicators will be displayed in °C or °F depending on the selected scale (by the object to change scale, see section 3.1.10).

Moreover, the following parameter is included for the temperature indicator:

- **Include Plus Sign before Positive Number** [*disabled/enabled*]: asets whether showing or not the “+” sign before the positive temperature values.

3.3.2.1.6 14-byte Text Indicator

The box will show the text received through the communication object “[Pn][Bi] 14-Byte Text Indicator”.

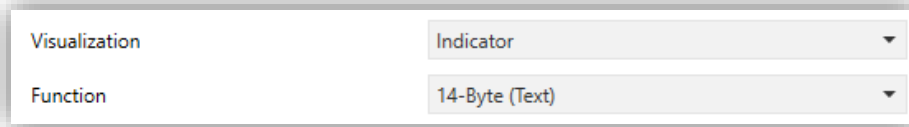

Figure 43. 14-byte text indicator.

Note: objects associated to the text indicators are stored in salved zone, so its value will be maintained after a restart.

3.3.2.2 1-BUTTON CONTROL

Boxes configured as 1-button controls show one centred button and a title. There is a parameter (**Function**) that will select the specific function that the box will play.

3.3.2.2.1 Switch

The central button of the box will react to user presses by sending a binary value to the bus through the “[Pn][Bi] Binary control” object, which turns visible as soon as this function is assigned to the box. In addition, this control will have associated a dedicated object for the box indicator (“[Pn][Ci] Binary Indicator”), which is automatically updated after the control order is sent and can also receive values from the bus.

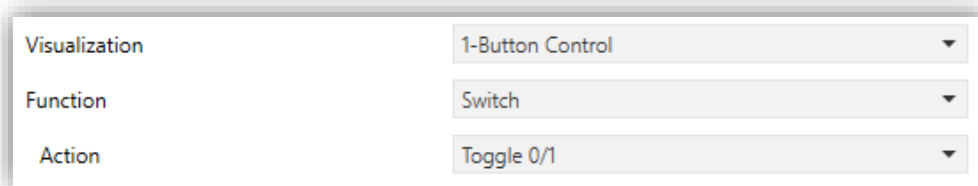

Figure 44. 1-Button Control - Switch.

On the other hand, **Action** permits setting what value will be sent to the bus through the mentioned object, and on what events. The options are:

- [\[Send 0\]](#): one “0” will be sent whenever the button is pressed.
- [\[Send 1\]](#): one “1” will be sent whenever the button is pressed.
- [\[Toggle 0/1\]](#): alternate sending of the values “1” and “0”.

3.3.2.2.2 Two Objects (Short Press/Long Press)

The central button in the box will react differently to a short press and to a long press, setting a time threshold to distinguish both types of press by parameter. The control responds to these presses by sending a binary value to the bus.

Different objects are used to send values for short and long pulsations: "[Pn][Bi] Two objects - Short press" and "[Pn][Bi] Two objects - Long press".

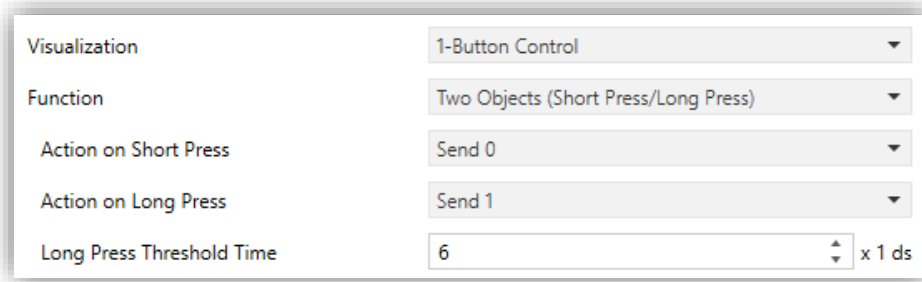

Figure 45. 1-Button Control - Two Objects (Short Press/Long Press).

On the other hand, the parameter called **Action** permits setting what value will be sent to the bus through the mentioned objects, and on what events. The actions available for each type of press are:

- [\[Send 0\]](#): a "0" will be sent whenever the button is pressed.
- [\[Send 1\]](#): a "1" will be sent whenever the button is pressed.
- [\[Toggle 0/1\]](#): alternate sending of the values "1" and "0".
- [\[Send 1-Bit Unsigned Int Value\]](#): the 1-Byte Unsigned Integer value indicated in **Value** will be sent whenever the button is pressed.

If the option chosen is [Send 0/Send 1/Toogle 0/1](#), the object "[Pn][Ci] Two Objects - Indicator" will appear for the box indicator. The button icon will change with the value sent by the short press and/or the one received by this indicator object.

To distinguish optimally a short press and a long press, Z40 includes a parameter called **Long Press Threshold Time** [\[4...6...50\]\[ds\]](#), that sets the minimum time the user should hold the button in order to consider it a long press.

3.3.2.2.3 Hold & Release

This control function allows the user to configure sending a binary value on pressing and a different binary value on releasing the button, through the 1-bit object "[Pn][Bi] Hold & Release". In addition, this control will have associated a dedicated object for the indicator ("[Pn][Ci] Hold & Release - Indicator"). The button icon will change with the value sent by the short press and/or the one received by this indicator object.

The screenshot shows a configuration window for a 1-Button Control. The 'Visualization' is set to '1-Button Control' and the 'Function' is 'Hold & Release'. Under 'Action on Hold', the 'Send 1' radio button is selected. Under 'Action on Release', the 'Send 0' radio button is selected.

Figure 46. 1-Button Control - Hold & Release.

Through the parameters **Action on Hold** [[Send 0](#) / [Send 1](#)] and **Action on Release** [[Send 0](#) / [Send 1](#)] permit setting what value will be sent to the bus for each case.

3.3.2.2.4 Scene

The central button of the box will react to the different pulses by sending a scene value to the KNX bus through the "[General] Scenes: send" object or through an individual scene object "[Pn][Bi] Scene: Send" for this box depending on the option selected in the parameter **Object to Use** [[General Scene Object](#) / [Individual Box Scene Object](#)].

The screenshot shows a configuration window for a 1-Button Control. The 'Visualization' is set to '1-Button Control' and the 'Function' is 'Scene'. Under 'Action', the 'Run' radio button is selected. The 'Scene Number' is set to '1'. Under 'Object to Use', the 'General Scene Object' radio button is selected.

Figure 47. 1-Button Control - Scene.

Parameter **Scene number** [[1...64](#)] permits specifying the number of the scene to be sent. Moreover, through the parameter called **Action** [[Run Scene](#) / [Run and Save](#)], sets whether the device will only send scene execution orders (after a short press) or if it will be possible, in addition to sending execution orders upon short presses, to send scene save orders in the case of a long press.

3.3.2.2.5 Numerical Constant Controls

Whether the box is assigned any of the remaining “constant” control options, the central button in the box will react to user presses by sending a certain numerical value, which is required to be specified under **Constant value**. This numerical value will depend on the constant control type selected to the box (**Function**).

Figure 48. 1-Button Control - Numerical Constant.

Table 3 shows, for every available Function, the permitted value range and the name of the object through which the values are sent to the bus.

Function	Size	Sign	Range	Related Object
Counter	<u>1-Byte</u>	<u>Signed</u>	<u>[-128...0...127]</u>	[Pn][Bi] 1-Byte Signed Int Control
		<u>Unsigned</u>	<u>[0...255]</u>	[Pn][Bi] 1-Byte Unsigned Int Control
	<u>2-Byte</u>	<u>Signed</u>	<u>[-32768...32767]</u>	[Pn][Bi] 2-Byte Signed Int Control
		<u>Unsigned</u>	<u>[0...65535]</u>	[Pn][Bi] 1-Byte Unsigned Int Control
Scaling	1-Bte		<u>[0... 100]</u>	[Pn][Bi] Percentage Control
Float	2-Byte		<u>[-671088.64...0...670433.28]</u>	[Pn][Bi] 2-Byte Float Control

Table 3. Numerical Constant Control.

3.3.2.2.6 Enumeration

The box will behave analogously to the case of the switch, however the communication objects (control object “[Pn][Ci] Enumeration Control” and the status “[Pn][Ci] Enumeration Indicator”) will be 1-byte and up to six states can be distinguished.

Visualization	1-Button Control		
Function	Enumeration		
# Enums	2		
	Value	Icon	Color
Value 1	0	OFF Off 1	Upper Level Color
Value 2	1	OFF Off 1	Upper Level Color

Figure 49. 1-Button Control - Enumeration

- **# Enums** [1...2...6]: sets the number of states in the enumerated list. For every distinguished state, the parameter **Value** [0...255] will become available together with the corresponding indicator.

3.3.2.2.7 Room State

Configuring with this function the box, controlling the states of the room will be possible. Thus, pressing on the button will cause the room status to switch between *Normal*, *Make Up Room* and *Do Not Disturb*. The switched values are sent to the bus via the 1-byte object “[Pn][Ci] Room State”.

Visualization	1-Button Control		
Function	Room State		
Show Pop-Up When Activating Normal State	No		
Show Pop-Up When Activating MUR	No		
Show Pop-Up When Activating DND	No		
	Icon	Color	
Normal	Room Normal State	Upper Level Color	
MUR	Clean Room 1	Upper Level Color	
DND	Do Not Disturb 1	Upper Level Color	

Figure 50. 1-Button Control - Room State.

- **Show Pop-Up When Activating Normal:** [No / Pop-Up 1/.../ Pop-Up 6]: allows to select the pop-up to be displayed when the Normal mode is activated.

- **Show Pop-Up When Activating MUR:** [[No](#) / [Pop-Up 1](#) / ... / [Pop-Up 6](#)]: allows to select the pop-up to be displayed when the Make Up Room mode is activated.
- **Show Pop-Up When Activating DND:** [[No](#) / [Pop-Up 1](#) / ... / [Pop-Up 6](#)]: allows to select the pop-up to be displayed when the Do Not Disturb mode is activated.

Note: *the pop-ups selected must be activated (see section 3.1.10.2).*

This control will have associated a dedicated object for the indicator (“**[Ci] Room State Indicator**”), which is automatically updated after the control order is sent and when values are received from the bus.

3.3.2.3 2-BUTTON CONTROL

Boxes configured as 2-button controls consist in an indicator and two buttons that, when touched, trigger the sending of an action to the KNX bus through a certain object.

As a general rule, most of the 2-button controls permit configuring a pair of parameters, **Left button** and **Right button**, each containing a dropdown list for the selection of the icons to be displayed inside the buttons in the box.

Note: *When multiple presses are made consecutively on the buttons of a control that regulates (e.g. increases / decreases) the value of a certain variable, only the final value selected by the user will be sent to the bus, to prevent an unnecessary bus traffic due to all the intermediate values.*

On the other hand, the **Function** parameter contains a dropdown list for the selection of the particular two-button control type to be assigned to the box. The available options (and their related parameters) are:

3.3.2.3.1 Switch

When the user presses any of the buttons, Z40 will send a parameterized binary value to the bus through the object "**[Pn][Bi] Switch**", while the status object "**[Ci] Binary Indicator**" will determine the icon or text shown in the box. The indicator will be updated automatically after each control order and when receiving values from the bus.

Icons	Icon	Color	Representation
On	Light On 1	Upper Level Color	<input checked="" type="radio"/> Permanent <input type="radio"/> Intermittent
Off	Light Off 1	Upper Level Color	<input checked="" type="radio"/> Permanent <input type="radio"/> Intermittent

Figure 51. 2-Button Control - Switch.

The parameters available are:

- **Action** [Left = 0; Right = 1 / Right = 0; Left = 1]: sets the value to be sent when pressing each of the two buttons.
- **Indicator Type** [Text / Icon]: sets whether the indicator of the control will be a text indicator (two text fields will be displayed to introduce the corresponding texts for “0” and “1”) or an icon indicator (two drops lists will be displayed to select the corresponding icons for “0” and “1”).

3.3.2.3.2 Switch + Indicator

Like the previous control, when the user presses any of the buttons, Z40 will send a parameterized binary value to the bus through the object "**[Pn][Bi] Switch**". However, the indicator is independent; it will be updated according to the value received by the dedicated object.

Figure 52. 2-Button Control - Switch + Indicator.

- **Action** [Left = 0; Right = 1 / Right = 0; Left = 1]: sets the value to be sent when pressing each of the two buttons.

- **Indicator Type** [[Counter](#) / [Scaling](#) / [Temperature](#)]: sets the indicator type. According to the selected indicator the objects “[Pn][Bi] x-Byte Signed Int Indicator”, “[Pn][Bi] Percentage Indicator”, “[Pn][Bi] Temperature Indicator” will be enabled respectively.

When selecting “Counter” type, the following parameters appear:

- **Size** [[1 Byte](#) / [2 Bytes](#) / [4 Bytes Signed Int](#)]: size of the indicator object.
- **Sign** [[Signed](#) / [Unsigned](#)]: sign of the indicator object.
- **Unit**: text field to set the measurement unit displayed next to the indicator.

3.3.2.3.3 Two Objects (Short Press/Long Press)

Control for sending specific binary values both after a short or a long press on any of the two buttons (i.e., they will work as a joint control; for independent buttons, please configure them as 1-button controls). Two different objects are used to send values for short and long pulsations, “[Pn][Bi] Two objects - Short Press” and “[Pn][Bi] Two objects - Long Press”.

The screenshot shows a configuration window for a 2-Button Control. The 'Visualization' is set to '2-Button Control' and the 'Function' is 'Two Objects (Short Press/Long Press)'. For both 'Action on Short Press' and 'Action on Long Press', the radio button for 'Left = 0; Right = 1' is selected. The 'Long Press Threshold Time' is set to 6 x 1 ds. The 'State Object' is 'Short Press Object' and the 'Indicator Type' is 'Icon'. Below these settings is a table for configuring icons and their representations.

Icons	Icon	Color	Representation
Off	Light Off 1	Upper Level Color	<input checked="" type="radio"/> Permanent <input type="radio"/> Intermittent
On	Light On 1	Upper Level Color	<input checked="" type="radio"/> Permanent <input type="radio"/> Intermittent

Figure 53. 2-Button Control - Two Objects (Short Press/Long Press).

- **Action on Short / Long press** [[Left = 0; Right = 1](#) / [Right = 0; Left = 1](#)]: sets the value to be sent when short / long pressing each of the two buttons.

- **Long Press Threshold Time** [4...6...50], sets the minimum time the user should hold the button in order to consider it a long press.
- **State Object** [[Short Press Object](#) / [Long Press Object](#)]: allows setting the control command to which the status indicator, "[Pn][Bi] Two Objects - Indicator", will obey. This object can also receive values from the bus.
- **Indicator Type** [[Text](#) / [Icon](#)]: sets whether the indicator of the control will be a text indicator (two text fields will be displayed to introduce the corresponding texts for "0" and "1") or an icon indicator (two drops lists will be displayed to select the corresponding icons for "0" and "1").

3.3.2.3.4 Numerical Controls (Counter, Scaling and Float)

If the box is assigned any of the numerical functions "[Counter](#)", "[Scaling](#)" or "[Float](#)", user touches over the buttons will trigger the sending of a certain numerical value to the bus. This value will be progressively increased or decreased with every touch on one button or the other, through the control object, while the box itself will permanently reflect the current value of the control object and/or the corresponding status object. This object can also receive values from the bus.

Visualization	2-Button Control
Function	Counter
Action	<input checked="" type="radio"/> Left = Decrease; Right = Increase <input type="radio"/> Left = Increase; Right = Decrease
Size	<input checked="" type="radio"/> 1 Byte <input type="radio"/> 2 Bytes
Sign	<input checked="" type="radio"/> Signed <input type="radio"/> Unsigned
Minimum Value	-128
Maximum Value	127
Increment on Short Press	1
Increment on Long Press	10

Figure 54. 2-Button Control - Numeric.

The parameters available are:

- **Action** [[Left = Decrease; Right = Increase](#) / [Left = Increase; Right = Decrease](#)]: sets which of the two buttons will increase the current numerical value and which will decrease it on user presses.

- **Minimum Value:** sets which value from the available range will be the minimum value permitted by the control after a number of presses on the decrease button.
- **Maximum Value:** sets which value from the available range will be the maximum value permitted by the control after a number of presses on the increase button.
- **Increment on Short Press:** sets the increase or decrease to be applied to the current value on every short press over the increase or decrease buttons, respectively.
- **Increment on Long Press:** sets the increase or decrease to be applied to the current value on every long press over the increase or decrease buttons, respectively.

Whether the selected **function** is counter type, two additional options will be enabled:

- **Size** [[1 Byte](#) / [2 Bytes](#)]: size of the indicator object.
- **Sign** [[Signed](#) / [Unsigned](#)]: sets whether the range includes negative values or only positive values.

The different types of configurable 2-buttons controls are listed in the following table:

Function	Size	Sign	Minimum Value	Maximum Value	Increment on short press	Increment on long press	Related Object
<i>Counter</i>	1 Byte	Signed	[-128...127]	[-128...127]	[1...127]	[1...10...127]	[Pn][Bi] 1-Byte Signed Int Indicator [Pn][Bi] 1-Byte Signed Int Control
		Unsigned	[0...255]	[0...255]	[1...255]	[1...10...255]	[Pn][Bi] 1-Byte Unsigned Int Indicator [Pn][Bi] 1-Byte Unsigned Int Control
	2 Byte	Signed	[-32768...32767]	[-32768...32767]	[1...32767]	[1...32767]	[Pn][Bi] 2-Byte Signed Int Indicator [Pn][Bi] 2-Byte Signed Int Control
		Unsigned	[0...65535]	[0...65535]	[1...65535]	[1...65535]	[Pn][Bi] 2-Byte Unsigned Int Indicator [Pn][Bi] 2-Byte Unsigned Int Control
<i>Scaling</i>	1 Byte		[0...100]	[0...100]	[1...100]	[1...10...100]	[Pn][Bi] Percentage Indicator [Pn][Bi] Percentage Control
<i>Float</i>	2 Byte		[-671088,64...670433,28]	[-671088,64...670433,28]	[0,1...0,5...670433,28]	[0,1...1...670433,28]	[Pn][Bi] 2-Byte Float Indicator [Pn][Bi] 2-Byte Float Control

Table 4. 2-buttons Numeric Control.

3.3.2.3.5 Enumeration

The box will behave analogously to the case of the switch control, however the communication objects (control object “[Pn][Bi] Enumeration Control” and the status “[Pn][Bi] Enumeration Indicator”) will be 1-byte. Up to six discrete states can be distinguished depending on the value that the status object acquires from the control or receives from the bus.

	Value	Icon	Color	Representation
Value 1	0	OFF Off 1	Upper Level Color	<input checked="" type="radio"/> Permanent <input type="radio"/> Intermittent
Value 2	1	OFF Off 1	Upper Level Color	<input checked="" type="radio"/> Permanent <input type="radio"/> Intermittent

Figure 55. 2-Button Control - Enumeration.

The parameters available are:

- **# Enums** [1...6]: number of states that will be distinguished. For every distinguished state, the parameter **Value** [0...255] will become available together with the corresponding indicator (either **Text** or **Icon**).
- **Indicator Type** [*Icon* / *Text*]: sets whether the indicator of the control will be a text or an icon. If a **text indicator** is selected, a textbox will be added for each state. In the caso of an **icon indicator**, a drop list will be added for each state to set the corresponding icon.

3.3.2.3.6 Shutter

Shutter control permits sending move up, move down (“**[Pn][Bi] Move Shutter**”) or stop (“**[Pn][Bi] Stop Shutter**”) to control a shutter actuator connected to the bus by pressing the buttons in the box. In addition, the box will contain an indicator that will permanently show, as a percentage, the value of the status object (“**[Pn][Bi] Shutter Position**”).

Figure 56. 2-Button Control - Shutter.

- **Action** [Left = Downwards; Right = Upwards / Right = Upwards; Left = Downwards] sets which of the two buttons will send the move up orders and which the move down orders.
- **Type parameter:**
 - [Standard]: a long press will make the device send to the KNX bus an order to start moving the shutter (upwards or downwards, depending on the button), while a short press will make it send a stop order.
 - [Hold & Release]: as soon as the button is held, the device will send the KNX bus an order to start moving the shutter (upwards or downwards, depending on the button). Once the button is released, it will send an order to stop the shutter.
- **Show Percentage indicator** [disabled/enabled]: enables or disables the shutter position indicator (in percentage) in the box.

3.3.2.3.7 Dimmer

The light control function permits making use of the two buttons in the box to send orders to a light dimmer, either through a binary object or through a 4-bit object. Moreover, the box will permanently display the current value of the dimming status object (“**[Pb][Bi] Light – Dimming Indicator**”), which needs to be linked to the analogous object from the dimmer (as it does not get automatically updated on button presses).

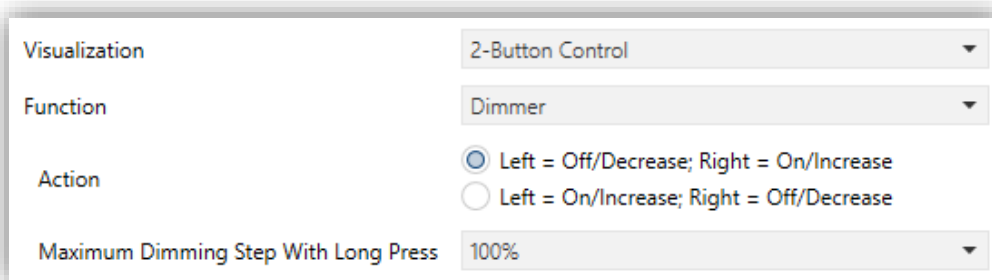

Figure 57. 2-Button Control - Dimmer.

The parameters available are:

- **Action** [Left = Off/Decrease; Right = On/Increase / Left = On/Increase; Right = Off/Decrease]: sets which of the two buttons will send the “turn on” orders and which the “turn off” orders. Options are “Left Off, Right On” (default) and “Left On, Right Off”.

- **Maximum Dimming Step With Long Press** [[100%](#) / [50%](#) / [25%](#) / [12.5%](#) / [6.25%](#) / [3.1%](#) / [1.5%](#)]: sets the increase or decrease in the light level that will be requested, via object “[Pb][Bi] Light – Dimming”, from the dimmer with each long press on the right or left button respectively.

After a short press on the “turn on” button the value “1” will be sent through the “[Pb][Bi] Light - On/Off” binary object, while a short press on the “turn off” button will trigger the sending of the value “0”.

Note: *most light dimmers implement light step dimming progressively (i.e., sending a dimmer a step order of 25% typically does not imply that the light level is suddenly incremented/decremented by 25%, but a progressive increment or decrement of the light level by 25% which is in fact interrupted if a stop order arrives (such order is sent by Z40 when the user releases the button)). Due to this behaviour, it is advised to parameterise dimming steps of 100%, so that the user can perform a complete dimming (from totally off to totally on, or vice versa) or a partial dimming by simply holding the button and then releasing it as soon as he gets the desired light level, therefore with no need of performing successive long presses for regulations greater than the parameterised step.*

3.3.2.3.8 Multimedia

Tapping on one of the two buttons will make Z40 send a binary value to the bus, while pressing on the other will make it send the inverse binary value.

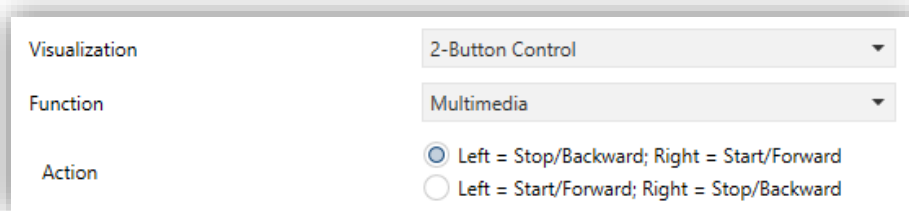

Figure 58. 2-Button Control - Multimedia.

- **Action** [[Left = Stop/Backward; Right = Start/Forward](#) / [Left = Start/Forward; Right = Stop/Backward](#)]: sets which of the two buttons will send the Stop/Backward orders and which one the Start/Forward orders.

The orders will be sent to the bus through the 1-bit object “[Pn] [Bi] Multimedia”, while the indicator values should be received through the object “[Pn] [Bi] Multimedia Indicator”.

3.3.2.3.9 Room State

Configuring with this function the box, controlling the states of the room will be possible, as well as show the associated pop-up. Thus, pressing on the top button will cause the room status to switch between *normal* and *Make Up Room*, while with the bottom button, the state will be switch between *normal* and *Do Not Disturb*. The switched values are sent to the bus via the 1-byte object "[Pn][Ci] Room State".

Button	Icon	Color	Color in Active State
MUR	Clean 2	Upper Level Color	Upper Level Color
DND	Do Not Disturb	Upper Level Color	Upper Level Color

Figure 59. 2-Buttons Control - Room State.

- **Show Pop-Up When Activating Normal State** [[No](#) / [Pop-Up 1](#) / ... / [Pop-Up 6](#)]: allows to select the pop-up to be displayed when *normal* mode is activated.
- **Show Pop-Up When Activating MUR** [[No](#) / [Pop-Up 1](#) / ... / [Pop-Up 6](#)]: allows to select the pop-up to be displayed when *Make Up Room* mode is activated.
- **Show Pop-Up When Activating DND** [[No](#) / [Pop-Up 1](#) / ... / [Pop-Up 6](#)]: allows to select the pop-up to be displayed when *Do Not Disturb* mode is activated.

Note: *the pop-ups selected must be activated (see section 3.1.10.2).*

This control will have associated a dedicated object for the indicator (“[Pn][Ci] Room State Indicator”), which is automatically updated after the control order is sent and when values are received from the bus.

3.3.2.4 CLIMATE CONTROL

This category covers a set of functions related to the climate control. The available options for **Function** (and for the dependent parameters) are detailed in the following sections.

3.3.2.4.1 Temperature Setpoint

This function permits **controlling the temperature setpoint of an external thermostat** by means of a two-button box and of the objects enabled to that effect: "[Pn][Bi] **(Climate) Temperature Setpoint**" for the control and "[Pn][Bi] **(Climate) Temperature Indicator** " for the status.

In addition, the box itself will permanently reflect the value in °C (o °F) of the status object, whose value gets automatically updated after sending control orders (that is, after pressing the buttons), being even possible to receive values from the bus, for example, from the corresponding setpoint status object from the external thermostat.

Therefore, after every press on the temperature increment button, the bus will be sent (through the control object) a certain value, progressively increased on every button press until the parameterisable maximum setpoint value has been reached. Analogously, after every press on the temperature decrement button, the bus will be sent a progressively decreased value until the parameterisable minimum setpoint value has been reached.

Visualization	Climate Control
Function	Temperature Setpoint
Action	<input checked="" type="radio"/> Left = Decrease; Right = Increase <input type="radio"/> Left = Increase; Right = Decrease
Minimum Value	10 °C
Maximum Value	30 °C
Increment on Short Press	0.5 °C
Increment on Long Press	1 °C
Include Plus Sign before Positive Numbers	<input type="checkbox"/>

Figure 60. 2-Button Control - Climate - Temperature Setpoint.

The available parameters are:

- **Action** [Left = Decrease; Right = Increase / Right = Increase; Left = Decrease] sets which of the two buttons will permit increasing the setpoint value and which one will permit decreasing it.
- **Minimum Value** [-99...10...199]: minimum value than can be reached by the control after a number of presses on the decrease button

- **Maximum Value** [-99...30...199]: maximum value than can be reached by the control after a number of presses on the increase button.
 - **Increment on Short Press** [0.1...0.5...10]: sets the increase or decrease step to be applied to the current value on every short press over the increase or decrease buttons, respectively.
 - **Increment on Long Press** [0.1...1...10]: sets the increase or decrease step to be applied to the current value on every long press over the increase or decrease buttons, respectively.
- Note:** Long and short increments are applied in °C regardless of the scale used.
- **Include Plus Sign before Positive Number** [disabled/enabled]: sets whether showing or not the “+” sign before positive temperature values.

3.3.2.4.2 Mode

This function turns the box into a climate mode control.

When this type of mode control is assigned to the box, two communication objects are enabled: the “[Pn][Bi] (Climate) Mode Control” control object, and the “[Pn][Bi] (Climate) Mode Indicator” status object. Depending on the mode selected by the user, the control object will be sent to the bus a certain value, after which the box will display the icon that corresponds to the new mode.

Two mode control types are possible: **Heat/Cool** control type and **Extended (HVAC)** control type.

- **Mode Type:**
 - [Heat/Cool]: Selecting this type of mode control turns the box into a 2-button control one of which will activate the Heat mode, while the other one will activate the Cool mode. A centred indicator will reflect, as an icon, the currently active mode.

Depending on the mode selected by the user, the control object will be sent to the bus a certain value (see Table 5). Also, the box indicator will automatically alternate between one icon and another when a mode change is performed.

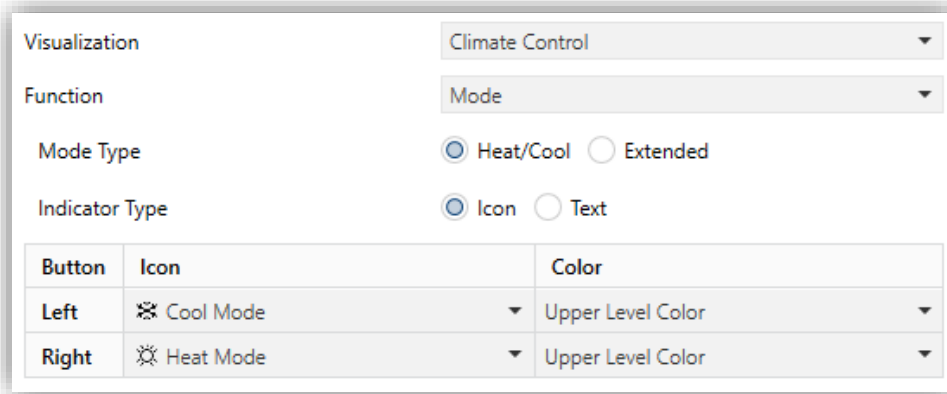

Figure 61. 2-Button Control - Climate - Mode (Heat/Cool).



Mode	Icon	Sent Value
Cool		0
Heat		1

Table 5. Heat/Cool Mode vs. Icons vs. Object Value.

- **[Extended]:** Selecting this type of mode control turns the box into a 2-button control, which permit sequentially commuting among the different HVAC climate modes. A centred indicator will reflect, as an icon, the currently active mode.

Up to five modes [[Auto / Heat / Cool / Fan / Dry](#)] are available, each of which can be in ETS by means of the proper checkbox, which permits setting which of all the five extended modes will be included into the sequential scrolling implemented by the buttons.

Depending on the mode selected by the user, the control object will be sent to the bus a certain value (see Table 6), after which the box will display the icon that corresponds to the new mode. Additionally, if the status object receives from the bus a value that represents any of the modes, the box will adopt the corresponding icon, while if an unrecognised value is received, no icon will be shown.

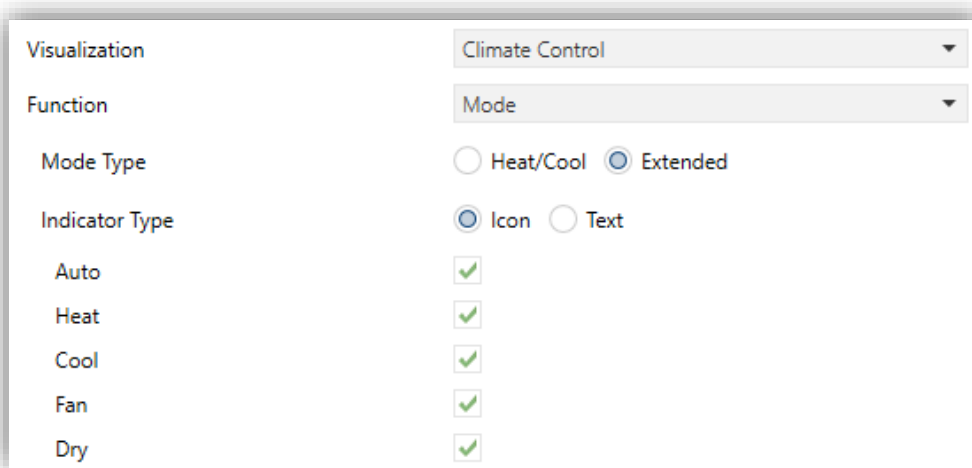

Figure 62. 2-Button Control - Climate - Mode Extended.





Mode	Icon	Sent Value
Auto		0 (0x00)
Heat		1 (0x01)
Cool		3 (0x03)
Fan		9 (0x09)
Dry		14 (0x0E)

Table 6. HVAC Mode vs. Icon vs. Object Value.

- **Indicator Type** [[Icon](#) / [Text](#)]: allows selecting whether the status indicator which each value is represented will be text type or icon type. If text type is set, as many text boxes will be displayed as modes have been enabled. The icons are fixed (see Table 5 and Table 6).

3.3.2.4.3 Fan

This function implements a 2-button (increase/decrease) fan control, as well as an icon indicator.

When this function is assigned to the box, a control object and a 1-byte status object “[Pn][Bi] (Climate) Fan Indicator” are enabled. The status object (which needs to be linked to the status object of the fan actuator) will express, as a percentage, the value of the current fan level, which will be represented with a variable icon on the box.

Visualization	Climate Control
Function	[Climate] Fan
Action	<input checked="" type="radio"/> Left = Decrease; Right = Increase <input type="radio"/> Left = Increase; Right = Decrease
Speed Levels	1
Control Type	1 bit (Decrease/Increase)
Cyclical	<input type="checkbox"/>
Auto Mode	<input type="checkbox"/>
Allow Speed 0	<input type="checkbox"/>

Figure 63. 2-Button Control – Climate - Fan.

- **Action** [Left = Decrease; Right = Increase / Left = Increase; Right = Decrease]: permits setting the increase or decrease actions to one button or another.
- **Speed Levels** [1...5]: sets how many speed levels will be available in the control.
- **Control Type**: sets the type of the communication objects that will control the fan level.
 - [1 bit (decrease/increase)]: orders of speed increase/decrease are sent through the one-bit object “[Pn][Bi] (Climate) Fan Control (1-Bit)”.
 - [Scaling]: scaling values are sent through the one-byte object “[Pn][Bi] (Climate) Fan Control (Scaling)”.
 - [Enumeration]: integer values are sent through the one-byte object “[Pn][Bi] (Climate) Fan Control (Enumeration)”.
- **Cyclical** [disabled/enabled]: sets whether scrolling through the speed levels is circular or not. If checked, an increase order in the maximum level switches to the minimum and vice versa (in the minimum level a decrease order switches to the maximum).
- **Auto Mode** [disabled/enabled]: sets whether the fan Auto mode will be available or not. If checked, the following parameters are also shown.
 - **Dedicated Object for Auto Mode**: sets how the Auto mode should be activated. In the absence of a dedicated object, the Auto fan mode will be activated by switching to fan level 0.

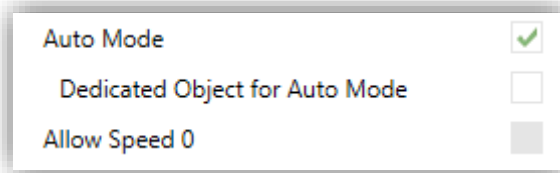

Figure 64. Climate - Fan – Auto mode.

In this case (supposing that Speed Levels has been set to “3”), the fan levels that can be navigated through short presses are:

Auto (0)	Minimum	Medium	Maximum
------------	---------	--------	---------

On the other hand, marking the checkbox enables the 1-bit object “[Pn][Bi] Fan Control – Auto Mode”, which will trigger the **Auto mode** when it receives the corresponding value (**Value to Set Auto Mode** [[Send 0 / Send 1](#)]).

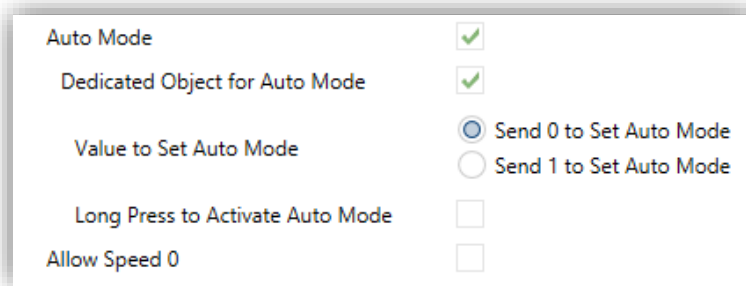

Figure 65. Climate - Fan – Dedicated Object for Auto mode.

However, two alternative (and mutually exclusive) methods are possible to activate this mode:

By short press: Auto mode can be reached as a further level above the maximum one. In this case the fan levels activated by short presses are (note that **speed 0 is optional**):

(0)	Minimum	Medium	Maximum	Auto
-------	---------	--------	---------	------

By long press on any of the buttons of the control (requires checking “**Long Press to Activate Auto Mode**”).

A further long press deactivates back the Auto mode and sends the minimum fan level. Instead, a short press deactivates the Auto mode and switches to the next level (or previous, depending on the button). In this case the fan levels reachable through short presses are (speed 0 is optional):

(0)	Minimum	Medium	Maximum
-------	---------	--------	---------

- **Allow speed 0** [*disabled/enabled*]: sets whether the speed level 0 will be present or not. When the **Auto Mode without a dedicated object** has been configured, this option will be necessarily activated.

3.3.2.4.4 Special Mode

Boxes configured as **Special Mode** controls include two buttons that let the user sequentially commute between the different special climate modes, as well as an icon indicator of the the currently active special mode.

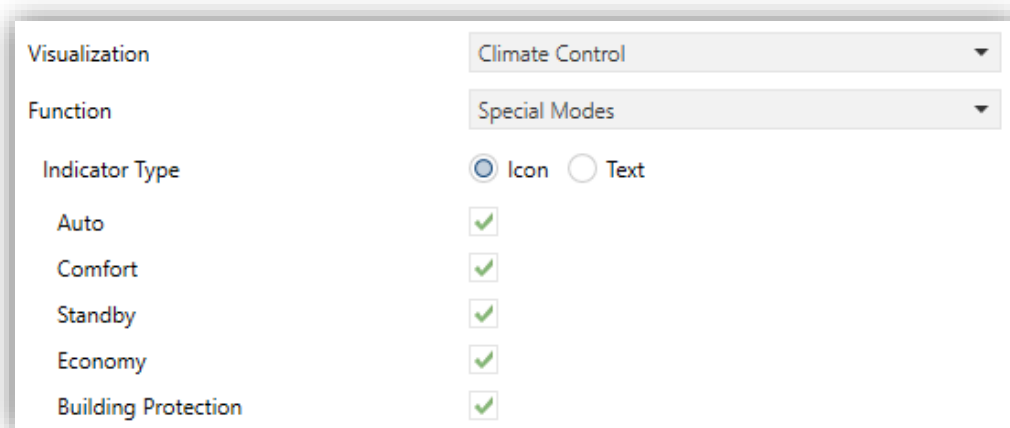

Figure 66. 2-Button Control - Climate - Special Mode.

When this function is assigned to the box, two 1-Byte objects “[Pn][Bi] (Climate) Special Mode Control” and “[Pn][Bi] (Climate) Special Mode Indicator” will be enabled. Through the former object will be sending the bus the value that corresponds to the mode that the user selects by touching the buttons (see Table 7). The box itself will permanently reflect the current value of the control object and/or the corresponding status object. This status object can also receive values from the bus.

If this object receives an unrecognised value from the bus, no icon will be displayed in the indicator.





Special Mode	Icon	Sent Value
Comfort		1 (0x001)
Standby		2 (0x002)
Economy		3 (0x003)
Protection		4 (0x004)
Auto Mode		5 (0x005)

Table 7. Special Modes vs. Icon vs. Object Value.

- **Indicator Type** [[Icon](#) / [Text](#)]: allows selecting whether the status indicator which each value is represented will be text type or icon type. If text type is set, as many text boxes will be displayed as modes have been enabled. The icons are fixed (see Table 7).

3.3.2.5 OTHER CONTROL TYPES

This category involves the following functions, which can be selected through the **Function** parameter:

3.3.2.5.1 RGB Control

This function is intended for sending orders to three-colour LED light regulators, such as Lumento X3 from Zennio.

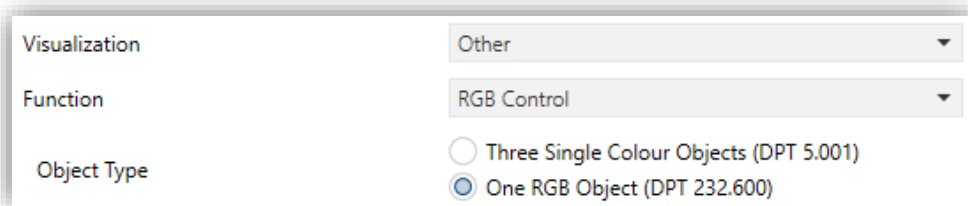

Figure 67. RGB Control.

When the function is assigned to the box, the following parameters come up:

- **Object Type** [[Three Single Colour Objects \(DPT 5.001\)](#) / [One RGB Object \(DPT 232.600\)](#)]: permits selecting what type of object will be used for controlling the light level of the RGB channels.

If “Three Single Colour Objects (DPT 5.001)” is selected, three 1-byte objects will be enabled (with their Write and Read flags activated, so they can both send regulation orders and receive the status from the regulator) named: “[Pn][Bi] **Red Channel**”, “[Pn][Bi] **Green Channel**” and “[Pn][Bi] **Blue Channel**”. Control orders will consist in sending the light level (as a percentage) of the different channels through the corresponding objects.

If “One RGB Object (DPT 232.600)” is selected, only one 3-byte object will be enabled: “[Pn][Bi] **RGB Color**”. In this case, the light levels of the three channels are sent (and received) concatenated into the above 3-byte object.

Note: *if statuses are received while the luminaire performs a regulation, this control may become hardly serviceable until such regulation ends.*

Regarding the RGB control boxes themselves, a central label will permanently show, as a percentage, the current light level (which is determined by the channel with the highest current light level). This **indicator** gets updated automatically as the user interacts with the box, but is also conditioned by the values received from the bus through the already described objects.



Figure 68. RGB Control (Box).

Moreover, two buttons can be found in the box:

- **Short-pressing** on the left button permits commuting between a total absence of light in the three channels, and their respective states previous to the switch-off. **Long-pressing** it, on the other hand, will make the device send a 4-bit dimming order through object “[Pn][Bi] **Light Dimming**”, analogously as the light dimming control.
- The right button, when pressed, launches a pop-up containing a 5x6 **colour palette** that permits the selection of a light level for every channel by touching on any of the pre-set colours.

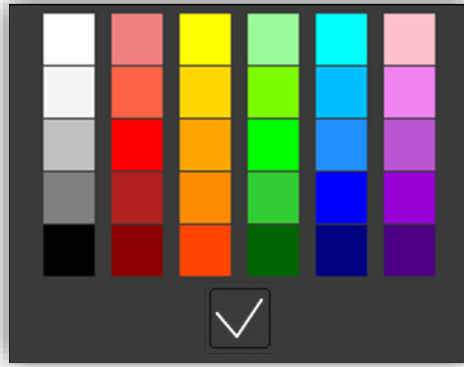

Figure 69. RGB/RGBW Colour Palette

3.3.2.5.2 RGBW Control

The RGBW control is **analogous** to the above RGB control, although it also lets controlling a specific fourth channel for white (“**[Pn][Bi] White Channel**”), in case such feature is supported by the dimmer, as in Lumento X4 from Zennio.

It also has the particularity of being able to choose a colour object.

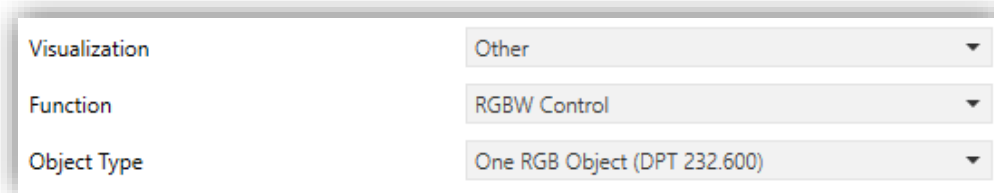

Figure 70. RGBW Control.

- **Object Type** [Three Single Colour Objects (DPT 5.001) / One RGB Object (DPT 232.600) / One RGBW Object (DPT 251.600)]: permits selecting what type of object will be used for controlling the light level of the RGBW channels.

The options “Three Single Colour Objects (DPT 5.001)” and “One RGB Object (DPT 232.600)” are analogous to the RGB control.

If One RGBW Object (DPT 251.600) is selected a 6-bytes object will be enabled: “[Pn][Bi] RGBW Color” through which the light levels of the four channels are sent and received concatenated.

3.3.2.5.3 Daily Timer

Boxes configured as daily timers let the final user program a timed sending of a value to the bus, being possible to send binary or scene values (according to the parameterisation) at a certain time (either every day or only once) or at the end of a countdown. Hence, when the user presses on the box, a window containing the

necessary controls for setting up a timed sending (either at a specific time or after a countdown) will pop up.



Figure 71. Daily Timer Pop up.

This window contains the following elements:

- Timer Type Selector: two-button selector to step through the following options:





			
Timer inactive.	Timer active (every day).	Timer active (no repetition).	Timer active (countdown).

Table 8. Timer Type.

- Time Selector: depending on the selected timer type, permits setting the time for the automated sending, or the length of the countdown.
- Value to be Sent: in case of having parameterised the sending of a binary value, this control lets the user determine the concrete value to be sent (“OFF” or “ON”). In the case of the sending of a scene, this control is not shown, as the scene number is set by parameter.

Hence, at the time set by the user or once the countdown ends, the bus will be automatically sent the corresponding value, through the “[Pn][Bi] Daily Timer Control” object (for binary values) or through the “[General] Scenes: Send” object (in case of scene values).

In both cases the “[Pn][Bi] Daily Timer Enabling” binary object will be available, making it possible to disable (by sending the value “0”) or to enable (value “1”) the

execution of the timed sending set by the user. By default, timed sending is always enabled.

Note:

- In case of disabling a sending through “[Pn][Bi] Daily Timer Enabling”, the corresponding box will show the “forbidden” icon, although the box will not lose the configuration previously set by the user.
- If a download or bus failure has occurred and the time has not yet been set, the active timings configured as “Daily timer” or “Daily timer without repetition” will not be executed. If, once the time has been set, the execution condition of any of the daily timings is restored, the daily timings will be executed.

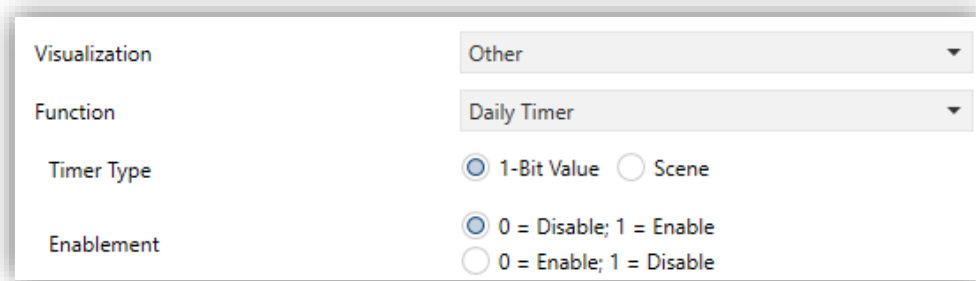

Figure 72. Daily Timer.

- **Timer Type** [[1-Bit Value](#) / [Scene](#)]: allows the user to select how the timer will be controlled.
 - **Scene Number** [[1...64](#)]: shown only after selecting “[Scene](#)” for the above parameter. This field defines the number of the scene that will be sent to the bus on the execution of the timed sending.
- **Enablement** [[0 = Disable; 1 = Enable](#) / [0 = Enable; 1 = Disable](#)]: sets the value to enable and disable the timer through the object “[Pn][Bi] Daily Timer Enabling”.

3.3.2.5.4 Weekly Timer

Boxes configured as weekly timers let the final user program a timed sending of a binary or scene value to the bus (according to the parameterisation) at a certain time on certain days (on a weekly basis).

The difference between the daily and the weekly timers is that the latter does not permit the countdown-based sending, although it does permit that a time-based sending takes place every week, on the days selected by the user

Hence, when the user presses on the box, a window similar to Figure 73 will pop up.



Figure 73. Weekly Timer Pop-up.

This window contains the following elements:

- **Day Selector:** lets the user select the days the timed sending will take place on. The first day of the week depends on the parameterisation of the GENERAL tab (see section 3.1.1).
 - **Value to be Sent (ON / OFF):** lets the user set the value to be sent. It can be “ON” or “OFF”, or even both at different times. Once selector is provided for each of the two values.
- Note:** if instead of the sending of a binary value, the sending of a scene value has been parameterised, only one checkbox and once selector will be shown, so the user can enable/disable the sending of the scene value and, if enabled, set the desired time.
- **Time Selector:** let the user set the time at which the automatic sending will take place.

Hence, at the specified time on the days selected by the user, the bus will be automatically sent the corresponding value through the “[Pn][Bi] Weekly Timer Control” object (in the case of sending a binary value) or through the “[General] Scenes: Send” object (in the case of sending a scene number).

In both cases the “[Pn][Bi] Weekly Timer Enabling” binary object will be available, making it possible to disable (by sending the value “0”) or to enable (value “1”) the execution of the timings set by the user. By default, user timings are always enabled.

Note:

- In case of disabling a sending through “[Pn][Bi] Weekly Timer Enabling”, the corresponding box will show the “forbidden” icon, although the box will not lose the configuration previously set by the user.
- If a download or bus failure has occurred and the time has not yet been set, the active weekly timings will not be executed. If, once the time has been set, the execution condition of any of the weekly timings is restored, the weekly timings will be executed.

Figure 74. Weekly Timer.

This function offers the following parameters in ETS:

- **Timer Type:** [[1-Bit Value](#) / [Scene](#)]: allows the user to select how the timer will be controlled.
- **Scene Number** [[1...64](#)]: shown only after selecting “[Scene](#)” for the above parameter. This field defines the number of the scene that will be sent to the bus on the execution of the timed sending.
- **Label for “Scene”** [[Scene](#)]: permits customising the label shown next to the checkbox that enables/disables the scene sending.
- **Label for “Time ON”** [[Time ON](#)]: permits customising the label shown next to the checkbox that enables/disables the sending of the switch-on order.

- **Label for “Time OFF”** [[Time OFF](#)]: permits customising the label shown next to the checkbox that enables/disables the sending of the switch-off order.
- **Enablement** [[0 = Disable; 1 = Enable / 0 = Enable; 1 = Disable](#)]: sets the value to enable and disable the timer through the object “[Pn][Bi] Weekly Timer Enabling”.

Note: *the execution of user-defined timers is triggered on the detection of state transitions, even if the clock does not specifically pass through the specified time. In other words, supposing one timed sending of the value “ON” at 10:00h am and one timed sending of the value “OFF” at 8:00h pm, if the internal clock is set to 9:00h pm just after 10:00h am (and therefore after having sent the value “ON”), then the “OFF” order corresponding to 8:00h pm will take place immediately after the time change.*

3.3.2.5.5 Alarm

Boxes configured as alarms perform user warnings on anomalous events. For this purpose, boxes of this type are related to the binary object “[Pn][Bi] Alarm Trigger” that permits receiving alarm messages from the bus, thus making Z40 emit a continuous beep while the screen light blinks. In addition, the screen will automatically browse to the page containing the alarm box that has been triggered. Any pop-up, message or function that has been activated will be deactivated and the alarm will be given priority.

The **blinking warning icon** shows that the alarm is active and not confirmed. This icon will also appear in the lower right corner of the button of the page where the alarm is located.

When an alarm has been activated, there are two different ways to silence the sound notification and the luminous blinking of the display.

- **Pressing the ‘Home’ button:** it will silence the sound notification and end the flashing, but it will not confirm the alarm. The alarm box icon will continue blinking.
- **Press the ‘OK’ button in the alarm box:** this will silence the sound notification, end the flashing light, confirm the alarm, and cause the icon to stop blinking. When this button is pressed, the binary object “[Pn] [Bi] Alarm Confirmation” with the value “1” will be sent through the bus. If this object receives from the bus the value “1”, the alarm will also be confirmed, having the same effects.

The alarm will definitely become inactive once it has been confirmed and, in addition, once the “[Pn][Bi] Alarm Trigger” object goes back to the “no alarm” state (the order

of these two events is irrelevant), after which the box icon and the page icon will finally turn off.

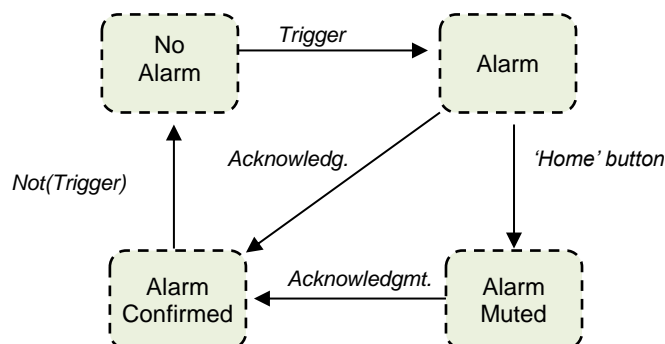

Figure 75. Alarm state diagram (case of confirmation previous to the alarm end).

There is also the possibility of **periodically monitoring** the status of the trigger object, for situations where this object is periodically received from the bus. This will let Z40 automatically assume the alarm situation if the “no alarm” value does not get sent through the trigger object after a certain time, for example upon failures of the transmitter. The maximum time window can be defined by parameter.

Consequently, alarm boxes permit configuring the following parameters:

Visualization	Other
Function	Alarm
Trigger	<input type="radio"/> 0 <input checked="" type="radio"/> 1
Periodic monitoring	<input checked="" type="radio"/> No <input type="radio"/> Yes
Protect	<input checked="" type="radio"/> No <input type="radio"/> Yes

Figure 76. Alarm.

- **Trigger** [1/0]: defines the value that will trigger the alarm (“0” or “1”; it is “1” by default), i.e., the value that, when received through “[Pn][Bi] Alarm Trigger”, should be interpreted by Z40 as an alarm situation. Implicitly, this parameter also defines the inverse “no alarm” value.
- **Periodic Monitoring** [No / Yes]: activates or deactivates periodic monitoring of the alarm trigger object. When activated, the following parameter appears:
 - **Cycle Time** [30...65535][s] [1...65535][min/h]: sets the maximum accepted time space without receiving the “no alarm” value before Z40 adopts the alarm situation.

Example I: *supposing a certain sensor responsible for sending the value “1” (once) to the bus when a flood is detected, and the value “0” (again, only once) when such situation terminates, if the object sent is linked to the alarm trigger object from an alarm box in Z40 where no periodical monitoring has been parameterised and where the value “1” has been set as the alarm value, then Z40 will notify an emergency every time a flood takes place. The notification will stop as soon as the user touches any button, although a warning icon will still blink on the screen. After that, if the user acknowledges the alarm, the icon will stop blinking; switching then off once the sensor sends a “0”.*

Example II: *suppose a certain CO₂ sensor responsible for sending the value “0” to the bus every two minutes, except when it detects a dangerous CO₂ level; in such case, it will immediately send the value “1”. If the object being sent is linked to the alarm trigger object from an alarm box in Z40 where periodic monitoring has been parameterised and where the value “1” is configured as the alarm trigger value, then Z40 will notify the user about the emergency both if the CO₂ level reaches a dangerous level and if the sensor stops sending the value “0”, for example due to failures or sabotage. The user should proceed in the same manner as in the above example to manage the alarm notification.*

3.3.2.5.6 Page Direct Link

This control allows one or two shortcuts to the pages indicated by parameter. To configure a box as a page direct link type control, the page to be accessed and the icon and color of the button must be set.

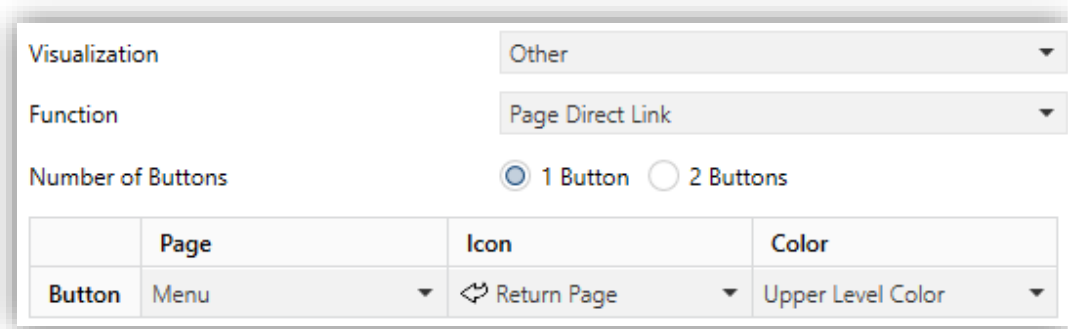
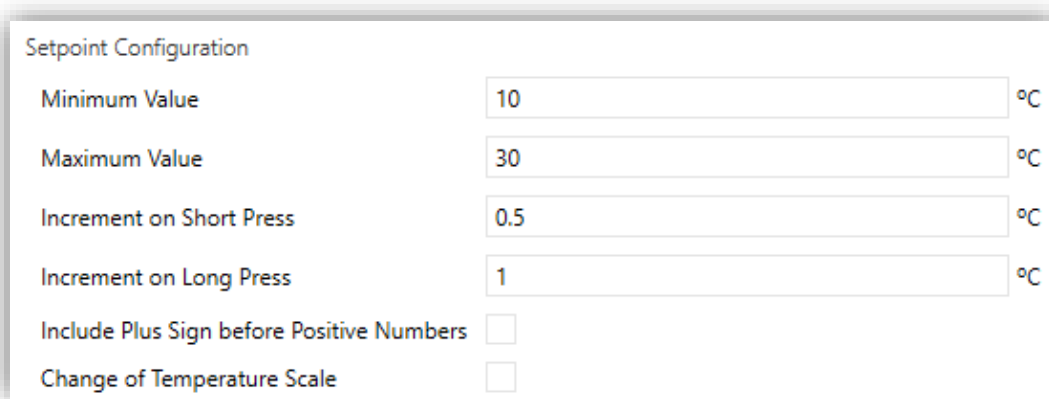

Figure 77. Page Direct Link.

- **Number of buttons** [[1 Button](#) / [2 Buttons](#)]: allows setting one or two page direct links.
- **Page** [[Menu](#) / [Configuration](#) / [Page 1](#) / ... / [Page 12](#)]: page that will be accessed.

3.3.3 SETPOINT

Pages configured as a thermostat will have a larger central box (always enabled) with two buttons **for controlling the temperature of an external thermostat** through the communication objects enabled to that effect: "[Pn][Setpoint] Temperature Setpoint" for the control and "[Pn][Setpoint] Temperature Indicator" for the status.



The screenshot shows a 'Setpoint Configuration' dialog box with the following fields and options:

Parameter	Value	Unit
Minimum Value	10	°C
Maximum Value	30	°C
Increment on Short Press	0.5	°C
Increment on Long Press	1	°C
Include Plus Sign before Positive Numbers	<input type="checkbox"/>	
Change of Temperature Scale	<input type="checkbox"/>	

Figure 78. Setpoint Control.

This control has the same parameters as the normal setpoint control (section 3.3.2.4.1) with the following additional options:

- **Change of Temperature Scale** [*disabled/enabled*]: replaces the unit indicator with a button/indicator that permits changing the scale of the temperatures shown on the screen. One press on the button/indicator toggles between Celsius scale and Fahrenheit scale.

3.3.4 FAN

This control consists of several boxes in vertical arrangement **for controlling the fan speed**. The number of boxes depends on the speed levels selected and whether the auto mode is enabled.

When this box is enabled, the control object "[Pn][Fan] Fan Control (Type: Scaling)" as well as the "[Pn][Fan] Fan Indicator" 1-byte status object appear. The status object (which needs to be linked to the status object of the fan actuator) will express, as a percentage, the value of the current fan level, which will be represented with a variable icon on the box.



Figure 79. Fan Control.

- **Speed Levels** [2/3]: sets how many speed levels will be available in the control.
- **Auto Mode** [*disabled/enabled*]: sets whether the fan Auto mode will be available or not. If checked, the Auto fan mode will be activated by switching to fan level 0 and the following parameter shows up:
 - **Dedicated Object for Auto Mode**: marking the checkbox enables the 1-bit object “[Pn][Bi] Fan Control – Auto Mode”, which will trigger the **Auto mode** when it receives the corresponding value (**Value to Set Auto Mode** [*Send 0 / Send 1*]) and an arrow will be displayed next to the AUTO icon (as well as next to the currently activated speed).

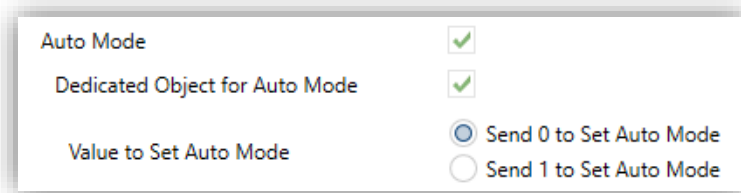

Figure 80. Fan – Dedicated Object for Auto Mode.

3.4 CONFIGURATION PAGE

The Configuration page lets the user to know or adjust certain technical details about the device, as well as to configure the visual and sound settings.

The integrator has previously had to enable this page on the "MENU" page.

ETS PARAMETERISATION

After enabling the **Configuration Page** from "Configuration" screen under Menu (see section 3.1.1), a new tab will be incorporated into the tree on the left.

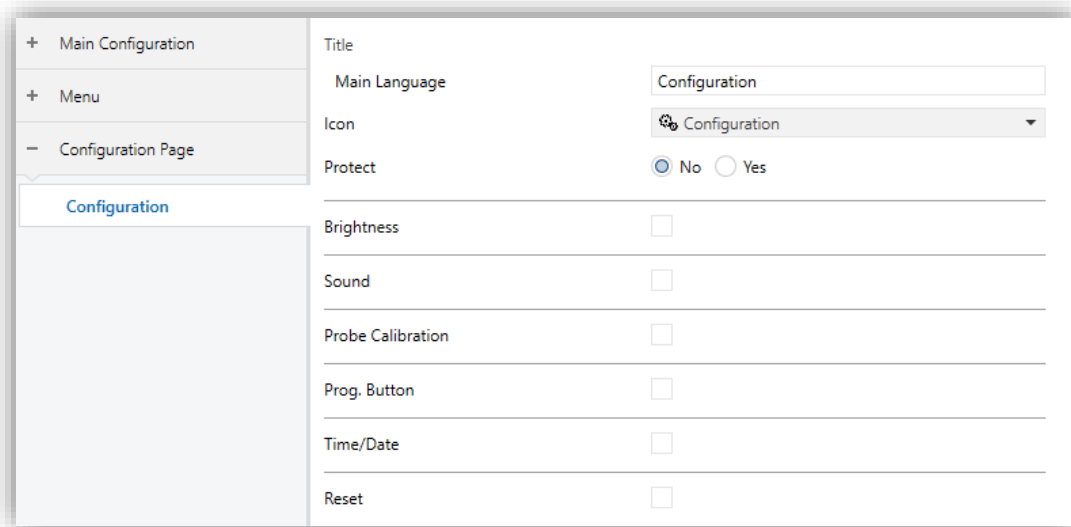

Figure 81. Configuration Page.

The parameters of the page itself are:

- **Title:**
 - **Language X [[Configuration](#)]:** text field that defines the title that will be shown on the top of the Configuration page for the corresponding language.
- **Icon [[Configuration](#)]:** sets the icon that will represent the page in the Menu page.
- **Protect:** sets whether the page will be password-protected or not. Depending on the security levels configured (one or two; see section 3.1.4) this list will contain the following options:
 - **One Level:**
 - [\[No\]](#): the page will not be protected by password. All users can access it.

[Yes]: the page will be protected by password. Users will be asked to type the password when trying to access it.

➤ **Two Levels:**

[No]: the page will not be protected by password. All users can access it.

[Level 1]: the page will implement security level 1. To access it, users will be required to enter password 1 or password 2.

[Level 2]: the page will implement security level 2. To access it, users will be required to enter password 2.

In addition, the specific controls that can be enabled for the Configuration page are:

- **Brightness** [*disabled/enabled*]: enables or disables the box to adjust the brightness of the display. In addition, the following settings can be configured:
- **Sound** [*disabled/enabled*]: enables or disables the box to deactivate/activate the device sounds.
- **Probe Calibration** [*disabled/enabled*]: enables or disables the box to configure the offset of the internal temperature probe.
- **Prog. Button** [*disabled/enabled*]: enables or disables the control/indicator that shows the status of the Prog./Test LED of the device. In particular, it permits entering/leaving the programming mode as by pressing the actual programming button of the device (see 1.3).
- **Time/Date** [*disabled/enabled*]: enables or disables the box to configure Z40 time and date.

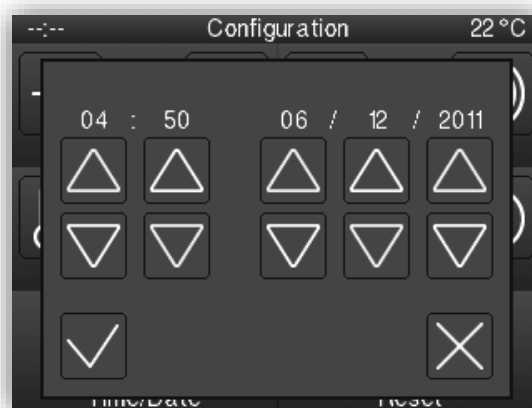

Figure 82. Time and Date pop-up.

- **Reset** [[disabled/enabled](#)]: enables or disables the box to perform a reset on the device, by pressing more than 3 seconds the button:
 - **Reset Type** [[Parameters Reset/Z40 Reboof](#)]: sets the reset type required:
 - [[Parameters Reset](#)]: similar to restoring the device to the just-parameterised state, with the subsequent reset of the object values, alarm controls, timers, etc.
 - [[Z40 Reboof](#)]: simple device reset, with no data loss.

Moreover, for all these controls, the following parameters can be configured:

- **Label** [[Brightness](#)]: text that will appear to identify the box. Again, new parameters will appear if several translations get enabled.
- **Protection** [[No/Yes](#)] / [[No/Level 1/Level 2](#)]: exactly the same as the page protection explained above. In this case, the user can enable the protection of the box.
- **Object to Show/Hide de Box** [[disabled/enabled](#)]: When this option is enabled, a new 1 bit object appears (“**[Config.][Bi] Show/Hide Box**”) that allows hiding / displaying the box through the KNX bus.

3.5 INPUTS

Z40 incorporates **four analogue/digital inputs**, each configurable as a:

- **Binary Input**, for the connection of a pushbutton or a switch/sensor.
- **Temperature Probe**, to connect a temperature from Zennio.
- **Motion Detector**, to connect a motion detector from Zennio.

3.5.1 BINARY INPUT

Please refer to the specific user manual “**Binary Inputs**”, available in the Z40 product section, at the Zennio website (www.zennio.com).

3.5.2 TEMPERATURE PROBE

Please refer to the specific user manual “**Temperature Probe**”, available in the Z40 product section, at the Zennio website (www.zennio.com).

3.5.3 MOTION DETECTOR

It is possible to connect motion detectors from Zennio to the input ports of Z40. This brings the device with the possibility of monitoring motion and presence in the room. Depending on the detection, different response actions can be parameterised.

Please refer to the specific “**Motion Detector**” user manual (available in the Z40 product section at the Zennio website, www.zennio.com) for detailed information about the functionality and the configuration of the related parameters.

3.6 THERMOSTAT

Z40 implements **two Zennio thermostats** which can be enabled and fully customised.

Please refer to the specific manual “**Zennio Thermostat**” (available in the Z40 product section at the Zennio website, www.zennio.com) for detailed information about the functionality and the configuration of the related parameters.

ANNEX I. COMMUNICATION OBJECTS

- “Functional range” shows the values that, with independence of any other values permitted by the bus according to the object size, may be of any use or have a particular meaning because of the specifications or restrictions from both the KNX standard or the application program itself.

Number	Size	I/O	Flags	Data type (DPT)	Functional Range	Name	Function
1	1 Bit		C - - T -	DPT_Trigger	0/1	[Heartbeat] Object to Send '1'	Sending of '1' Periodically
2	3 Bytes	I	C - W T U	DPT_TimeOfDay	00:00:00 - 23:59:59	[General] Time of Day	Time of Day External Reference
3	3 Bytes	I	C - W T U	DPT_Date	01/01/1990 - 31/12/2089	[General] Date	Date External Reference
4	1 Byte	I	C - W - -	DPT_SceneNumber	0 - 63	[General] Scene: Receive	0-63 (Run Scene 1-64)
5	1 Byte		C - - T -	DPT_SceneControl	0-63; 128-191	[General] Scene: Send	0-63 / 128-191 (Run/Save Scene 1-64)
6	1 Bit	I	C - W - -	DPT_State	0/1	[General] Activity	0 = Inactivity; 1 = Activity
7	1 Bit	I	C - W T U	DPT_Enable	0/1	[General] Touch Locking	0 = Unlock; 1 = Lock
	1 Bit	I	C - W T U	DPT_Enable	0/1	[General] Touch Locking	0 = Lock; 1 = Unlock
8	1 Bit	I	C - W - -	DPT_Ack	0/1	[General] Cleaning Function	0 = Nothing; 1 = Clean Now
9	2 Bytes	I	C - W T U	DPT_Value_Temp	-273.00° - 670433.28°	[General] External Temperature	Temperature to Be Shown
10, 16, 22, 28, 34, 40	1 Bit	I	C - W - -	DPT_Switch	0/1	[General][Pop-Up x] 1-Bit	0 = Hide Pop-Up; 1 = Show Pop-Up
	1 Bit	I	C - W - -	DPT_Switch	0/1	[General][Pop-Up x] 1-Bit	0 = Show Pop-Up; 1 = Hide Pop-Up
11, 17, 23, 29, 35, 41	1 Byte	I	C - W - -	DPT_Value_1_Ucount	0 - 255	[General][Pop-Up x] 1-Byte	Hide/Show Pop-Up
12, 13, 14, 15, 18, 19, 20, 21, 24, 25, 26, 27, 30, 31, 32, 33, 36, 37, 38, 39, 42, 43, 44, 45	14 Bytes	I	C - W - -	DPT_String_UTF-8		[General][Pop-Up x] Line x	Text to Show on the Display at Line x
46	1 Byte	I	C - W - -	DPT_Language_Selection	0 - 255	[General] Translations - Select Language	0 = Main; 1 = Lang. 2; ...; 4 = Lang. 5
47	1 Bit	I	C - W - -	DPT_Ack	0/1	[General] Translations - Main Language	0 = Nothing; 1 = Choose this Language
48, 49, 50, 51	1 Bit	I	C - W - -	DPT_Ack	0/1	[General] Translations - Language x	0 = Nothing; 1 = Choose this Language
52	2 Bytes	I	C - W - -	DPT_LanguageCodeAlpha2_ASCII		[General] Translations - Select Language	Language Selection Through ISO 639-1 Two Letters Code
53	1 Bit	I	C - W T U	DPT_Enable	0/1	[General] Sounds - Disabling Button Sound	0 = Disable Sound; 1 = Enable Sound

	1 Bit	I	C - W T U	DPT_Enable	0/1	[General] Sounds - Disabling Button Sound	0 = Enable Sound; 1 = Disable Sound
54	1 Bit	I	C - W - -	DPT_Ack	0/1	[General] Sounds - Doorbell	0 = Nothing; 1 = Play Doorbell Sound
	1 Bit	I	C - W - -	DPT_Ack	0/1	[General] Sounds - Doorbell	0 = Play Doorbell Sound; 1 = Nothing
55	1 Bit	O	C R - T -	DPT_Switch	0/1	[General] Welcome Back Object	Switch Object Sent on Wake Up
56, 57, 58, 59, 60	1 Bit	I	C - W - -	DPT_Switch	0/1	[General] Welcome Back Object - Additional Condition	Additional Condition Object x
61	1 Bit	I	C - W T U	DPT_Switch	0/1	[General] Temperature Scale	0 = °C; 1 = °F
62, 63, 64, 65, 66, 67	1 Bit	I	C - W - -	DPT_Switch	0/1	[Config.][Bx] Show/Hide Box	0 = Hide Box; 1 = Show Box
68, 83, 98, 113, 128, 143, 158, 173, 188, 203, 218, 233, 248, 263, 278, 293, 308, 323, 338, 353, 368, 383, 398, 413, 428, 443, 458, 473, 488, 503, 518, 533, 548, 563, 578, 593, 608, 623, 638, 653, 668, 683, 698, 713, 728, 743, 758, 773, 788, 803, 818, 833, 848, 863, 878, 893	1 Bit	I	C - W - -	DPT_Switch	0/1	[Px][Bx] Show/Hide Box	0 = Hide Box; 1 = Show Box
	1 Bit	I	C - W - -	DPT_Switch	0/1	[Px][Fan] Show/Hide Box	0 = Hide Box; 1 = Show Box
	1 Bit	I	C - W - -	DPT_Switch	0/1	[Px][Setpoint] Show/Hide Box	0 = Hide Box; 1 = Show Box
69, 84, 99, 114, 129, 144, 159, 174, 189, 204, 219, 234, 249, 264, 279, 294, 309, 324, 339, 354, 369, 384, 399, 414, 429, 444, 459, 474, 489, 504, 519, 534, 549, 564, 579, 594, 609, 624, 639, 654, 669, 684, 699, 714, 729, 744, 759, 774, 789, 804, 819, 834, 849, 864, 879, 894	1 Bit	O	C R - T -	DPT_Switch	0/1	[Px][Bx] Switch: "0"	1-Bit Generic Control
	1 Bit	O	C R - T -	DPT_Switch	0/1	[Px][Bx] Switch: "1"	1-Bit Generic Control
	1 Bit	O	C R - T -	DPT_Switch	0/1	[Px][Bx] Switch: "0/1"	1-Bit Generic Control
	1 Bit	O	C R - T -	DPT_Switch	0/1	[Px][Bx] Hold & Release	1-Bit Generic Control
	1 Bit	O	C R - T -	DPT_Switch	0/1	[Px][Bx] Two Objects - Short Press: "1"	1-Bit Generic Control
	1 Bit	O	C R - T -	DPT_Switch	0/1	[Px][Bx] Two Objects - Short Press: "0"	1-Bit Generic Control
	1 Bit	I/O	C R W T U	DPT_Switch	0/1	[Px][Bx] Two Objects - Short Press: "0/1"	1-Bit Generic Control
	1 Bit	O	C R - T -	DPT_Switch	0/1	[Px][Bx] Switch	1-Bit Generic Control
	1 Bit	O	C R - T -	DPT_Switch	0/1	[Px][Bx] Light - On/Off	0 = Off; 1 = On
	1 Bit	O	C R - T -	DPT_UpDown	0/1	[Px][Bx] Shutter - Move	0 = Up; 1 = Down
	1 Bit	O	C R - T -	DPT_Switch	0/1	[Px][Bx] Two Objects - Short Press	1-Bit Generic Control
	1 Bit	O	C R - T -	DPT_Heat_Cool	0/1	[Px][Bx] (Climate) Mode Control	0 = Cool; 1 = Heat
	1 Bit	O	C R - T -	DPT_Step	0/1	[Px][Bx] (Climate) Fan Control (1-Bit)	0 = Decrease; 1 = Increase
	1 Bit	I	C - W T U	DPT_Enable	0/1	[Px][Bx] Daily Timer Enabling	0 = Disable; 1 = Enable
	1 Bit	I	C - W T U	DPT_Enable	0/1	[Px][Bx] Daily Timer Enabling	0 = Enable; 1 = Disable
1 Bit	I	C - W T U	DPT_Enable	0/1	[Px][Bx] Weekly Timer Enabling	0 = Disable; 1 = Enable	

	1 Bit	I	C - W T U	DPT_Enable	0/1	[Px][Bx] Weekly Timer Enabling	0 = Enable; 1 = Disable
	1 Bit	I	C - W - U	DPT_Alarm	0/1	[Px][Bx] Alarm Trigger	Trigger: 0
	1 Bit	O	C R - T -	DPT_Switch	0/1	[Px][Bx] Multimedia	0 = Stop/Backward; 1 = Start/Forward
	1 Bit	I	C - W - U	DPT_Alarm	0/1	[Px][Bx] Alarm Trigger	Trigger: 1
	1 Bit	I/O	CRWTU	DPT_Alarm	0/1	[Px] Alarm	0 = No alarm; 1 = Alarm
	1 Bit	I/O	CRWTU	DPT_Alarm	0/1	[Px] Alarm	0 = Alarm; 1 = No alarm
70, 85, 100, 115, 130, 145, 160, 175, 190, 205, 220, 235, 250, 265, 280, 295, 310, 325, 340, 355, 370, 385, 400, 415, 430, 445, 460, 475, 490, 505, 520, 535, 550, 565, 580, 595, 610, 625, 640, 655, 670, 685, 700, 715, 730, 745, 760, 775, 790, 805, 820, 835, 850, 865, 880, 895	1 Bit	O	C R - T -	DPT_Switch	0/1	[Px][Bx] Two Objects - Long Press: "1"	1-Bit Generic Control
	1 Bit	O	C R - T -	DPT_Switch	0/1	[Px][Bx] Two Objects - Long Press: "0"	1-Bit Generic Control
	1 Bit	O	C R - T -	DPT_Switch	0/1	[Px][Bx] Two Objects - Long Press: "0/1"	1-Bit Generic Control
	1 Bit	O	C R - T -	DPT_Step	0/1	[Px][Bx] Shutter - Stop/Step	0 = Stop/Step Up; 1 = Stop/Step Down
	1 Bit	O	C R - T -	DPT_Switch	0/1	[Px][Bx] Two Objects - Long Press	1-Bit Generic Control
	1 Bit	I/O	CRWTU	DPT_Switch	0/1	[Px][Bx] (Climate) Fan Control - Auto Mode	Switch Auto Mode on Short Press
	1 Bit	I/O	CRWTU	DPT_Switch	0/1	[Px][Bx] (Climate) Fan Control - Auto Mode	Switch Auto Mode on Long Press
	1 Bit	O	C R - T -	DPT_Switch	0/1	[Px][Bx] Daily Timer Control	1-Bit Generic Control
	1 Bit	O	C R - T -	DPT_Switch	0/1	[Px][Bx] Weekly Timer Control	1-Bit Generic Control
	1 Bit	I	C - W T U	DPT_Ack	0/1	[Px][Bx] Alarm Confirmation	0 = No Action; 1 = Confirm
	1 Bit	I	C - W - -	DPT_Enable	0/1	[Px] Enable Alarm	According to parameters
1 Bit	I/O	CRWTU	DPT_Switch	0/1	[Px][Fan] Fan Control - Auto Mode	Switch Auto Mode on Short Press	
71, 86, 101, 116, 131, 146, 161, 176, 191, 206, 221, 236, 251, 266, 281, 296, 311, 326, 341, 356, 371, 386, 401, 416, 431, 446, 461, 476, 491, 506, 521, 536, 551, 566, 581, 596, 611, 626, 641, 656, 671, 686, 701, 716, 731, 746, 761, 776, 791, 806, 821, 836, 851, 866, 881, 896	4 Bit	O	C R - T -	DPT_Control_Dimming	0x0 (Stop) 0x1 (Dec. by 100%) ... 0x7 (Dec. by 1%) 0x8 (Stop) 0xD (Inc. by 100%) ... 0xF (Inc. by 1%)	[Px][Bx] Light - Dimming	4-Bit Dimming Control
72, 87, 102, 117, 132, 147, 162, 177, 192, 207, 222, 237, 252, 267, 282, 297, 312, 327, 342, 357, 372, 387, 402, 417, 432, 447, 462, 477, 492, 507,	3 Bytes	I/O	CRWTU	DPT_Colour_RGB	[0 - 255] * 3	[Px][Bx] RGB Color	Red, Green and Blue Components

522, 537, 552, 567, 582, 597, 612, 627, 642, 657, 672, 687, 702, 717, 732, 747, 762, 777, 792, 807, 822, 837, 852, 867, 882, 897							
73, 88, 103, 118, 133, 148, 163, 178, 193, 208, 223, 238, 253, 268, 283, 298, 313, 328, 343, 358, 373, 388, 403, 418, 433, 448, 463, 478, 493, 508, 523, 538, 553, 568, 583, 598, 613, 628, 643, 658, 673, 688, 703, 718, 733, 748, 763, 778, 793, 808, 823, 838, 853, 868, 883, 898	1 Byte	O	CR-T-	DPT_Value_1_Ucount	0 - 255	[Px][Bx] 1-Byte Unsigned Int Control	0 ... 255
	1 Byte	O	CR-T-	DPT_Value_1_Count	-128 - 127	[Px][Bx] 1-Byte Signed Int Control	-128 ... 127
	1 Byte	O	CR-T-	DPT_Value_1_Ucount	0 - 255	[Px][Bx] Two Objects - Short Press: (1-Byte)	Send Selected 1-Byte Value on Short Press
	1 Byte	O	CR-T-	DPT_Scaling	0% - 100%	[Px][Bx] Percentage Control	0% ... 100%
	1 Byte	O	CR-T-	DPT_HVACContrMode	0=Auto 1=Heat 3=Cool 9=Fan 14=Dry	[Px][Bx] (Climate) Mode Control	Auto, Heat, Cool, Fan and Dry
	1 Byte	O	CR-T-	DPT_Scaling	0% - 100%	[Px][Bx] (Climate) Fan Control (Scaling)	100%
	1 Byte	O	CR-T-	DPT_Scaling	0% - 100%	[Px][Bx] (Climate) Fan Control (Scaling)	50%, 100%
	1 Byte	O	CR-T-	DPT_Scaling	0% - 100%	[Px][Bx] (Climate) Fan Control (Scaling)	33%, 67%, 100%
	1 Byte	O	CR-T-	DPT_Scaling	0% - 100%	[Px][Bx] (Climate) Fan Control (Scaling)	25%, 50%, 75%, 100%
	1 Byte	O	CR-T-	DPT_Scaling	0% - 100%	[Px][Bx] (Climate) Fan Control (Scaling)	20%, 40%, 60%, 80%, 100%
	1 Byte	O	CR-T-	DPT_Fan_Stage	0 - 255	[Px][Bx] (Climate) Fan Control (Enumeration)	1
	1 Byte	O	CR-T-	DPT_Fan_Stage	0 - 255	[Px][Bx] (Climate) Fan Control (Enumeration)	1, 2
	1 Byte	O	CR-T-	DPT_Fan_Stage	0 - 255	[Px][Bx] (Climate) Fan Control (Enumeration)	1, 2, 3
	1 Byte	O	CR-T-	DPT_Fan_Stage	0 - 255	[Px][Bx] (Climate) Fan Control (Enumeration)	1, 2, 3, 4
	1 Byte	O	CR-T-	DPT_Fan_Stage	0 - 255	[Px][Bx] (Climate) Fan Control (Enumeration)	1, 2, 3, 4, 5
	1 Byte	I/O	CRWTU	DPT_Scaling	0% - 100%	[Px][Bx] Red Channel	0% ... 100%
1 Byte	O	CR-T-	DPT_HVACMode	1=Comfort 2=Standby 3=Economy 4=Building Protection	[Px][Bx] (Climate) Special Mode Control	Auto, Comfort, Standby, Economy, Building Protection	
1 Byte	O	CR-T-	DPT_Value_1_Ucount	0 - 255	[Px][Bx] Enumeration Control	Rotating value change	

1 Byte	O	CR-T-	DPT_Fan_Stage	0 - 255	[Px][Bx] (Climate) Fan Control (Enumeration)	0, 1
1 Byte	O	CR-T-	DPT_Fan_Stage	0 - 255	[Px][Bx] (Climate) Fan Control (Enumeration)	0, 1, 2, 3, 4, 5
1 Byte	O	CR-T-	DPT_Fan_Stage	0 - 255	[Px][Bx] (Climate) Fan Control (Enumeration)	0, 1, 2, 3, 4
1 Byte	O	CR-T-	DPT_Fan_Stage	0 - 255	[Px][Bx] (Climate) Fan Control (Enumeration)	0, 1, 2, 3
1 Byte	O	CR-T-	DPT_Fan_Stage	0 - 255	[Px][Bx] (Climate) Fan Control (Enumeration)	0, 1, 2
1 Byte	O	CR-T-	DPT_Scaling	0% - 100%	[Px][Bx] (Climate) Fan Control (Scaling)	0%, 20%, 40%, 60%, 80%, 100%
1 Byte	O	CR-T-	DPT_Scaling	0% - 100%	[Px][Bx] (Climate) Fan Control (Scaling)	0%, 33%, 67%, 100%
1 Byte	O	CR-T-	DPT_Scaling	0% - 100%	[Px][Bx] (Climate) Fan Control (Scaling)	0%, 50%, 100%
1 Byte	O	CR-T-	DPT_Scaling	0% - 100%	[Px][Bx] (Climate) Fan Control (Scaling)	0%, 100%
1 Byte	O	CR-T-	DPT_Scaling	0% - 100%	[Px][Bx] (Climate) Fan Control (Scaling)	0%, 25%, 50%, 75%, 100%
1 Byte	O	CR-T-	DPT_Scaling	0% - 100%	[Px][Bx] (Climate) Fan Control (Scaling)	Auto, 100%
1 Byte	O	CR-T-	DPT_Scaling	0% - 100%	[Px][Bx] (Climate) Fan Control (Scaling)	Auto, 20%, 40%, 60%, 80%, 100%
1 Byte	O	CR-T-	DPT_Scaling	0% - 100%	[Px][Bx] (Climate) Fan Control (Scaling)	Auto, 25%, 50%, 75%, 100%
1 Byte	O	CR-T-	DPT_Scaling	0% - 100%	[Px][Bx] (Climate) Fan Control (Scaling)	Auto, 33%, 67%, 100%
1 Byte	O	CR-T-	DPT_Scaling	0% - 100%	[Px][Bx] (Climate) Fan Control (Scaling)	Auto, 50%, 100%
1 Byte	O	CR-T-	DPT_Fan_Stage	0 - 255	[Px][Bx] (Climate) Fan Control (Enumeration)	Auto, 1
1 Byte	O	CR-T-	DPT_Fan_Stage	0 - 255	[Px][Bx] (Climate) Fan Control (Enumeration)	Auto, 1, 2
1 Byte	O	CR-T-	DPT_Fan_Stage	0 - 255	[Px][Bx] (Climate) Fan Control (Enumeration)	Auto, 1, 2, 3
1 Byte	O	CR-T-	DPT_Fan_Stage	0 - 255	[Px][Bx] (Climate) Fan Control (Enumeration)	Auto, 1, 2, 3, 4
1 Byte	O	CR-T-	DPT_Fan_Stage	0 - 255	[Px][Bx] (Climate) Fan Control (Enumeration)	Auto, 1, 2, 3, 4, 5
1 Byte		C--T-	DPT_SceneNumber	0 - 63	[Px][Bx] Scene: Send	0-63 (Run Scene 1-64)
1 Byte		C--T-	DPT_SceneControl	0-63; 128-191	[Px][Bx] Scene: Send	0-63 / 128-191 (Run/Save Scene 1-64)

	1 Byte	O	CR-T-	DPT_Scaling	0% - 100%	[Px][Fan] Fan Control (Type: Scaling)	Auto, 50%, 100%
	1 Byte	O	CR-T-	DPT_Scaling	0% - 100%	[Px][Fan] Fan Control (Type: Scaling)	0%, 50%, 100%
	1 Byte	O	CR-T-	DPT_Scaling	0% - 100%	[Px][Fan] Fan Control (Type: Scaling)	Auto, 33%, 67%, 100%
	1 Byte	O	CR-T-	DPT_Scaling	0% - 100%	[Px][Fan] Fan Control (Type: Scaling)	0%, 33%, 67%, 100%
	1 Byte	O	CR-T-	DPT_Scaling	0% - 100%	[Px][Fan] Fan Control (Type: Scaling)	33%, 67%, 100%
	1 Byte	O	CR-T-	DPT_Scaling	0% - 100%	[Px][Fan] Fan Control (Type: Scaling)	50%, 100%
	1 Byte	O	CR-T-	1.xxx	0/1	[Px][Bx] Room State	0 = Normal; 1 = Make-up room; 2 = Do not disturb
	1 Byte	O	CR-T-	DPT_Value_1_Ucount	0 - 255	[Px][Bx] Enumeration Control	0 ... 255
74, 89, 104, 119, 134, 149, 164, 179, 194, 209, 224, 239, 254, 269, 284, 299, 314, 329, 344, 359, 374, 389, 404, 419, 434, 449, 464, 479, 494, 509, 524, 539, 554, 569, 584, 599, 614, 629, 644, 659, 674, 689, 704, 719, 734, 749, 764, 779, 794, 809, 824, 839, 854, 869, 884, 899	1 Byte	O	CR-T-	DPT_Value_1_Ucount	0 - 255	[Px][Bx] Two Objects - Long Press: (1-Byte)	Send Selected 1-Byte Value on Long Press
75, 90, 105, 120, 135, 150, 165, 180, 195, 210, 225, 240, 255, 270, 285, 300, 315, 330, 345, 360, 375, 390, 405, 420, 435, 450, 465, 480, 495, 510, 525, 540, 555, 570, 585, 600, 615, 630, 645, 660, 675, 690, 705, 720, 735, 750, 765, 780, 795, 810, 825, 840, 855, 870, 885, 900	1 Byte	I/O	CRWTU	DPT_Scaling	0% - 100%	[Px][Bx] Green Channel	0% ... 100%
						[Px][Bx] Blue Channel	0% ... 100%
76, 91, 106, 121, 136, 151, 166, 181, 196, 211, 226, 241, 256, 271, 286, 301, 316, 331, 346, 361, 376, 391, 406, 421, 436, 451, 466, 481, 496, 511, 526, 541, 556, 571, 586,	1 Byte	I/O	CRWTU	DPT_Scaling	0% - 100%	[Px][Bx] White Channel	0% ... 100%

601, 616, 631, 646, 661, 676, 691, 706, 721, 736, 751, 766, 781, 796, 811, 826, 841, 856, 871, 886, 901							
77, 92, 107, 122, 137, 152, 167, 182, 197, 212, 227, 242, 257, 272, 287, 302, 317, 332, 347, 362, 377, 392, 407, 422, 437, 452, 467, 482, 497, 512, 527, 542, 557, 572, 587, 602, 617, 632, 647, 662, 677, 692, 707, 722, 737, 752, 767, 782, 797, 812, 827, 842, 857, 872, 887, 902	2 Bytes	O	CR-T-	DPT_Value_2_Ucount	0 - 65535	[Px][Bx] 2-Byte Unsigned Int Control	0 ... 65535
	2 Bytes	O	CR-T-	DPT_Value_2_Count	-32768 - 32767	[Px][Bx] 2-Byte Signed Int Control	-32768 ... 32767
	2 Bytes	O	CR-T-	9.xxx	-671088.64 - 670433.28	[Px][Bx] 2-Byte Float Control	-671088.64 ... 670433.28
	2 Bytes	O	CR-T-	DPT_Value_Temp	-99° - 199°	[Px][Bx] (Climate) Temperature Setpoint	-99°C ... 199°C
78, 93, 108, 123, 138, 153, 168, 183, 198, 213, 228, 243, 258, 273, 288, 303, 318, 333, 348, 363, 378, 393, 408, 423, 438, 453, 468, 483, 498, 513, 528, 543, 558, 573, 588, 603, 618, 633, 648, 663, 678, 693, 708, 723, 738, 753, 768, 783, 798, 813, 828, 843, 858, 873, 888, 903	2 Bytes	O	CR-T-	DPT_Value_Temp	-99° - 199°	[Px][Setpoint] Temperature Setpoint	-99°C ... 199°C
	1 Bit	I	C-WTU	DPT_Switch	0/1	[Px][Bx] Binary Indicator	1-Bit Indicator
	1 Bit	I	C-WTU	DPT_Heat_Cool	0/1	[Px][Bx] (Climate) Mode Indicator	0 = Cool; 1 = Heat
	1 Bit	I	C-WTU	DPT_Switch	0/1	[Px][Bx] Two Objects - Indicator	1-Bit Indicator
79, 94, 109, 124, 139, 154, 169, 184, 199, 214, 229, 244, 259, 274, 289, 304, 319, 334, 349, 364, 379, 394, 409, 424, 439, 454, 469, 484, 499, 514, 529, 544, 559, 574, 589, 604, 619, 634, 649, 664, 679, 694, 709, 724, 739, 754, 769, 784, 799, 814, 829, 844, 859, 874, 889, 904	1 Bit	I	C-WTU	DPT_Switch	0/1	[Px][Bx] Hold & Release - Indicator	1-Bit Indicator
	1 Byte	I	C-WTU	DPT_Value_1_Ucount	0 - 255	[Px][Bx] Enumerated Indicator	0 ... 255
	1 Byte	I	C-WTU	DPT_Value_1_Ucount	0 - 255	[Px][Bx] 1-Byte Unsigned Int Indicator	0 ... 255
	1 Byte	I	C-WTU	DPT_Value_1_Count	-128 - 127	[Px][Bx] 1-Byte Signed Int Indicator	-128 ... 127
	1 Byte	I	C-WTU	DPT_Scaling	0% - 100%	[Px][Bx] Percentage Indicator	0% ... 100%
	1 Byte	I	C-WTU	DPT_Scaling	0% - 100%	[Px][Bx] Light - Dimming Indicator	0% = Off; 100% = On
	1 Byte	I	C-WTU	DPT_Scaling	0% - 100%	[Px][Bx] Shutter Position	0% = Top; 100% = Bottom
	1 Byte	I	C-WTU	DPT_Scaling	0% - 100%	[Px][Bx] (Climate) Fan Indicator	0% - 100%
	1 Byte	I	C-WTU	DPT_Fan_Stage	0 - 255	[Px][Bx] (Climate) Fan Indicator	Enumerated Value
	1 Byte	I	C-WTU	DPT_Scaling	0% - 100%	[Px][Fan] Fan Indicator	0% ... 100%
1 Byte	I	C-WTU	DPT_HVACContrMode	0=Auto 1=Heat 3=Cool 9=Fan 14=Dry	[Px][Bx] (Climate) Mode Indicator	Auto, Heat, Cool, Fan and Dry	

	1 Byte	I	C - WTU	DPT_HVACMode	1=Comfort 2=Standby 3=Economy 4=Building Protection	[Px][Bx] (Climate) Special Mode Indicator	Auto, Comfort, Standby, Economy and Building Protection
	1 Byte	I	C - WTU	DPT_Value_1_Count	-128 - 127	[Px][Bx] 1-Byte Signed Int Indicator	-128 ... 127
	1 Byte	I	C - WTU	DPT_Value_1_Ucount	0 - 255	[Px][Bx] Enumeration Indicator	0 ... 255
	1 Byte	I	C - WTU	1.xxx	0/1	[Px][Bx] Room State Indicator	0 = Normal; 1 = Make-up room; 2 = Do not disturb
80, 95, 110, 125, 140, 155, 170, 185, 200, 215, 230, 245, 260, 275, 290, 305, 320, 335, 350, 365, 380, 395, 410, 425, 440, 455, 470, 485, 500, 515, 530, 545, 560, 575, 590, 605, 620, 635, 650, 665, 680, 695, 710, 725, 740, 755, 770, 785, 800, 815, 830, 845, 860, 875, 890, 905	2 Bytes	I	C - WTU	DPT_Value_2_Ucount	0 - 65535	[Px][Bx] 2-Byte Unsigned Int Indicator	0 ... 65535
	2 Bytes	I	C - WTU	DPT_Value_2_Count	-32768 - 32767	[Px][Bx] 2-Byte Signed Int Indicator	-32768 ... 32767
	2 Bytes	I	C - WTU	9.xxx	-671088.64 - 670433.28	[Px][Bx] 2-Byte Float Indicator	-671088.64 ... 670433.28
	2 Bytes	I	C - WTU	DPT_Value_Temp	-99° - 199°	[Px][Bx] Temperature Indicator	-99°C ... 199°C
	2 Bytes	I	C - WTU	DPT_Value_2_Count	-32768 - 32767	[Px][Bx] 2-Byte Signed Int Indicator	-32768 ... 32767
	2 Bytes	I	C - WTU	DPT_Value_2_Ucount	0 - 65535	[Px][Bx] 2-Byte Unsigned Int Indicator	0 ... 65535
	2 Bytes	I	C - WTU	DPT_Value_Temp	-99° - 199°	[Px][Bx] (Climate) Temperature Indicator	-99°C ... 199°C
	2 Bytes	I	C - WTU	DPT_Value_Temp	-99° - 199°	[Px][Setpoint] Temperature Indicator	-99°C ... 199°C
81, 96, 111, 126, 141, 156, 171, 186, 201, 216, 231, 246, 261, 276, 291, 306, 321, 336, 351, 366, 381, 396, 411, 426, 441, 456, 471, 486, 501, 516, 531, 546, 561, 576, 591, 606, 621, 636, 651, 666, 681, 696, 711, 726, 741, 756, 771, 786, 801, 816, 831, 846, 861, 876, 891, 906	4 Bytes	I	C - WTU	DPT_Value_4_Count	-2147483648 - 2147483647	[Px][Bx] 4-Byte Signed Int Indicator	-2147483648 ... 2147483647
	4 Bytes	I	C - WTU	14.xxx	-2147483647 - 2147483647	[Px][Bx] 4-Byte Float Indicator	-2147483647 ... 2147483647
82, 97, 112, 127, 142, 157, 172, 187, 202, 217, 232, 247, 262, 277, 292, 307, 322, 337, 352, 367, 382, 397, 412, 427, 442, 457, 472, 487, 502, 517, 532, 547, 562, 577, 592, 607, 622, 637, 652, 667, 682, 697, 712, 727, 742,	14 Bytes	I	C - WTU	DPT_String_UTF-8		[Px][Bx] 14-Byte Text Indicator	Text String
	14 Bytes	I	C - WTU	DPT_String_UTF-8		[Px][Bx] Multimedia Indicator	14-Bytes Text String
	6 Bytes	I/O	CRWTU	DPT_Colour_RGBW	[0 - 1] * 4 - [0 - 255] * 4	[Px][Bx] RGBW Color	Red, Green, Blue and White Components

757, 772, 787, 802, 817, 832, 847, 862, 877, 892, 907							
908	1 Bit	I	C-W--	DPT_Enable	0/1	[General] Proximity Sensor	0 = Disable; 1 = Enable
909	1 Bit	I	C-W--	DPT_Ack	0/1	[General] External Proximity Detection	1 = Detection
910	1 Bit		C--T-	DPT_Ack	0/1	[General] Proximity Detection	Send 1 when Proximity is Detected
911	1 Bit		C--T-	DPT_Boot	0/1	[General] Luminosity (1-Bit)	0 = Over Threshold; 1 = Under Threshold
	1 Bit		C--T-	DPT_Boot	0/1	[General] Luminosity (1-Bit)	0 = Under Threshold; 1 = Over Threshold
912	1 Byte	O	CR---	DPT_Scaling	0% - 100%	[General] Luminosity (Percentage)	0% ... 100%
914	1 Bit	I	C-W--	DPT_DayNight	0/1	[General] Backlight Mode	0 = Night Mode; 1 = Normal Mode
	1 Bit	I	C-W--	DPT_DayNight	0/1	[General] Backlight Mode	0 = Normal Mode; 1 = Night Mode
915	1 Byte	I	C-W--	DPT_Scaling	0% - 100%	[General] Display - Brightness	0% ... 100%
917, 921, 925, 929	2 Bytes	O	CR-T-	DPT_Value_Temp	-273.00° - 670433.28°	[Ix] Current Temperature	Temperature Sensor Value
918, 922, 926, 930	1 Bit	O	CR-T-	DPT_Alarm	0/1	[Ix] Overcooling	0 = No Alarm; 1 = Alarm
919, 923, 927, 931	1 Bit	O	CR-T-	DPT_Alarm	0/1	[Ix] Overheating	0 = No Alarm; 1 = Alarm
920, 924, 928, 932	1 Bit	O	CR-T-	DPT_Alarm	0/1	[Ix] Probe Error	0 = No Alarm; 1 = Alarm
933	2 Bytes	O	CR-T-	DPT_Value_Temp	-273.00° - 670433.28°	[Internal Temp. Probe] Current Temperature	Temperature Sensor Value
934	1 Bit	O	CR-T-	DPT_Alarm	0/1	[Internal Temp. Probe] Overcooling	0 = No Alarm; 1 = Alarm
935	1 Bit	O	CR-T-	DPT_Alarm	0/1	[Internal Temp. Probe] Overheating	0 = No Alarm; 1 = Alarm
936	1 Bit	O	CR-T-	DPT_Boot	0/1	[Internal Temp. Probe] Probe Error	0 = No Alarm; 1 = Alarm
937	2 Bytes	O	CR-T-	DPT_Value_Temp	-273.00° - 670433.28°	[Probe NTC] Current Temperature	Temperature Sensor Value
938	1 Bit	O	CR-T-	DPT_Alarm	0/1	[Probe NTC] Overcooling	0 = No Alarm; 1 = Alarm
939	1 Bit	O	CR-T-	DPT_Alarm	0/1	[Probe NTC] Overheating	0 = No Alarm; 1 = Alarm
940	1 Bit	O	CR-T-	DPT_Boot	0/1	[Probe NTC] Probe Error	0 = No Alarm; 1 = Alarm
941, 947, 953, 959	1 Bit	I	C-W--	DPT_Enable	0/1	[Ix] Input Lock	0 = Unlock; 1 = Lock
942, 948, 954, 960	1 Bit		C--T-	DPT_Switch	0/1	[Ix] [Short Press] 0	Sending of 0
	1 Bit		C--T-	DPT_Switch	0/1	[Ix] [Short Press] 1	Sending of 1
	1 Bit	I	C-WT-	DPT_Switch	0/1	[Ix] [Short Press] 0/1 Switching	Switching 0/1
	1 Bit		C--T-	DPT_UpDown	0/1	[Ix] [Short Press] Move Up Shutter	Sending of 0 (Up)
	1 Bit		C--T-	DPT_UpDown	0/1	[Ix] [Short Press] Move Down Shutter	Sending of 1 (Down)
	1 Bit		C--T-	DPT_UpDown	0/1	[Ix] [Short Press] Move Up/Down Shutter	Switching 0/1 (Up/Down)
	1 Bit		C--T-	DPT_Step	0/1	[Ix] [Short Press] Stop/Step Up Shutter	Sending of 0 (Stop/Step Up)

	1 Bit		C--T-	DPT_Step	0/1	[Ix] [Short Press] Stop/Step Down Shutter	Sending of 1 (Stop/Step Down)
	1 Bit		C--T-	DPT_Step	0/1	[Ix] [Short Press] Stop/Step Shutter (Switched)	Switching of 0/1 (Stop/Step Up/Down)
	4 Bit		C--T-	DPT_Control_Dimming	0x0 (Stop) 0x1 (Dec. by 100%) ... 0x7 (Dec. by 1%) 0x8 (Stop) 0xD (Inc. by 100%) ... 0xF (Inc. by 1%)	[Ix] [Short Press] Brighter	Increase Brightness
	4 Bit		C--T-	DPT_Control_Dimming	0x0 (Stop) 0x1 (Dec. by 100%) ... 0x7 (Dec. by 1%) 0x8 (Stop) 0xD (Inc. by 100%) ... 0xF (Inc. by 1%)	[Ix] [Short Press] Darker	Decrease Brightness
	4 Bit		C--T-	DPT_Control_Dimming	0x0 (Stop) 0x1 (Dec. by 100%) ... 0x7 (Dec. by 1%) 0x8 (Stop) 0xD (Inc. by 100%) ... 0xF (Inc. by 1%)	[Ix] [Short Press] Brighter/Darker	Switch Bright/Dark
	1 Bit		C--T-	DPT_Switch	0/1	[Ix] [Short Press] Light On	Sending of 1 (On)
	1 Bit		C--T-	DPT_Switch	0/1	[Ix] [Short Press] Light Off	Sending of 0 (Off)
	1 Bit	I	C-WT-	DPT_Switch	0/1	[Ix] [Short Press] Light On/Off	Switching 0/1
	1 Byte		C--T-	DPT_SceneControl	0-63; 128-191	[Ix] [Short Press] Run Scene	Sending of 0 - 63
	1 Byte		C--T-	DPT_SceneControl	0-63; 128-191	[Ix] [Short Press] Save Scene	Sending of 128 - 191
	1 Bit	I/O	CRWT-	DPT_Switch	0/1	[Ix] [Switch/Sensor] Edge	Sending of 0 or 1
	1 Byte		C--T-	DPT_Value_1_Ucount	0 - 255	[Ix] [Short Press] Constant Value (Integer)	0 - 255
	1 Byte		C--T-	DPT_Scaling	0% - 100%	[Ix] [Short Press] Constant Value (Percentage)	0% - 100%
	2 Bytes		C--T-	DPT_Value_2_Ucount	0 - 65535	[Ix] [Short Press] Constant Value (Integer)	0 - 65535
	2 Bytes		C--T-	9.xxx	-671088.64 - 670433.28	[Ix] [Short Press] Constant Value (Float)	Float Value
943, 949, 955, 961	1 Byte	I	C-W--	DPT_Scaling	0% - 100%	[Ix] [Short Press] Shutter Status (Input)	0% = Top; 100% = Bottom

	1 Byte	I	C - W - -	DPT_Scaling	0% - 100%	[Ix] [Short Press] Dimming Status (Input)	0% - 100%
944, 950, 956, 962	1 Bit		C - - T -	DPT_Switch	0/1	[Ix] [Long Press] 0	Sending of 0
	1 Bit		C - - T -	DPT_Switch	0/1	[Ix] [Long Press] 1	Sending of 1
	1 Bit	I	C - W T -	DPT_Switch	0/1	[Ix] [Long Press] 0/1 Switching	Switching 0/1
	1 Bit		C - - T -	DPT_UpDown	0/1	[Ix] [Long Press] Move Up Shutter	Sending of 0 (Up)
	1 Bit		C - - T -	DPT_UpDown	0/1	[Ix] [Long Press] Move Down Shutter	Sending of 1 (Down)
	1 Bit		C - - T -	DPT_UpDown	0/1	[Ix] [Long Press] Move Up/Down Shutter	Switching 0/1 (Up/Down)
	1 Bit		C - - T -	DPT_Step	0/1	[Ix] [Long Press] Stop/Step Up Shutter	Sending of 0 (Stop/Step Up)
	1 Bit		C - - T -	DPT_Step	0/1	[Ix] [Long Press] Stop/Step Down Shutter	Sending of 1 (Stop/Step Down)
	1 Bit		C - - T -	DPT_Step	0/1	[Ix] [Long Press] Stop/Step Shutter (Switched)	Switching of 0/1 (Stop/Step Up/Down)
	4 Bit		C - - T -	DPT_Control_Dimming	0x0 (Stop) 0x1 (Dec. by 100%) ... 0x7 (Dec. by 1%) 0x8 (Stop) 0xD (Inc. by 100%) ... 0xF (Inc. by 1%)	[Ix] [Long Press] Brighter	Long Pr. -> Brighter; Release -> Stop
	4 Bit		C - - T -	DPT_Control_Dimming	0x0 (Stop) 0x1 (Dec. by 100%) ... 0x7 (Dec. by 1%) 0x8 (Stop) 0xD (Inc. by 100%) ... 0xF (Inc. by 1%)	[Ix] [Long Press] Darker	Long Pr. -> Darker; Release -> Stop
	4 Bit		C - - T -	DPT_Control_Dimming	0x0 (Stop) 0x1 (Dec. by 100%) ... 0x7 (Dec. by 1%) 0x8 (Stop) 0xD (Inc. by 100%) ... 0xF (Inc. by 1%)	[Ix] [Long Press] Brighter/Darker	Long Pr. -> Brighter/Darker; Release -> Stop
	1 Bit		C - - T -	DPT_Switch	0/1	[Ix] [Long Press] Light On	Sending of 1 (On)
	1 Bit		C - - T -	DPT_Switch	0/1	[Ix] [Long Press] Light Off	Sending of 0 (Off)
1 Bit	I	C - W T -	DPT_Switch	0/1	[Ix] [Long Press] Light On/Off	Switching 0/1	
1 Byte		C - - T -	DPT_SceneControl	0-63; 128-191	[Ix] [Long Press] Run Scene	Sending of 0 - 63	

	1 Byte		C--T-	DPT_SceneControl	0-63; 128-191	[Ix] [Long Press] Save Scene	Sending of 128 - 191
	1 Bit	O	CR-T-	DPT_Alarm	0/1	[Ix] [Switch/Sensor] Alarm: Breakdown or Sabotage	1 = Alarm; 0 = No Alarm
	2 Bytes		C--T-	9.xxx	-671088.64 - 670433.28	[Ix] [Long Press] Constant Value (Float)	Float Value
	2 Bytes		C--T-	DPT_Value_2_Ucount	0 - 65535	[Ix] [Long Press] Constant Value (Integer)	0 - 65535
	1 Byte		C--T-	DPT_Scaling	0% - 100%	[Ix] [Long Press] Constant Value (Percentage)	0% - 100%
	1 Byte		C--T-	DPT_Value_1_Ucount	0 - 255	[Ix] [Long Press] Constant Value (Integer)	0 - 255
945, 951, 957, 963	1 Bit		C--T-	DPT_Trigger	0/1	[Ix] [Long Press/Release] Stop Shutter	Release -> Stop Shutter
946, 952, 958, 964	1 Byte	I	C-W--	DPT_Scaling	0% - 100%	[Ix] [Long Press] Dimming Status (Input)	0% - 100%
	1 Byte	I	C-W--	DPT_Scaling	0% - 100%	[Ix] [Long Press] Shutter Status (Input)	0% = Top; 100% = Bottom
965	1 Byte	I	C-W--	DPT_SceneNumber	0 - 63	[Motion Detector] Scene Input	Scene Value
966	1 Byte		C--T-	DPT_SceneControl	0-63; 128-191	[Motion Detector] Scene Output	Scene Value
967, 996, 1025, 1054	1 Byte	O	CR-T-	DPT_Scaling	0% - 100%	[Ix] Luminosity	0-100%
968, 997, 1026, 1055	1 Bit	O	CR-T-	DPT_Alarm	0/1	[Ix] Open Circuit Error	0 = No Error; 1 = Open Circuit Error
969, 998, 1027, 1056	1 Bit	O	CR-T-	DPT_Alarm	0/1	[Ix] Short Circuit Error	0 = No Error; 1 = Short Circuit Error
970, 999, 1028, 1057	1 Byte	O	CR-T-	DPT_Scaling	0% - 100%	[Ix] Presence State (Scaling)	0-100%
971, 1000, 1029, 1058	1 Byte	O	CR-T-	DPT_HVACMode	1=Comfort 2=Standby 3=Economy 4=Building Protection	[Ix] Presence State (HVAC)	Auto, Comfort, Standby, Economy, Building Protection
972, 1001, 1030, 1059	1 Bit	O	CR-T-	DPT_Switch	0/1	[Ix] Presence State (Binary)	Binary Value
	1 Bit	O	CR-T-	DPT_Ack	0/1	[Ix] Presence: Slave Output	1 = Motion Detected
973, 1002, 1031, 1060	1 Bit	I	C-W--	DPT_Window_Door	0/1	[Ix] Presence Trigger	Binary Value to Trigger the Presence Detection
974, 1003, 1032, 1061	1 Bit	I	C-W--	DPT_Ack	0/1	[Ix] Presence: Slave Input	0 = Nothing; 1 = Detection from slave device
975, 1004, 1033, 1062	2 Bytes	I	C-W--	DPT_TimePeriodSec	0 - 65535	[Ix] Presence: Waiting Time	0-65535 s.
976, 1005, 1034, 1063	2 Bytes	I	C-W--	DPT_TimePeriodSec	0 - 65535	[Ix] Presence: Listening Time	1-65535 s.
977, 1006, 1035, 1064	1 Bit	I	C-W--	DPT_Enable	0/1	[Ix] Presence: Enable	According to parameters
978, 1007, 1036, 1065	1 Bit	I	C-W--	DPT_DayNight	0/1	[Ix] Presence: Day/Night	According to parameters
979, 1008, 1037, 1066	1 Bit	O	CR-T-	DPT_Occupancy	0/1	[Ix] Presence: Occupancy State	0 = Not Occupied; 1 = Occupied

980, 1009, 1038, 1067	1 Bit	I	C - W - -	DPT_Ack	0/1	[Ix] External Motion Detection	0 = Nothing; 1 = Motion detected by an external sensor
981, 986, 991, 1010, 1015, 1020, 1039, 1044, 1049, 1068, 1073, 1078	1 Byte	O	C R - T -	DPT_Scaling	0% - 100%	[Ix] [Cx] Detection State (Scaling)	0-100%
982, 987, 992, 1011, 1016, 1021, 1040, 1045, 1050, 1069, 1074, 1079	1 Byte	O	C R - T -	DPT_HVACMode	1=Comfort 2=Standby 3=Economy 4=Building Protection	[Ix] [Cx] Detection State (HVAC)	Auto, Comfort, Standby, Economy, Building Protection
983, 988, 993, 1012, 1017, 1022, 1041, 1046, 1051, 1070, 1075, 1080	1 Bit	O	C R - T -	DPT_Switch	0/1	[Ix] [Cx] Detection State (Binary)	Binary Value
984, 989, 994, 1013, 1018, 1023, 1042, 1047, 1052, 1071, 1076, 1081	1 Bit	I	C - W - -	DPT_Enable	0/1	[Ix] [Cx] Enable Channel	According to parameters
985, 990, 995, 1014, 1019, 1024, 1043, 1048, 1053, 1072, 1077, 1082	1 Bit	I	C - W - -	DPT_Switch	0/1	[Ix] [Cx] Force State	0 = No Detection; 1 = Detection
1083	1 Byte	I	C - W - -	DPT_SceneControl	0-63; 128-191	[Thermostat] Scene Input	Scene Value
1084, 1122	2 Bytes	I	C - W - -	DPT_Value_Temp	-273.00° - 670433.28°	[Tx] Temperature Source 1	External Sensor Temperature
1085, 1123	2 Bytes	I	C - W - -	DPT_Value_Temp	-273.00° - 670433.28°	[Tx] Temperature Source 2	External Sensor Temperature
1086, 1124	2 Bytes	O	C R - T -	DPT_Value_Temp	-273.00° - 670433.28°	[Tx] Effective Temperature	Effective Control Temperature
1087, 1125	1 Byte	I	C - W - -	DPT_HVACMode	1=Comfort 2=Standby 3=Economy 4=Building Protection	[Tx] Special Mode	1-Byte HVAC Mode
1088, 1126	1 Bit	I	C - W - -	DPT_Ack	0/1	[Tx] Special Mode: Comfort	0 = Nothing; 1 = Trigger
	1 Bit	I	C - W - -	DPT_Switch	0/1	[Tx] Special Mode: Comfort	0 = Off; 1 = On
1089, 1127	1 Bit	I	C - W - -	DPT_Ack	0/1	[Tx] Special Mode: Standby	0 = Nothing; 1 = Trigger
	1 Bit	I	C - W - -	DPT_Switch	0/1	[Tx] Special Mode: Standby	0 = Off; 1 = On
1090, 1128	1 Bit	I	C - W - -	DPT_Ack	0/1	[Tx] Special Mode: Economy	0 = Nothing; 1 = Trigger
	1 Bit	I	C - W - -	DPT_Switch	0/1	[Tx] Special Mode: Economy	0 = Off; 1 = On
1091, 1129	1 Bit	I	C - W - -	DPT_Ack	0/1	[Tx] Special Mode: Protection	0 = Nothing; 1 = Trigger
	1 Bit	I	C - W - -	DPT_Switch	0/1	[Tx] Special Mode: Protection	0 = Off; 1 = On
1092, 1130	1 Bit	I	C - W - -	DPT_Window_Door	0/1	[Tx] Window Status (Input)	0 = Closed; 1 = Open
1093, 1131	1 Bit	I	C - W - -	DPT_Ack	0/1	[Tx] Comfort Prolongation	0 = Nothing; 1 = Timed Comfort
1094, 1132	1 Byte	O	C R - T -	DPT_HVACMode	1=Comfort 2=Standby 3=Economy 4=Building Protection	[Tx] Special Mode Status	1-Byte HVAC Mode

1095, 1133	2 Bytes	I	C - W - -	DPT_Value_Temp	-273.00° - 670433.28°	[Tx] Setpoint	Thermostat Setpoint Input
	2 Bytes	I	C - W - -	DPT_Value_Temp	-273.00° - 670433.28°	[Tx] Basic Setpoint	Reference Setpoint
1096, 1134	1 Bit	I	C - W - -	DPT_Step	0/1	[Tx] Setpoint Step	0 = Decrease Setpoint; 1 = Increase Setpoint
1097, 1135	2 Bytes	I	C - W - -	DPT_Value_Tempd	-670760.00° - 670433.28°	[Tx] Setpoint Offset	Float Offset Value
1098, 1136	2 Bytes	O	CR - T -	DPT_Value_Temp	-273.00° - 670433.28°	[Tx] Setpoint Status	Current Setpoint
1099, 1137	2 Bytes	O	CR - T -	DPT_Value_Temp	-273.00° - 670433.28°	[Tx] Basic Setpoint Status	Current Basic Setpoint
1100, 1138	2 Bytes	O	CR - T -	DPT_Value_Tempd	-670760.00° - 670433.28°	[Tx] Setpoint Offset Status	Current Setpoint Offset
1101, 1139	1 Bit	I	C - W - -	DPT_Reset	0/1	[Tx] Setpoint Reset	Reset Setpoint to Default
	1 Bit	I	C - W - -	DPT_Reset	0/1	[Tx] Offset Reset	Reset Offset
1102, 1140	1 Bit	I	C - W - -	DPT_Heat_Cool	0/1	[Tx] Mode	0 = Cool; 1 = Heat
1103, 1141	1 Bit	O	CR - T -	DPT_Heat_Cool	0/1	[Tx] Mode Status	0 = Cool; 1 = Heat
1104, 1142	1 Bit	I	C - W - -	DPT_Switch	0/1	[Tx] On/Off	0 = Off; 1 = On
1105, 1143	1 Bit	O	CR - T -	DPT_Switch	0/1	[Tx] On/Off Status	0 = Off; 1 = On
1106, 1144	1 Bit	I/O	CRW - -	DPT_Switch	0/1	[Tx] Main System (Cool)	0 = System 1; 1 = System 2
1107, 1145	1 Bit	I/O	CRW - -	DPT_Switch	0/1	[Tx] Main System (Heat)	0 = System 1; 1 = System 2
1108, 1146	1 Bit	I	C - W - -	DPT_Enable	0/1	[Tx] Enable/Disable Secondary System (Cool)	0 = Disable; 1 = Enable
1109, 1147	1 Bit	I	C - W - -	DPT_Enable	0/1	[Tx] Enable/Disable Secondary System (Heat)	0 = Disable; 1 = Enable
1110, 1116, 1148, 1154	1 Byte	O	CR - T -	DPT_Scaling	0% - 100%	[Tx] [Sx] Control Variable (Cool)	PI Control (Continuous)
1111, 1117, 1149, 1155	1 Byte	O	CR - T -	DPT_Scaling	0% - 100%	[Tx] [Sx] Control Variable (Heat)	PI Control (Continuous)
	1 Byte	O	CR - T -	DPT_Scaling	0% - 100%	[Tx] [Sx] Control Variable	PI Control (Continuous)
1112, 1118, 1150, 1156	1 Bit	O	CR - T -	DPT_Switch	0/1	[Tx] [Sx] Control Variable (Cool)	2-Point Control
	1 Bit	O	CR - T -	DPT_Switch	0/1	[Tx] [Sx] Control Variable (Cool)	PI Control (PWM)
1113, 1119, 1151, 1157	1 Bit	O	CR - T -	DPT_Switch	0/1	[Tx] [Sx] Control Variable (Heat)	2-Point Control
	1 Bit	O	CR - T -	DPT_Switch	0/1	[Tx] [Sx] Control Variable (Heat)	PI Control (PWM)
	1 Bit	O	CR - T -	DPT_Switch	0/1	[Tx] [Sx] Control Variable	2-Point Control
	1 Bit	O	CR - T -	DPT_Switch	0/1	[Tx] [Sx] Control Variable	PI Control (PWM)
1114, 1120, 1152, 1158	1 Bit	O	CR - T -	DPT_Switch	0/1	[Tx] [Sx] PI State (Cool)	0 = PI Signal 0%; 1 = PI Signal Greater than 0%
1115, 1121, 1153, 1159	1 Bit	O	CR - T -	DPT_Switch	0/1	[Tx] [Sx] PI State (Heat)	0 = PI Signal 0%; 1 = PI Signal Greater than 0%
	1 Bit	O	CR - T -	DPT_Switch	0/1	[Tx] [Sx] PI State	0 = PI Signal 0%; 1 = PI Signal Greater than 0%

Join and send us your inquiries
about Zennio devices:

<http://support.zennio.com>

Zennio Avance y Tecnología S.L.
C/ Río Jarama, 132. Nave P-8.11
45007 Toledo (Spain).

Tel. +34 925 232 002.

www.zennio.com
info@zennio.com

