

Technical Manual



MDT Heating Actuator

AKH-0400.03

AKH-0600.03

AKH-0800.03

Further Documents:

Datasheet:

https://www.mdt.de/EN_Downloads_Datasheets.html

Assembly and Operation Instructions:

https://www.mdt.de/EN_Downloads_Instructions.html

Solution Proposals for MDT products:

https://www.mdt.de/EN_Downloads_Solutions.html

1 Content

1 Content	2
2 Overview	5
2.1 Overview Devices	5
2.2 Special features.....	6
2.3 Connection diagrams.....	8
2.4 Structure & Handling	9
2.5 Test mode	9
2.6 Error messages – Channel LEDs.....	10
2.7 Commissioning.....	10
3 Communication objects	11
3.1 Standard settings of the communication objects	11
4 Reference ETS-Parameter	14
4.1 General settings	14
4.1.1 Device configuration	15
4.1.2 Operating mode – Heating system – Heating/Cooling switchover	17
4.1.3 Summer/Winter mode	19
4.1.4 Setpoint Frost/Heat protection.....	21
4.1.5 Object max. control value.....	22
4.1.6 Requirement for Heating/Cooling	23
4.1.7 Behaviour after bus power return	25
4.1.8 Language for diagnosis text.....	26
4.1.8.1 Diagnosis texts as plain text	27
4.2 Channel selection	28
4.3 Channel – Basic setting	29
4.3.1 Identical settings: Description of channel/objects & Additional text.....	29
4.3.1 Channel basic setting – Control mode.....	30
4.4 Channel Configuration – Switching (1 Bit).....	31
4.4.1 Basic setting	31
4.4.2 Output.....	32
4.4.2.1 General settings	32
4.4.2.2 Forced position/Dew point alarm	33
4.4.2.3 Emergency mode	34
4.4.2.4 Lock objects	34
4.4.2.5 Send diagnosis text.....	35

4.5 Channel Configuration – Continuous (1 Byte).....	36
4.5.1 Basic setting	36
4.5.2 Output.....	37
4.5.2.1 General settings	38
4.5.2.2 PWM cycle time.....	39
4.5.2.3 Limitation of control value.....	42
4.5.2.4 Control value when falling below the minimum limitation.....	43
4.5.2.5 Object valve status.....	44
4.5.2.6 Forced position/Dew point alarm	45
4.5.2.7 Additional sensor for flow temperature.....	46
4.5.2.8 Additional sensor for cooling medium	47
4.5.2.9 Emergency mode.....	48
4.5.2.10 Lock objects	48
4.5.2.11 Send diagnosis text.....	49
4.6 Channel Configuration – Integrated Controller.....	50
4.6.1 Basic setting	50
4.6.1.1 Additional stage.....	53
4.6.2 Controller.....	54
4.6.2.1 Setpoints, dead zone, operating modes & priorities	55
4.6.2.1.1 Setpoints: Dependent on “(Basic) Comfort setpoint”.....	55
4.6.2.1.2 Dead zone	57
4.6.2.1.3 Independent setpoints	58
4.6.2.1.4 Priority of the operating modes	59
4.6.2.2 Operating mode switchover (Mode selection).....	59
4.6.2.3 Setpoint shift.....	61
4.6.2.4 Comfort extension with time	64
4.6.2.5 Operating mode after reset	65
4.6.2.6 HVAC Status objects.....	66
4.6.2.7 Reference control via outside temperature	68
4.6.2.8 Alarms	71
4.6.2.9 Window contact.....	72
4.6.3 Output.....	74
4.6.3.1 General settings	75
4.6.3.2 PWM cycle time.....	76
4.6.3.3 Limitation of control value.....	79
4.6.3.4 Control value when falling below the minimum limitation.....	80
4.6.3.5 Object valve status.....	81
4.6.3.6 Forced position/Dew point alarm	82

4.6.3.7 Additional sensor for flow temperature.....	83
4.6.3.8 Additional sensor for cooling medium	84
4.6.3.9 Emergency mode	85
4.6.3.10 Lock objects	85
4.6.3.11 Send diagnosis text.....	86
4.7 Scenes.....	87
4.7.1 Activate scenes	87
4.7.2 Submenu – Scene	88
5 Index	89
5.1 Register of illustrations	89
5.2 List of tables	90
6 Appendix.....	92
6.1 Statutory requirements	92
6.2 Disposal	92
6.3 Assembly	92
6.4 Revision history.....	93

2 Overview

2.1 Overview Devices

The description refers to the following units (order number printed in bold):

- **AKH-0400.03** Heating Actuator 4-fold, 2SU MDRC, 24-230VAC
 - 4 channels, to control electrothermic valve drives, with LED indication per channel
- **AKH-0600.03** Heating Actuator 6-fold, 3SU MDRC, 24-230VAC
 - 6 channels, to control electrothermic valve drives, with LED indication per channel
- **AKH-0800.03** Heating Actuator 8-fold, 4SU MDRC, 24-230VAC
 - 8 channels, to control electrothermic valve drives, with LED indication per channel



**Attention: Each actuator can be supplied with either 230VAC or 24VAC.
A mixture of both voltages on one actuator is not permitted!**

2.2 Special features

The Heating Actuators have a very extensive application with special functions:

Integrated PI temperature controller (heating and cooling)

A comprehensive PI temperature controller is integrated in the MDT Heating Actuator. To control the room temperature, only the setpoint and current temperature of the room are required. These are provided, for example, by the MDT Glass Push Buttons with temperature sensor. The combination of MDT Heating actuator and MDT Glass Push Button with temperature sensor enables an inexpensive individual room control without an additional room temperature controller. In addition to continuous control, 2-point control is also possible for the output.

Setpoint setting via absolute values

With the integrated controller in the new heating actuator, it is possible to configure the setpoints completely individually, independently of the basic comfort setpoint. This ensures compatibility with other visualisations.

Minimum flow temperature

It is possible to set a minimum comfort temperature for the floor heating, e.g., for the bathroom. To do this, the floor temperature is measured with an additional floor sensor and kept at 18°C, for example. This avoids a "cold" floor in transitional periods.

Extended setpoint shift

In addition to plus/minus (1 bit) and a 2-byte temperature, the setpoint shift can also be carried out with a 1-byte shift. Setpoints are saved and retained in the event of bus voltage failure.

Automatic heating/cooling switchover

The actuator can automatically switch the operating mode Heating/Cooling. A room is used as a reference for this.

Comfort extension

The actuator can be switched back to comfort mode by object for a configurable time if it was already in night mode.

Plain text diagnosis

The heating actuator has a plain text diagnosis and outputs the current status/error status via a 14-byte object per channel. This allows errors to be localised in a short time. This makes commissioning much easier for the system integrator.

Lock heating operation when windows are open

If the window of a room is opened, the heating actuator blocks the heating operation and goes into frost protection mode. As soon as the window is closed, the heating mode is activated again.

Additional stage heating

In the integrated controller, an additional stage can be activated for heating operation. This can be used with sluggish systems to shorten the heating phase. For example, in the case of underfloor heating (as the basic stage), a radiator or an electric heater (as the additional stage) could be used to shorten the longer heating phase of the sluggish underfloor heating.

Automatic calculation to determine summer/winter

In addition to switching by object, the new heating actuator has the option of automatic calculation to determine summer and winter operation via time/date and outdoor temperature.

Energy optimisation through pump shutdown

The MDT heating actuator has the heating/cooling request object. If there is a heat demand in the rooms (here in the example of heating mode) and the heating circuit valves are open (control values greater than zero), the heating requirement object remains at 1 and the circulation pump is switched on. If the heat demand is covered and all heating circuit valves are closed (control values zero), the heating demand object is set to 0 and the circulation pump is switched off. A follow-up time of up to 30 minutes can be defined for the pump. As soon as a heating circuit requests heat again, the pump is switched on. Especially in transition phases and in summer, energy can be saved by switching off the pump.

Uniform pump load

The outputs can be controlled with a time delay in order to load the circulation pump evenly.

Emergency mode

Emergency operation can be activated for each channel. This monitors whether an input signal is received within a set time. If the actuator does not receive a telegram, the respective channel of the heating actuator goes into emergency mode.

Sticking protection for valves

If heating valves are not used for a longer period, there is a danger that they will become stuck. To avoid this, a protective function is integrated in the heating actuator. When activated, the heating valve is opened and closed for 5 minutes every 6 days.

Internal connection of outputs

When more than one valve output is required for a control channel, it is possible to control one or more additional outputs quickly and clearly.

Extended scene function

In addition to the setpoint temperature, the extended scene function can also switch the Comfort, Night, Standby and Frost/Heat protection operating modes.

Long Frame Support

Device supports the sending of longer telegrams and thus the storage of more user data per telegram. This significantly shortens the programming time (from ETS5).

Requirements: Use of a programming interface which supports the transmission of long frames, e.g., MDT SCN-USBR.02 or SCN-IP000.03 / SCN-IP100.03.

Updateable via DCA

If necessary, the actuators can be updated with the help of the MDT Update Tool.

2.3 Connection diagrams

With the AKH-0400.03, one phase is to be connected for all 4 channels (A-D), with the AKH-0800.03, one phase each for channels A-D and E-H. With the AKH-0600.03, one phase is to be connected for all 6 channels (A-F).

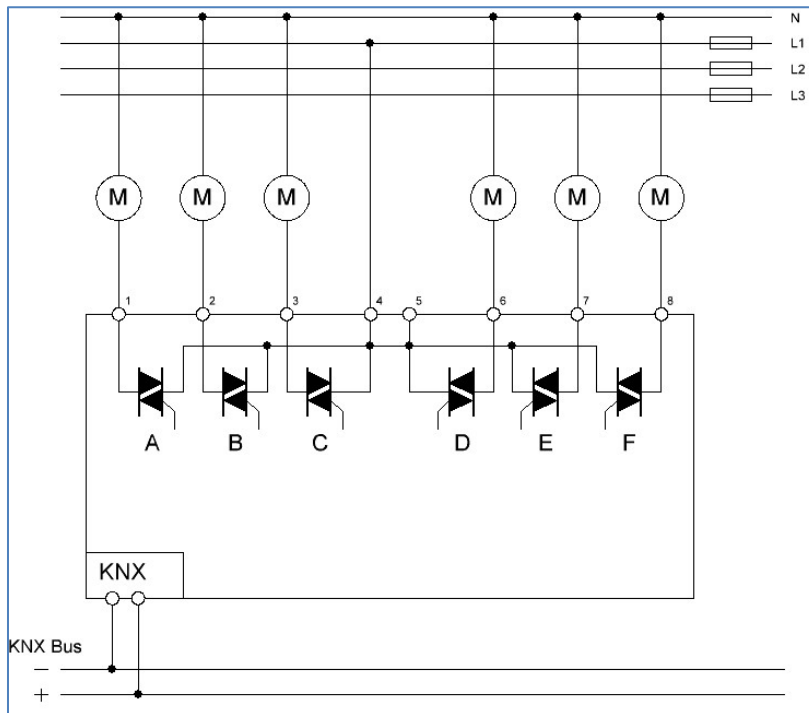

Figure 1: Connection diagram – AKH-0600.03

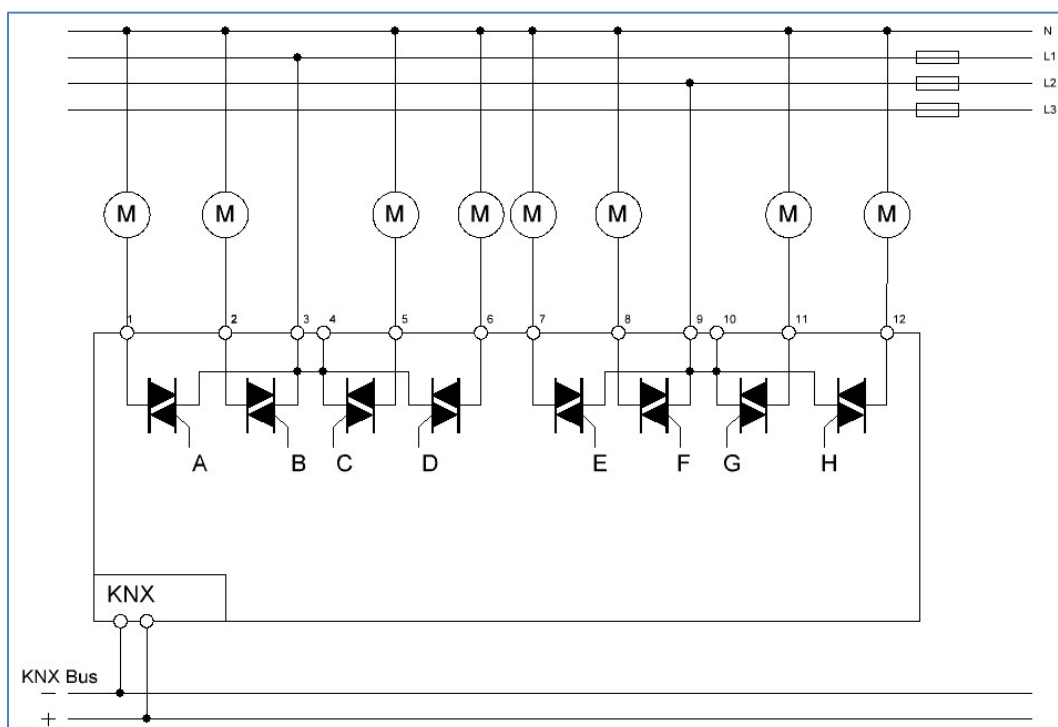

Figure 2: Connection diagram – AKH-0800.03

2.4 Structure & Handling

The following picture shows the structure of the MDT Heating Actuator:

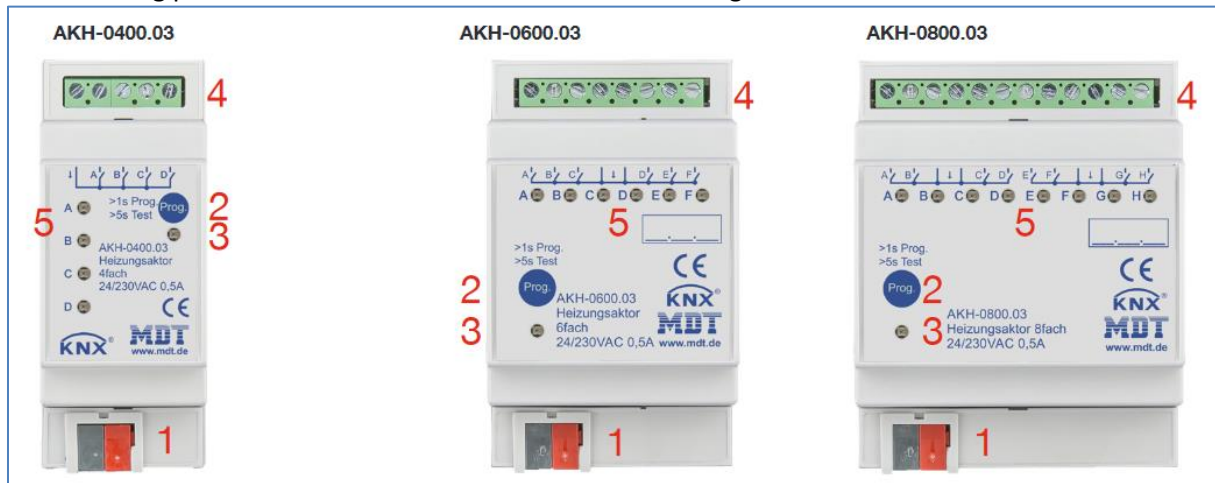

Figure 3: Overview – Hardware modules

- | | |
|---------------------------------|---------------------------|
| 1 = KNX bus connection terminal | 2 = Programming button |
| 3 = Red programming LED | 4 = Output power terminal |
| 5 = Green Status LED | |

2.5 Test mode

Test mode is activated when the "Prog." key is pressed for more than 5 seconds.

After activation, all active channels are energised one after the other for 3 minutes. This is indicated by the corresponding channel LED lighting up continuously. By briefly pressing the "Prog." key, you can switch directly to the next channel. The test mode is ended either automatically after the time of the last active channel has elapsed or by briefly pressing the "Prog." key again when the last channel is selected.

2.6 Error messages – Channel LEDs

Each channel has an LED that indicates the switching status of the respective channel. In addition to the status, these channel LEDs also indicate failures.

The errors are displayed as follows:

- **2x flashing, long break, 2x flashing...**
The channel is in emergency mode due to missing control value.
- **3x flashing, long break, 3x flashing ...**
In 230V operation, a mains failure is detected and signalled by flashing.
Since 4 channels are always supplied together in the 4-fold/8-fold actuator, 4 channels also flash simultaneously in the same rhythm. With the 6-fold actuator, all 6 channels are supplied together, but 3 channels (A/B/C and D/E/F) are separated internally. This means that 3 channels would flash at the same time.
With the 4-fold actuator, channel A must always be connected, with the 8-fold actuator, channel E must also be connected when using channels E-H. With the 6-fold actuator, channel A and channel D must be connected accordingly.
If this is not the case, the actuator goes into error mode and signals this via the simultaneous flashing of all channel LEDs.
- **4x flashing, long break, 4x flashing ...**
The belonging channel is at the overload mode or has a short circuit at the output.

The normal behaviour of the actuator is also shown via these LEDs as described below:

- **switching mode (1 Bit)**
The LED shows the switching behaviour of the output. If the 2-step controller sends a 1-signal, the LED is switched on.
- **continuous mode (1 Byte)/ integrated controller**
The LED operates at the PWM mode with the fixed period of 4s and flashes with the cadence of the control value. At a control value of 50%, the LED will shine for 2s and will be off for 2s.

2.7 Commissioning

After wiring, the allocation of the physical address and the parameterization of every channel follow:

- (1) Connect the interface with the bus, e.g., MDT USB interface.
- (2) Switch on the bus voltage.
- (3) Press the programming button at the device >1s (red programming LED lights).
- (4) Loading of the physical address out of the ETS-Software by using the interface (red LED goes out, as well this process was completed successful).
- (5) Loading of the application, with requested configuration.
- (6) If the device is enabled, you can test the requested functions (also possible by using the ETS-Software).

3 Communication objects

3.1 Standard settings of the communication objects

The following tables show the default settings of the communication objects:

Standard settings – Per channel								
No.	Name	Function	Length	C	R	W	T	U
1	Channel A	Input control value	1 Bit	X		X	X	X
1	Channel A	Input control value	1 Byte	X		X	X	X
1	Channel A	Receive temperature value	2 Byte	X		X	X	X
2	Channel A	Preset setpoint	2 Byte	X		X		
3	Channel A	Preset Comfort setpoint	2 Byte	X		X		
3	Channel A	Preset (Basic) Comfort setpoint	2 Byte	X		X		
3	Channel A	Combi object: Preset setpoint	8 Byte	X		X		
3	Channel A	Combi object (Heating): Preset setpoint	8 Byte	X		X		
4	Channel A	Preset Standby setpoint	2 Byte	X		X		
5	Channel A	Preset Night setpoint	2 Byte	X		X		
6	Channel A	Preset Heat protection setpoint	2 Byte	X		X		
6	Channel A	Preset Frost protection setpoint	2 Byte	X		X		
7	Channel A	Combi object (Cooling): Preset setpoint	8 Byte	X		X		
8	Channel A	Send current setpoint	2 Byte	X	X		X	
9	Channel A	Manual setpoint shift (2 byte)	2 Byte	X		X		
10	Channel A	Manual setpoint shift (1=+ / 0=-)	1 Bit	X		X		
10	Channel A	Manual setpoint shift (1 byte)	1 Byte	X		X		
11	Channel A	Send status of setpoint shift	2 Byte	X	X		X	
12	Channel A	Control value: Send status	1 Byte	X	X		X	
12	Channel A	Control value Heating: Send status	1 Byte	X	X		X	
13	Channel A	Control value Cooling: Send status	1 Byte	X	X		X	
14	Channel A	Control value > 0%: send status	1 Bit	X	X		X	
15	Channel A	Send valve status: open=1, closed=0	1 Bit	X	X		X	
15	Channel A	Send valve status Heating: open=1, closed=0	1 Bit	X	X		X	
16	Channel A	Additional stage: Send control value Heating	1 Bit	X	X		X	
17	Channel A	Mode selection	1 Byte	X		X		
18	Channel A	Comfort operating mode: Comfort extension	1 Bit	X		X		
19	Channel A	Switch Comfort operating mode	1 Bit	X		X		
20	Channel A	Switch Night operating mode	1 Bit	X		X		
21	Channel A	Switch Frost protection operating mode	1 Bit	X		X		
21	Channel A	Switch Heat protection operating mode	1 Bit	X		X		
21	Channel A	Switch Frost/Heat protection operating mode	1 Bit	X		X		

22	Channel A	DPT_HVAC Status: Send controller status	1 Byte	X	X		X	
22	Channel A	DPT_HVAC Mode: Send controller status	1 Byte	X	X		X	
23	Channel A	DPT_RTSM combined status: Send controller status	1 Byte	X	X		X	
23	Channel A	DPT_RTC combined status: Send controller status	2 Byte	X	X		X	
23	Channel A	DPT_HVAC Status: Send controller status	1 Byte	X	X		X	
23	Channel A	DPT_HVAC Mode: Send controller status	1 Byte	X	X		X	
23	Channel A	DPT_RHCC Status: Send controller status	2 Byte	X	X		X	
24	Channel A	Send frost alarm	1 Bit	X	X		X	
25	Channel A	Send Heat alarm	1 Bit	X	X		X	
26	Channel A	Receive flow temperature Heating	2 Byte	X		X	X	
27	Channel A	Receive surface temperature Cooling	2 Byte	X		X	X	
28	Channel A	Diagnosis status	14 Byte	X	X		X	
29	Channel A	Window contact: 1=closed / 0=opened	1 Bit	X		X	X	X
29	Channel A	Window contact: 0=closed / 1=opened	1 Bit	X		X	X	X
30	Channel A	Lock object Heating: Lock control value	1 Bit	X	X	X	X	X
30	Channel A	Enable object Heating: Enable control value	1 Bit	X	X	X	X	X
31	Channel A	Lock object Cooling: Lock control value	1 Bit	X	X	X	X	X
31	Channel A	Enable object Cooling: Enable control value	1 Bit	X	X	X	X	X
32	Channel A	Forced position	1 Bit	X		X		
32	Channel A	Dew point alarm	1 Bit	X		X		
33	Channel A	Override: Minimum control value	1 Byte	X		X		
34	Channel A	Override: Maximum control value	1 Byte	X		X		
35	Channel A	Fault in case of mains failure / short circuit / control value error	1 Bit	X	X		X	
+40	next channel							

Table 1: Communication objects – Standard settings per channel

The following table shows the default settings for the generally valid objects (central objects), here using the **AKH-0400.03** as an example: *

Standard settings – Central objects								
No.	Name	Object Function	Length	C	R	W	T	U
161	Summer = 1/ Winter = 0	Switchover	1 Bit	X		X	X	X
161	Summer = 1/ Winter = 0	Summer/Winter override for 7 days	1 Bit	X		X	X	X
161	Summer = 0/ Winter = 1	Switchover	1 Bit	X		X	X	X
161	Summer = 0/ Winter = 1	Summer/Winter override for 7 days	1 Bit	X		X	X	X
162	Sommer = 1/ Winter = 0	Status	1 Bit	X	X		X	
162	Sommer = 0/ Winter = 1	Status	1 Bit	X	X		X	
163	Heating / Cooling	Switchover	1 Bit	X		X	X	X
164	Heating / Cooling	Status	1 Bit	X	X		X	
165	Heating requirement	0 if control value = 0%, else 1	1 Bit	X	X		X	
165	Heating/Cooling requirement	0 if control value = 0%, else 1	1 Bit	X	X		X	
165	Heating requirement	0 if all valves closed, else 1	1 Bit	X	X		X	
165	Heating/Cooling requirement	0 if all valves closed, else 1	1 Bit	X	X		X	
166	Cooling requirement	0 if control value = 0%, else 1	1 Bit	X	X		X	
166	Cooling requirement	0 if all valves closed, else 1	1 Bit	X	X		X	
167	Fault	At power failure / short circuit	1 Bit	X	X		X	
168	Max. control value (Heating)	Output	1 Byte	X	X		X	
168	Max. control value	Output	1 Byte	X	X		X	
169	Max. control value (Heating)	Input	1 Byte	X		X		
169	Max. control value	Input	1 Byte	X		X		
170	Max. control value (Cooling)	Output	1 Byte	X	X		X	
171	Max. control value (Cooling)	Input	1 Byte	X		X		
172	Scene	Activate	1 Byte	X		X		
173	Central function	Operating	1 Bit	X	X		X	
174	Lead value (Outside temperature)	Receive measured value	2 Byte	X		X		
175	Time	Receive current value	3 Byte	X		X	X	X
176	Date	Receive current value	3 Byte	X		X	X	X
177	Time / Date	Receive current value	8 Byte	X		X	X	X

Table 2: Communication objects – Central objects

* Objects for central functions are always at the end of the object list. Object numbers are therefore dependent on the number of channels of each unit. For example, the central function "Switchover Heating/Cooling" is object no. 163 for an AKH-0400.03, no. 243 for an AKH-0600.03 and no. 323 for an AKH-0800.03. Difference of object numbers of 4-fold → 6-fold → 8-fold is **+80** each.

The tables above show the default settings. The priority of the individual communication objects and the flags can be adjusted by the user as required. The flags assign the communication objects their respective tasks in the programming. "C" stands for communication, "R" for reading, "W" for writing, "T" for transmitting and "U" for updating.

4 Reference ETS-Parameter

4.1 General settings

The following picture shows the general settings. These affect all channels:

Startup time	<input type="text" value="2"/> s
Send "Operation" cyclically	<input type="text" value="not active"/>
Thermal drive	<input type="radio"/> 24VAC <input checked="" type="radio"/> 230VAC
Sticking protection (valve open/closed for 5 minutes every 6 days)	<input type="radio"/> not active <input checked="" type="radio"/> active
<hr/>	
Selection: Operating mode	<input type="text" value="Heating and Cooling"/>
Selection: Heating system	<input checked="" type="radio"/> 2-pipe / 1 circuit (Heating or Cooling) <input type="radio"/> 4-pipe / 2 circuit (Heating and Cooling separat...)
Switchover for Heating/Cooling	<input type="text" value="via object Summer / Winter"/>
Send status object Heating/Cooling cyclically	<input type="text" value="not active"/>
Determination of Summer/Winter	<input checked="" type="radio"/> via object <input type="radio"/> automatic calculation
Polarity for object "Summer/Winter"	<input checked="" type="radio"/> Summer = 1 / Winter = 0 <input type="radio"/> Summer = 0 / Winter = 1
Setpoint Frost protection for all channels	<input type="text" value="7"/> °C
Setpoint Heat protection for all channels	<input type="text" value="35"/> °C
Object maximum control value	<input type="text" value="not active"/>
Object for requirement Heating/Cooling	<input type="text" value="active"/>
Heating/Cooling requirement depending on	<input type="radio"/> valve status <input checked="" type="radio"/> control value
<hr/>	
i Outputs are switched on with a time delay.	
<hr/>	
Behavior after bus power return	
Request control/temperature values	<input type="radio"/> not active <input checked="" type="radio"/> active
Summer/Winter	<input type="text" value="restore state"/>
<hr/>	
Language for diagnosis text	<input checked="" type="radio"/> German <input type="radio"/> English

Figure 4: General settings

The individual settings are described in detail below.

4.1.1 Device configuration

The following parameters are used for the basic configuration of the device:

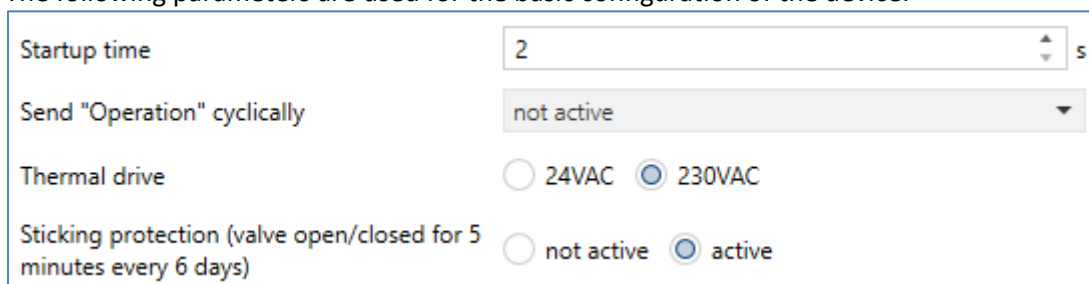

The screenshot shows a configuration window with the following settings:

- Startup time:** 2 s
- Send "Operation" cyclically:** not active
- Thermal drive:** 230VAC (selected), 24VAC
- Sticking protection (valve open/closed for 5 minutes every 6 days):** active (selected), not active

Figure 5: Settings – Basic configuration

The following table shows the possible settings:

ETS-Text	Dynamic range [Default value]	Comment
Startup time	2 ... 240 s [2 s]	Time that elapses between bus voltage recovery and the start-up of the unit.
Send „Operation“ cyclically	not active 1 min – 24 h	Setting whether an “in operation” telegram should be sent cyclically.
Thermal drive	<ul style="list-style-type: none"> ▪ 24VAC ▪ 230VAC 	Setting the voltage on the thermal drives.
Sticking protection (all 6 days for 5min valve open/close)	<ul style="list-style-type: none"> ▪ not active ▪ active 	Activates the protection against valve sticking.

Table 3: Settings – Basic configuration

The device “**Startup time**” defines the time that elapses between a bus voltage recovery or an ETS download until the device itself starts. This is useful if, for example, one device is to start later than another, e.g., in order to obtain important values.

The parameter “**Send 'Operation' cyclically**” causes telegrams to be sent on the bus in the configured cycle if the unit is operating normally. If, for example, the unit fails and no longer transmits, this can be used for monitoring purposes and appropriate measures can be taken.

The voltage setting for the “**Thermal drive**” determines the supply voltage with which the thermal drive operates. The voltage setting only changes the fault detection in the actuator itself, otherwise the functions remain identical. In 230V operation, the fault function detects both a short circuit and a mains failure. In 24V operation, only the short circuit is detected. In the event of an active fault, a 1 signal is sent via the associated object. In addition, the affected channel reacts with a fast flashing of the associated channel LED.

(Flashing behaviour see [2.6 Error messages – Channel LEDs](#)).

Attention: Operating voltage for the heating actuator must be AC voltage.

TRIACs at the output cannot work with DC voltage!

To ensure that a valve that has not been opened for a longer period does not block, the heating actuator has a “**Sticking protection**” (valve protection). This controls all channels in a fixed cycle of 6 days for 5 min and thus completely opens all connected valves once. This ensures smooth opening and closing of the valves. A status message as to whether and when the sticking protection is active can be used via the respective "Send valve status" status object in the parameters for each channel.

The following table shows the available communication objects:

Number	Name	Length	Usage
*	Fault – At power failure / short circuit	1 Bit	Reporting an active fault
*	Central function – Operating	1 Bit	Sending an "in operation" telegram

Table 4: Communication objects – Basic configuration

* Objects for central functions are always at the end of the object list. Object numbers are therefore dependent on the number of channels of each unit. For example, the central function "Switchover Heating/Cooling" is object no. 163 for an AKH-0400.03, no. 243 for an AKH-0600.03 and no. 323 for an AKH-0800.03.

Difference of object numbers of 4-fold → 6-fold → 8-fold is **+80** each.

An active fault can be reset by pressing the programming button.



Attention: The 1st channel of the 4-fold actuator, as well as the 1st and 5th channel of the 8-fold actuator, or the 1st and 4th channel of the 6-fold actuator, must be assigned first, otherwise a fault will be output!

Attention: Each actuator can only be operated via one voltage, either 230VAC or 24VAC. A combination of both voltages on one actuator is not permitted!

Operating voltage for the heating actuator must be AC voltage. TRIACs at the output cannot work with a DC voltage!

4.1.2 Operating mode – Heating system – Heating/Cooling switchover

The following picture shows the possible settings:

Figure 6: Settings – Operating mode / Heating system / Switchover

The following table shows the possible settings:

ETS-Text	Dynamic range [Default value]	Comment
Selection: Operating mode	<ul style="list-style-type: none"> ▪ Heating ▪ Cooling ▪ Heating and Cooling 	Setting with which operating mode the control should work.
Set control value "Heating" to 0% during "Summer" mode	<ul style="list-style-type: none"> ▪ not active ▪ active 	Always sets the control value to 0% during "Summer mode". Only available in "Heating" or "Heating and cooling" mode.
Set control value "Cooling" to 0% during "Winter" mode	<ul style="list-style-type: none"> ▪ not active ▪ active 	Always sets the control value to 0% during "Winter mode". Only available with operating mode "Cooling" or "Heating and cooling".
The following parameters are only available for "Heating and cooling" and "2-pipe system":		
Selection: Heating system	<ul style="list-style-type: none"> ▪ 2 pipe / 1 circuit (Heating or Cooling) ▪ 4 pipe / 2 circuit (Heating and Cooling separately) 	Setting whether to work with one or two heating circuits. Only available in the "Heating and cooling" operating mode.
Switchover for Heating/Cooling	<ul style="list-style-type: none"> ▪ via object Summer/Winter ▪ via object Heating/Cooling ▪ automatic 	Setting for how to switch between the operating modes.
Send status object Heating/Cooling cyclically	<p style="text-align: center;">not active</p> <p>5, 10, 20, 30 min / 1 h / 2 h / 4 h</p>	Setting whether the status object for Heating/Cooling is to be sent cyclically.
Reference channel for automatic switchover Heating/Cooling (2-pipe system)	<p style="text-align: center;">Channel A – D / F / H [Channel A]</p> <p style="text-align: center;">Number of channels depending on the device type</p>	Definition of the reference channel. Only available with switchover for Heating/Cooling "automatic".

Table 5: Settings – Operating mode / Heating system / Switchover

The **selection of the operating mode** determines whether it is a pure Heating system, a pure Cooling system or a combined system for Heating and Cooling.

In a pure Heating or Cooling system, there is only one circuit that is used only for **Heating** or only for **Cooling**.

For the operating mode "**Heating and Cooling**", a distinction is made in the following between two heating systems:

2-pipe system: There is only one circuit for Heating and Cooling:

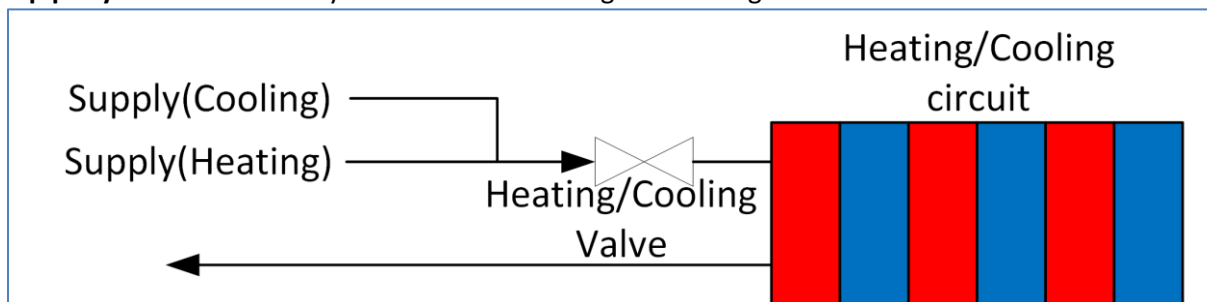

Figure 7: Diagram – 2 pipe system

In this setting, Heating and Cooling are locked against each other! Only Heating or Cooling mode is possible.

4-pipe system: There are 2 separate circuits for heating and cooling:

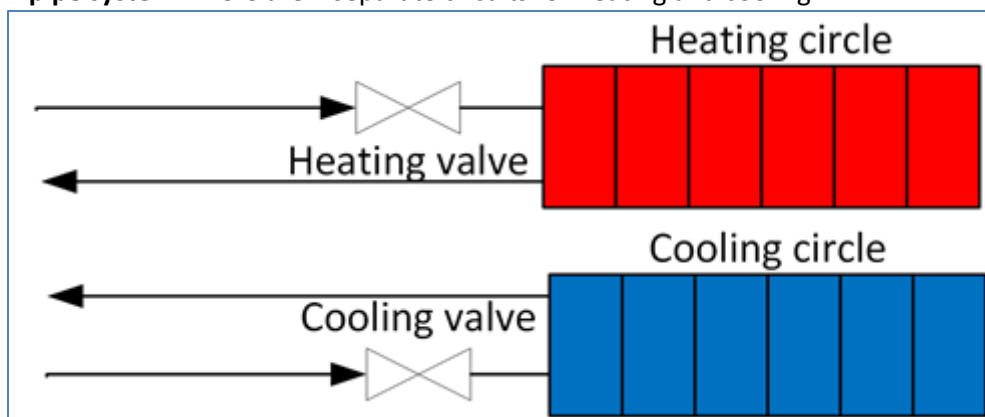

Figure 8: Diagram – 4 pipe system

In this setting, Heating and Cooling are not interlocked against each other. It is therefore possible to heat and cool at the same time, as there is a separate system. The definition of whether heating or cooling takes place is made via the control in the configuration in the respective channel.

Switchover for Heating/Cooling is only possible with the 2-pipe system. The switchover can be made via a separate **object "Heating/Cooling"**, via the **object "Summer/Winter"** or **"automatically"** via a **reference channel**.

With automatic switchover, the current state of the 2-pipe system is determined. For this, the reference channel must be set to "Heating and cooling (2-pipe system)".

The settings "**Set control value "Heating" to 0% during "Summer" mode**" and "**Set control value "Cooling" to 0% during "Winter" mode**" can be used to avoid opening the control valves in certain situations via the "Summer/Winter" object. In "Heating" mode, for example, it can be specified that no heating takes place during "Summer", although it would be possible on a cool day due to the temperature. Conversely, this also applies to cooling in "Winter" mode.

With the 4-pipe system, simultaneous heating and cooling can thus be avoided.

Attention: Only valid for "Channel → Basic Setting → Independent system → not active".
If "Independent system → active", the corresponding channel must be locked individually!

4.1.3 Summer/Winter mode

The Summer/Winter mode can be set with the following settings:

Determination of summer/winter	<input checked="" type="radio"/> via object	<input type="radio"/> automatic calculation
Polarity for object "Summer/Winter"	<input type="radio"/> Summer = 1 / Winter = 0	
	<input checked="" type="radio"/> Summer = 0 / Winter = 1	

Figure 9: Settings – Summer/Winter mode

The following table shows the possible settings:

ETS-Text	Dynamic range [Default value]	Comment
Determination of Summer/Winter	<ul style="list-style-type: none"> ▪ via object ▪ automatic calculation 	Specifying the way in which "Summer and Winter Operation" are determined
Polarity for object „Summer/Winter“	<ul style="list-style-type: none"> ▪ Summer = 1 / Winter = 0 ▪ Summer = 0 / Winter = 1 	Setting the polarity for the switchover.
Temperature threshold Winter -> Summer	10 ... 25 °C [16 °C]	Setting of the threshold at which the switchover takes place. Only for determination via "automatic calculation".
Reaction speed	<ul style="list-style-type: none"> ▪ fast ▪ medium ▪ slow 	Setting the reaction time to the temperature threshold. Only for determination via "automatic calculation".

Table 6: Settings – Summer/Winter mode

When "**Determination of Summer/Winter**" with the setting "**via object**", the "Summer-" or "Winter operation" is determined by means of the object "Summer/Winter - switchover". The determination of the **polarity** determines which value "Summer" and "Winter" correspond to. This is subsequently important, for example, to switch to "Summer" or "Winter" mode via object with a "1" or a "0".

With the "**automatic calculation**" setting, operation is determined by means of a temperature threshold. For the automatic calculation of "Summer/Winter", the time, date and outside temperature are required!

The **reaction speed** is divided as follows:

- fast
- medium
- slow

With "automatic calculation", the communication object "Summer/Winter override for 7 days" also appears. This can be used to force a fixed operation in "Summer" or "Winter" mode for 7 days, regardless of the temperature threshold. After the time has elapsed, the actuator switches to the current operation.

If the polarity is set to "Summer = 1 / Winter = 0", for example, a "1" switches to "Summer" operation, a "0" switches to "Winter" operation.

The following table shows the available communication objects:

Number	Name	Length	Usage
*	Summer/Winter – Switchover	1 Bit	Switching between Summer/Winter operation
*	Summer=x/Winter=x – Summer/Winter override for 7 days	1 Bit	This object can be used to set a fixed operation for a period of 7 days
*	Sommer=x/Winter=x – Status	1 Bit	Sending the current status
*	Lead value (Outside temperature) – Receive measured value	2 Byte	Receiving a temperature measurement value
*	Time – Receive current value	3 Byte	Receiving the time
*	Date – Receive current value	3 Byte	Receiving the date
*	Time / Date – Receive current value	8 Byte	Receiving the time and date

Table 7: Communication objects – Summer/Winter mode

* Objects for central functions are always at the end of the object list. Object numbers are therefore dependent on the number of channels of each unit. For example, the central function "Summer/Winter switchover" is object no. 161 for an AKH-0400.03, no. 241 for an AKH-0600.03 and no. 321 for an AKH-0800.03.

Difference of object numbers of 4-fold → 6-fold → 8-fold is **+80** each.

4.1.4 Setpoint Frost/Heat protection

The setpoints for Frost/Heat protection can be freely set:

Setpoint Frost protection for all channels	<input type="text" value="7"/>	°C
Setpoint Heat protection for all channels	<input type="text" value="35"/>	°C

Figure 10: Settings – Setpoints Frost/Heat protection

The set values basically apply to all channels. In the channels, however, it is also possible to adjust the values individually.

The following table shows the available settings:

ETS-Text	Dynamic range [Default value]	Comment
Setpoint Frost protection for all channels	7° ... 14 °C [7°C]	Setting of the setpoint for the operating mode "Frost protection". Valid for all channels. Parameter available in the operating mode "Heating" or "Heating and Cooling".
Setpoint Heat protection for all channels	24 ... 40 °C [35 °C]	Setting of the setpoint for the operating mode "Heat protection". Valid for all channels. Parameter available in the operating mode "Cooling" or "Heating and Cooling".

Table 8: Settings – Setpoints Frost/Heat protection

4.1.5 Object max. control value

The following picture shows the possible settings:

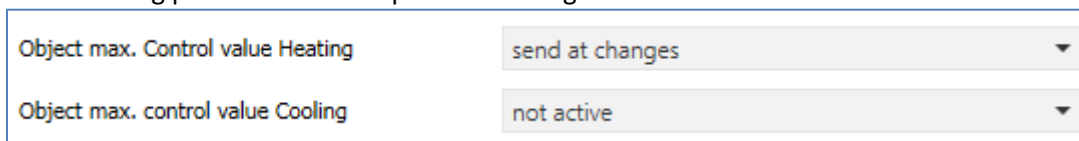

Figure 11: Settings – Object max. control value

The following table shows the available settings:

ETS-Text	Dynamic range [Default value]	Comment
Object max. control value Heating / Cooling	<ul style="list-style-type: none"> ▪ not active ▪ send on change ▪ send on change and send cyclically 30 min 	Activates the objects for the max. control value and defines their transmission behaviour. Available according to the selected operating mode (Heating and/or Cooling).

Table 9: Settings – Object max. control value

The parameters "Object max. control value Heating" and "Object max. control value Cooling" can be used to determine whether an object with the maximum control value of all channels is output. If this parameter is activated, two objects are displayed, which are shown in the table below. The maximum control value is sent either only in the event of a change or in the event of a change and cyclically every 30 minutes.

This function enables heaters/coolers that can modulate the output to be throttled accordingly when the heating/cooling demand is low. The object for the output sends the maximum control value required in the heating actuator for the channels in which this function was activated. The output signal can then be evaluated, and the required power passed on to the heating/cooling.

If several heating actuators have been installed, which all draw their heating power from one heating system, they can be linked together by the additional object for the input. The output of the first actuator is thereby connected to the input of the second actuator, i.e. stored in a common group address, etc. The output object for the maximum control value of the last heating actuator then indicates the maximum control value over all relevant channels.

The following table shows the available communication objects:

Number	Name	Length	Usage
*	Max. control value (Heating) – Output	1 Byte	Sends the current maximum control value
*	Max. control value (Heating) – Input	1 Byte	Receiving the current maximum control value
*	Max. control value (Cooling) – Output	1 Byte	Sends the current maximum control value
*	Max. control value (Cooling) – Input	1 Byte	Receiving the current maximum control value

Table 10: Communication objects – Object max. control value

* Objects for central functions are always at the end of the object list. Object numbers are therefore dependent on the number of channels of each unit. For example, the central function "Summer/Winter switchover" is object no. 161 for an AKH-0400.03, no. 241 for an AKH-0600.03 and no. 321 for an AKH-0800.03.

Difference of object numbers of 4-fold → 6-fold → 8-fold is **+80** each.

4.1.6 Requirement for Heating/Cooling

The following picture shows the possible settings:

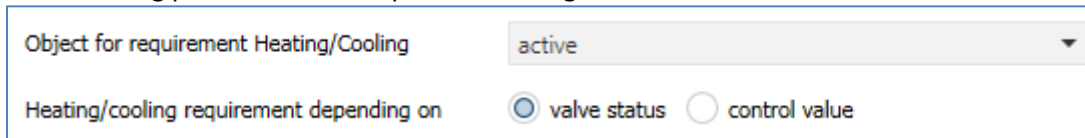

Figure 12: Settings – Requirement for Heating/Cooling

The following table shows the available settings:

ETS-Text	Dynamic range [Default value]	Comment
Object for requirement Heating/Cooling	<ul style="list-style-type: none"> ▪ not active ▪ active ▪ active with 10 min power off delay ▪ active with 20 min switch-off delay ▪ active with 30 min switch-off delay 	Activation of the Heating/Cooling requirement object and setting of a possible switch-off delay.
Heating/Cooling requirement depending on	<ul style="list-style-type: none"> ▪ valve status ▪ control value 	Setting on which status/value the requirement reacts.

Table 11: Settings – Requirement for Heating/Cooling

As soon as a channel of the Heating Actuator, which has been activated in the "Output" channel menu the parameter "Consider channel in Heating/Cooling requirement and max. control value", is energised, a "1" is output on the object for the Heating and/or Cooling requirement. This means that the heating circuit pump can be switched on, for example. If no channel is energised, a "0" is sent.

You can choose between two dependencies:

Valve status: The requirement switches to "0" when no valve is energised, i.e. also in the PWM pause. In this case, the outputs are switched on simultaneously.

Control value: The requirement only switches to "0" when all control values are at 0%. In this case, the outputs are switched on with a time delay.

Important: The "valve status" setting does not include the max. control value object.

The Heating/Cooling requirement sends cyclically every 30min. This time is fixed internally and cannot be adjusted.

The following table shows the available communication objects:

Number	Name	Length	Usage
*	Heating requirement – 0 if all valves closed, else 1	1 Bit	Sending a heating requirement. Only for “Heating” or “Heating/Cooling” (4-pipe system). Depending on valve status.
*	Heating/Cooling requirement – 0 if all valves closed, else 1	1 Bit	Sending a common heating/cooling requirement (for 2-pipe system). Depending on valve status.
*	Cooling requirement – 0 if all valves closed, else 1	1 Bit	Sending a cooling requirement. Only for “Cooling” or “Heating/Cooling” (4-pipe system). Depending on valve status.
*	Heating requirement – 0 if control value = 0%, else 1	1 Bit	Sending a heating requirement. Only for “Heating” or “Heating/Cooling” (4-pipe system). Depending on control value.
*	Heating/Cooling requirement – 0 if control value = 0%, else 1	1 Bit	Sending a common heating/cooling requirement (for 2-pipe system). Depending on control value.
*	Cooling requirement – 0 if control value = 0%, else 1	1 Bit	Sending a cooling requirement. Only for “Cooling” or “Heating/Cooling” (4-pipe system). Depending on control value.

Table 12: Communication objects – Requirement for Heating/Cooling

* Objects for central functions are always at the end of the object list. Object numbers are therefore dependent on the number of channels of each unit. For example, the central function "Summer/Winter switchover" is object no. 161 for an AKH-0400.03, no. 241 for an AKH-0600.03 and no. 321 for an AKH-0800.03.

Difference of object numbers of 4-fold → 6-fold → 8-fold is **+80** each.

4.1.7 Behaviour after bus power return

The following picture shows the possible settings:

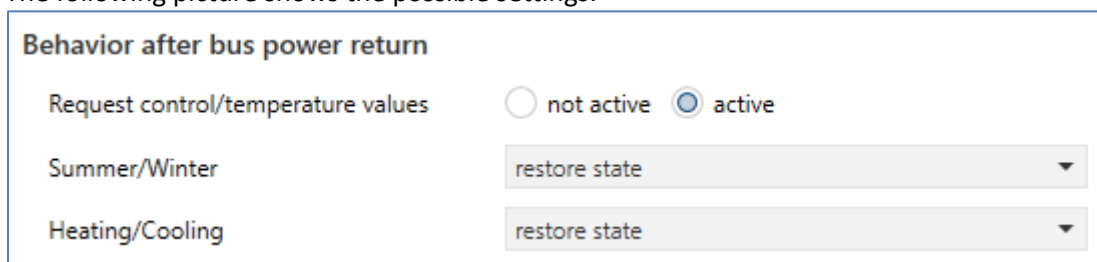

Figure 13: Settings – Behaviour after bus power reset

The following table shows the available settings:

ETS-Text	Dynamic range [Default value]	Comment
Query control/temperature values	<ul style="list-style-type: none"> ▪ not active ▪ active 	Setting whether the values are to be actively requested after bus voltage return.
Summer/Winter	<ul style="list-style-type: none"> ▪ Winter mode ▪ Summer mode ▪ request object „Summer/Winter“ ▪ restore state 	Determining the setting after bus power return for “Summer/Winter”.
Heating/Cooling	<ul style="list-style-type: none"> ▪ Heating ▪ Cooling ▪ request object „Heating/Cooling“ ▪ restore state 	Defines the setting after bus power return for "Heating/Cooling". Only available for "Heating and cooling", "2-pipe system" and Heating/cooling switchover "via Heating/Cooling object".

Table 13: Settings – Behaviour after bus power reset

The "**Behaviour after bus voltage return**" can be used to define how the actuator should behave in this case.

The first parameter can be used to request control values and temperature values. The "Summer/Winter" parameter determines whether the actuator starts in Summer or Winter mode, whether the "Summer/Winter" object is requested or whether it should start in the state before bus voltage failure.

If the actuator is set to "Heating and Cooling mode, 2-pipe system" and is switched over at the same time via the "Heating/Cooling object", a corresponding behaviour for "Heating/Cooling" can also be defined here.

Further settings for the behaviour after reset can be made in the individual channels.

Note: The state is only restored when the bus voltage returns. When the unit is reprogrammed, "Winter" mode and "Heating" are activated (exception: Global system = "Cooling" only).

4.1.8 Language for diagnosis text

The language for the diagnosis text can be set in the general settings:



Figure 14: Setting – Language for diagnosis text

The activation and the corresponding sending condition for the output of a diagnosis text can be set individually for each channel in the "Output" menu of the corresponding channel. The diagnosis function outputs the status of each individual channel in "plain text" and is used to quickly read off the current status of the channel.

4.1.8.1 Diagnosis texts as plain text

The following messages can be sent out by the diagnosis function:

Info	Byte 0-1	Byte 3	Byte 5-11	Byte 13
	Summer /Winter	Heating/ Cooling	Operating Mode	Control value > 0 % If yes: Value = 1
Possible indications				
	Winter: Wi	Heating: H	Comfort	Control value = 0 %: 0
	Summer: Su	Cooling: C	Standby	Control value >0 %: 1
			Night	
			Frost	
			Heat	
			ComProl: Comfort prolongation	
			Mode C: Channel is set to Cooling mode but actuator is in Heating mode	
			Mode H: Channel is set to Heating mode but actuator is in Cooling mode	
			Mode ER: Channel is set to different Heating system than configured in "general settings"	
			BIT: Channel set to switching 1 Bit	
			PWM BYTE: Channel is set to continuous 1Byte	
Special reports				
Locked	Channel is locked			
Window	Window is open			
Emergency	Channel is in Emergency Mode			
Forced	Channel is in the forced position			
Dewpointalarm	Dew point alarm is active			
H=0% (Summer)	Heating locked during Summer-operation			
C=0% (Winter)	Cooling locked during Winter-operation			
No Tempval	Temperature value is missing as input on the channel. Controller inactive			
No Controlval	Control value missing as input on channel. Output inactive			
No H/C Info	Channel is set to 2-pipe system, but no switching between Heating/Cooling is set.			
230V Error	No 230V are connected to the channel group. The 230V is always checked in groups - for channels 1-4 at channel 1, for channels 5-8 at channel 5.			
Load Error	Short circuit detected			
Testmode	Device in test mode			
Warnings				
Setpoint Guide	Reference control via outside temperature is active			
Contr Flowtemp	Control value changed by flow temperature limitation			
Contr Dewpoint	Control value changed by dew point			

Table 14: Overview – Diagnosis text as plain text

"Warnings" are an indication that certain actions are currently active. These are sent cyclically every 1 minute in addition to the normal analysis data.

4.2 Channel selection

The following picture shows the available settings, here for the AKH-0400.03:

Channel A	active
Channel B	active
Channel C	not active
Channel D	not active

Figure 15: Settings – Channel selection

The following table shows the available settings:

ETS-Text	Dynamic range [Default value]	Comment
Channel A – D / F / H	<ul style="list-style-type: none"> ▪ not active ▪ active ▪ active, control value from channel A ▪ active, control value from channel B ▪ : ▪ active, control value from channel X 	<p>Activation and setting of the channels.</p> <p>Number of setting options "active, control value of channel X" depending on the device type.</p>
Electrical output operating mode	<ul style="list-style-type: none"> ▪ Heating ▪ Cooling 	<p>Parameter visible when: Channel selection "active, control value of channel X" and "General setting" -> Heating and cooling -> 4-pipe system.</p>

Table 15: Settings – Channel selection

With this setting, the corresponding channels are activated. A separate menu then opens for the activated channel, in which the further configuration is carried out.

With the setting "**active**", the channel is then completely freely configurable.

With a setting of "**active, control value of channel X**", the channel takes over the control value of the other channel. This happens internally. Only the valve type and the object for the valve status can be set in the menu of the selected channel and only one object is available.

This setting is useful, for example, in very large rooms with many heating circuits for which several actuator channels are required. Only one channel is configured, which significantly minimises the configuration effort.

„**Electrical output operating mode**“ is available for selection if the channel from which the control value comes is configured to "Heating and Cooling" in a 4-pipe system (separate circuits). In this case, there is one control value for "Heating" and one control value for "Cooling". The control value for "Heating" is taken over by the controlling channel itself, the control value for "Cooling" is assigned to a second channel. The second channel then indicates whether it is for Heating or Cooling.

Example:

Channel A is configured for "Heating and Cooling", 4-pipe system. Channel A takes over the heating. Channel B is configured via the channel selection as "active, control value of channel A". In this case, the "Electrical output operating mode" is set to "Cooling".

Through this configuration, the control values are connected internally, group addresses and links are no longer necessary.

4.3 Channel – Basic setting

4.3.1 Identical settings: Description of channel/objects & Additional text

For each channel, two text fields are available for free labelling:

Description of channel/objects	Kitchen
Additional text	Heater, left

Figure 16: Settings – Text fields per channel

Texts with up to 30 characters can be stored for the field "**Description of channel/objects**", texts with up to 80 characters can be stored for the field "**Additional text**".

The text entered for "Description of channel/objects" appears both in the menu for the channel and in the communication objects of the channels.

Channel selection	
– Channel A: Kitchen	

1	Channel A: Kitchen	Receive temperature value
2	Channel A: Kitchen	Preset setpoint

The "**Additional text**" is merely additional information for the programmer. This text is not visible anywhere else.

4.3.1 Channel basic setting – Control mode

Before the configuration of the channel can be started, the control type of the channel must be selected. The control type of a channel depends on the object to be processed for the control value. The control type "switching (1bit)" processes 1-bit values that only send the two states "0" and "1". These control values are usually sent by 2-point controllers or control values that have already been converted to PWM. If a continuous input signal is available, e.g., a PI control, the control type "continuous (1byte)" must be selected. If only one temperature value is available, it can be processed further under the setting "integrated controller". With this selection, the complete control is carried out in the actuator channel itself.

Note: The basic setting of a channel can - depending on the configuration in the "General Setting" menu - turn out very differently. This is described in more detail in the following chapters.

The following picture shows the corresponding parameter for the setting in the "Basic setting" menu:

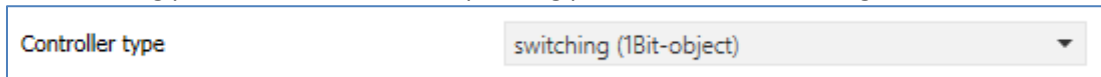

Figure 17: Setting – Controller type

The following table shows the available settings:

ETS-Text	Dynamic range [Default value]	Comment
Controller type	<ul style="list-style-type: none"> ▪ switching (1Bit object) ▪ continuous (1Byte object) ▪ integrated controller 	Selection of the control mode with which the channel is to operate.

Table 16: Settings – Controller type

Switching (1Bit object):

Channel is "passive" and receives an external control value as a 1Bit value.

Continuous (1Byte object):

Channel is "passive" and receives an external control value as a 1Byte value.

Integrated controller:

Channel is "active" controller and receives an external temperature value.

All controller settings are made in the channel.

4.4 Channel Configuration – Switching (1 Bit)

4.4.1 Basic setting

The following picture shows the possible settings:

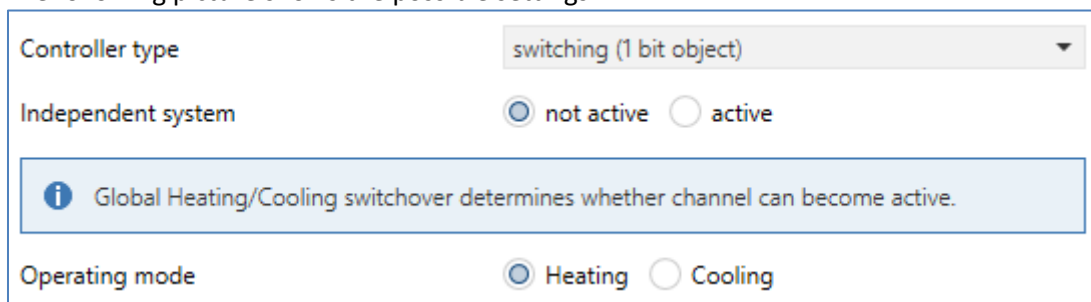

Figure 18: Basic settings – Controller type “switching 1 Bit”

The following table shows the available settings:

ETS-Text	Dynamic range [Default value]	Comment
Operating mode	<ul style="list-style-type: none"> ▪ Heating ▪ Cooling 	Selection of the operating mode for the channel.
Independent system	<ul style="list-style-type: none"> ▪ not active ▪ active 	Setting whether the channel reacts to the global "Heating/Cooling" switchover or can operate individually.

Table 17: Basic settings – Controller type “switching 1 Bit”

The selection of the **operating mode** can vary depending on the "Operating mode selection" in the "General setting" menu.

If the parameter "Operating mode selection" there is set to "Heating and Cooling", it is possible to select between "Heating" and "Cooling" in the basic setting for the channel.

If the "Operating mode selection" parameter is set to "Heating" only, the operating mode is fixed to "Heating". The same applies to "Cooling" only.

The "**Independent system**" setting can be used to determine whether the channel is oriented to the global switchover of heating and cooling (setting "not active") or can be controlled individually.

If the setting is "active", the channel can independently either "heat" or "cool".

Example:

General setting: "Heating and Cooling" for "2 pipe system".
Switchover Heating/Cooling to "Heating"

Channel: "Independent system -> active", operating mode: "Cooling".

Heating is used everywhere in the house, but cooling is to be continued in only one room.

Accordingly, a separate cooling system is also available there.

4.4.2 Output

The following settings are available in the "Output" menu of the channel (Here for operating mode "Heating"):

Valve type	<input checked="" type="radio"/> normally closed <input type="radio"/> normally opened
Send valve status cyclically	5 min
Consider channel in Heating/Cooling requirement and max. control value	<input type="radio"/> not active <input checked="" type="radio"/> active
Forced position	<input type="radio"/> not active <input checked="" type="radio"/> active
Control value for forced position	50%
Emergency mode	<input type="radio"/> not active <input checked="" type="radio"/> active
Emergency mode on failure of control value after...	30 Minutes
Control value for emergency mode	50%
Lock object for control value Heating	not active
Send diagnosis text	not active

Figure 19: Settings – Channel: Output (switching 1 Bit)

4.4.2.1 General settings

At the beginning, some basic settings are made:

ETS-Text	Dynamic range [Default value]	Comment
Valve type	<ul style="list-style-type: none"> ▪ normally closed ▪ normally opened 	Setting of the type of valve.
Send valve status cyclically	not active 1 min – 60 min [5 min]	Setting a repetition time for sending a telegram.
Consider channel in Heating/Cooling requirement and maximum control value	<ul style="list-style-type: none"> ▪ not active ▪ active 	Configuration of whether the channel is included in the calculation of the max. control value and the Heating/Cooling requirement.

Table 18: Settings – Channel: General

The "**Valve type**" setting is used to configure the output so that it passes on the correct voltage states to the control valve for the respective switching states of the output. This is only an adjustment to normally open/normally closed contacts. The output signal is inverted when the setting is " normally opened ".

With the parameter "**Send valve status cyclically**", a time interval can be defined when activated, in which the current status is sent on the bus.

The following communication object is available for this purpose:

Number	Name	Length	Usage
15	Send valve status: 1=open, 0=closed	1 Bit	Sending the current valve status

Table 19: Communication object – Send valve state

Furthermore, you can set whether the channel is considered in the menu “general settings” for the **Heating/Cooling requirement and the maximum control value**. If this setting is activated, the actuator takes this channel into account when calculating the maximum control value and the Heating/Cooling requirement.

4.4.2.2 Forced position/Dew point alarm

A forced position (in Heating- and Cooling mode) or a dew point alarm (only in Cooling mode) can be activated for each channel.

The following table shows the relevant settings:

ETS-Text	Dynamic range [Default value]	Comment
Forced position	<ul style="list-style-type: none"> ▪ not active ▪ active 	Activation of a forced position. Only available with "Heating" .
Forced position/ Dew point alarm	<ul style="list-style-type: none"> ▪ not active ▪ Forced position ▪ Dew point alarm (control value = 0%) 	Setting whether a forced position or dew point alarm is to be activated. Only available with "Cooling" .
Control value for forced position	0 – 100 % [0 %]	Setting of a fixed actuating value when forced position has been activated.

Table 20: Settings – Forced position/Dew point alarm

The **forced position** can set the control value to a fixed state with values from 0-100% when activated. The channel operates in an active forced position as a PWM controller with a fixed cycle time of 10 minutes. The forced position is activated by a "1" signal" to the associated object. If a "0" is sent, the channel falls back into its old state or adopts the last received value for the control value.

The following communication object is available for this:

Number	Name	Length	Usage
32	Forced position	1 Bit	Activation/deactivation of the forced position

Table 21: Communication object – Forced position

If the channel is in the operating mode "Cooling", a **dew point alarm** can be activated.

By activating it, an additional object is displayed as shown in the table below. Sending a "1" activates the dew point alarm, thereby setting the control value permanently to 0%. A "0" deactivates the dew point alarm and the channel operates normally.

The following communication object is available for this:

Number	Name	Length	Usage
32	Dew point alarm	1 Bit	Activation/deactivation of the dew point alarm

Table 22: Communication object – Dew point alarm

4.4.2.3 Emergency mode

The following picture shows the possible settings:

ETS-Text	Dynamic range [Default value]	Comment
Emergency mode	<ul style="list-style-type: none"> ▪ not active ▪ active 	Activation/deactivation of emergency mode.
Emergency mode on failure of control value after...	30 ... 90 Minutes [30]	Setting from when emergency mode is to start.
Control value for emergency mode	0 – 100 % [50 %]	Setting a fixed control value while emergency mode is active.

Table 23: Settings – Emergency mode

Emergency mode can be activated for each channel. The setting "**Emergency mode on failure of the control value after...**" can be used to set from when emergency operation is to be activated. The input object for the control value needs a cyclical pulse. If this signal remains absent for the configured time, emergency operation is activated. A fixed "**control value for emergency mode**" of 0-100% can be set for this. The Heating Actuator operates in emergency mode in PWM mode with a fixed cycle time of 10 minutes. The corresponding status LED on the actuator signals emergency operation by flashing 2x - pause - flashing 2x etc.

Emergency mode prevents the heating from being permanently operated at 100%, for example, or from cooling down at low temperatures in the event of a temperature controller failure. As soon as a control value is received again, the channel leaves the emergency mode and continues to operate normally. The monitoring time starts again each time a control value is received.

4.4.2.4 Lock objects

For each channel, a lock object is available for the control value in heating mode and in cooling mode. These can be used either as lock or enable objects.

The following table shows the possible settings:

ETS-Text	Dynamic range [Default value]	Comment
Lock object for control value Heating	<ul style="list-style-type: none"> ▪ not active ▪ active, enable object ▪ active, lock object 	Activation of a lock or enable object for heating operation.
Lock object for control value Cooling	<ul style="list-style-type: none"> ▪ not active ▪ active, enable object ▪ active, lock object 	Activation of a lock or enable object for cooling operation.

Table 24: Settings – Lock objects

The respective channel can be locked against further operation by means of the **lock object**. Locking is triggered by sending a logical "1" to the lock object. The locking process is only cancelled again by sending a logical "0". When the locking function is activated, the channel is switched off (control value=0%). After deactivating the locking process, the channel returns to its original value. If telegrams are sent to the locked channel during an active locking process, this does not lead to any change. The channel assumes the value of the last telegram after the locking process is cancelled. When setting as an **enable object**, it is exactly the other way round. With a "1", normal operation is enabled, with a "0", the channel is locked.

Important: After a restart of the Heating Actuator, each channel is in normal operation, even if the object is configured as an enable object. Thus, the channel must receive a "0" first to be locked and then a "1" to be enabled.

The following communication objects are available for this:

Number	Name	Length	Usage
30	Lock object Heating: Lock control value	1 Bit	Activating/deactivating a lock
30	Enable object Heating: Enable control value	1 Bit	Activation/deactivation of an enablement
31	Lock object Cooling: Lock control value	1 Bit	Activating/deactivating a lock
31	Enable object Cooling: Enable control value	1 Bit	Activation/deactivation of an enablement

Table 25: Communication objects – Lock-/Enable objects

4.4.2.5 Send diagnosis text

The following table shows the available sending conditions for the diagnosis text:

ETS-Text	Dynamic range [Default value]	Comment
Send diagnosis text	<ul style="list-style-type: none"> ▪ not active ▪ send on request ▪ send on change 	Activation and definition of the sending condition for a diagnosis text via object.

Table 26: Settings – Diagnosis text

Each channel can send a diagnosis text about the current status. The sending condition can be defined.

The description of the diagnosis texts can be found under: [4.1.8.1 Diagnosis texts as plain text.](#)

The following communication object is available for this:

Number	Name	Length	Usage
28	Diagnosis status	14 Byte	Sending the diagnosis text

Table 27: Communication object – Diagnosis text

4.5 Channel Configuration – Continuous (1 Byte)

4.5.1 Basic setting

The following picture shows the possible settings:

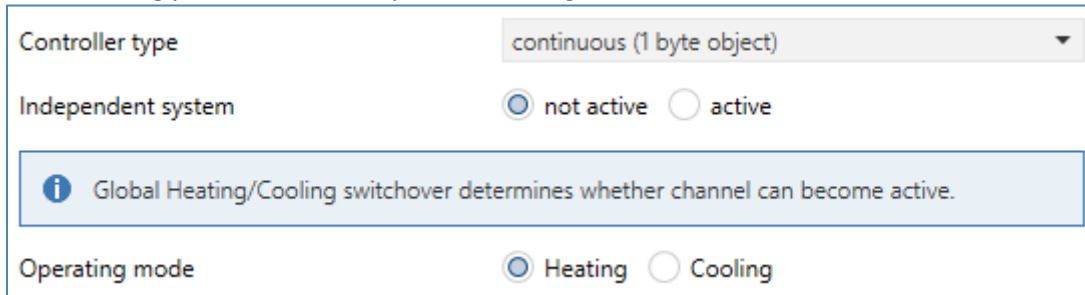

Figure 20: Basic settings – Controller type “continuous 1 Byte”

The following table shows the available settings:

ETS-Text	Dynamic range [Default value]	Comment
Operating mode	<ul style="list-style-type: none"> ▪ Heating ▪ Cooling 	Selection of the operating mode for the channel.
Independent system	<ul style="list-style-type: none"> ▪ not active ▪ active 	Setting whether the channel reacts to the global "Heating/Cooling" switchover or can operate individually.

Table 28: Basic settings – Controller type “continuous 1 Byte”

The selection of the **operating mode** can vary depending on the "Operating mode selection" in the "General setting" menu.

If the parameter "Operating mode selection" there is set to "Heating and Cooling", it is possible to select between "Heating" and "Cooling" in the basic setting for the channel.

If the "Operating mode selection" parameter is set to "Heating" only, the operating mode is fixed to "Heating". The same applies to "Cooling" only.

The "**Independent system**" setting can be used to determine whether the channel is oriented to the global switchover of heating and cooling (setting "not active") or can be controlled individually.

If the setting is "active", the channel can independently either "heat" or "cool".

Example:

General setting: "Heating and Cooling" for "2 pipe system".
Switchover Heating/Cooling to "Heating"

Channel: "Independent system -> active", operating mode "Cooling".

Heating is used everywhere in the house, but cooling is to be continued in only one room.

Accordingly, a separate cooling system is also available there.

4.5.2 Output

The following settings are available in the "Output" menu of the channel (Here for operating mode "Heating"):

Valve type	<input checked="" type="radio"/> normally closed <input type="radio"/> normally opened
PWM cycle time	10 min
Minimum limitation of control value	0%
Maximum limitation of control value	100%
Limitation via object	not active
Control value when falling below the minimum limitation	<input checked="" type="radio"/> 0% = 0%, otherwise use minimum set value <input type="radio"/> 0% = minimum set value
Send status of control value cyclically	5 min
Object valve status	<input checked="" type="radio"/> valve status (1=open, 0=closed) <input type="radio"/> 1, if control value > 0%
Consider channel in Heating/Cooling requirement and max. control value	<input type="radio"/> not active <input checked="" type="radio"/> active
Forced position	<input type="radio"/> not active <input checked="" type="radio"/> active
Control value for forced position	50%
Additional sensor for flow temperature	<input type="radio"/> not active <input checked="" type="radio"/> active
Maximum flow temperature Heating	40 °C
Minimum limit of flow temperature	<input checked="" type="radio"/> not active <input type="radio"/> active
Emergency mode	<input type="radio"/> not active <input checked="" type="radio"/> active
Emergency mode on failure of control value after...	30 Minutes
Control value for emergency mode	50%
Lock object for control value Heating	not active
Send diagnosis text	not active

Figure 21: Settings – Channel: Output (continuous 1 Byte)

4.5.2.1 General settings

At the beginning, some basic settings are made:

ETS-Text	Dynamic range [Default value]	Comment
Valve type	<ul style="list-style-type: none"> ▪ normally closed ▪ normally opened 	Setting of the type of valve.
Send status of control value cyclically	not active 1 min – 60 min [5 min]	Setting a repetition time for sending a telegram.
Consider channel in Heating/Cooling requirement and maximum control value	<ul style="list-style-type: none"> ▪ not active ▪ active 	Configuration of whether the channel is included in the calculation of the maximum control value and the Heating/Cooling requirement.

Table 29: Settings – Channel: General

The "**Valve type**" setting is used to configure the output so that it passes on the correct voltage states to the control valve for the respective switching states of the output. This is only an adjustment to normally closed/normally opened contacts. The output signal is inverted when the setting is "normally opened".

With the parameter "**Send status of control value cyclically**", a time interval can be defined when activated, in which the current status is sent on the bus.

The following communication objects are available for this purpose:

Number	Name	Length	Usage
12	Control value Heating: send status	1 Bit	Sending the current control value
13	Control value Cooling: send status	1 Bit	Sending the current control value

Table 30: Communication objects – Send valve state

Furthermore, you can set whether the channel is considered in the menu "general settings" for the **Heating/Cooling requirement and the maximum control value**. If this setting is activated, the actuator takes this channel into account when calculating the maximum control value and the Heating/Cooling requirement.

4.5.2.2 PWM cycle time

The setting "**PWM cycle time**" is used by the PWM control to calculate the switch-on and switch-off pulse of the control value. This calculation is based on the incoming control value. A PWM cycle comprises the total time that elapses from the switch-on point to the next switch-on point.

Example:

If a control value of 75% is calculated with a set cycle time of 10 minutes, the control value is switched on for 7.5 minutes and switched off for 2.5 minutes.

The setting options for the PWM cycle are shown in the following table:

ETS-Text	Dynamic range [Default value]	Comment
PWM cycle time	10 s – 30 min [10 min]	Setting the time for the duration of a PWM cycle.

Table 31: Settings – PWM cycle time

Basically, two different setting options have proven themselves. On the one hand, the setting where the valves can be completely opened and closed again within a complete cycle and, on the other hand, the setting where the cycle time is significantly shorter than the adjustment time of the valves and thus an average value is achieved.

The two setting options and their possible applications will be explained in more detail in the following sections. If several valves are to be controlled simultaneously, it is recommended to set according to the most inert system.

Option 1: Cycle time is larger than the adjustment time of the valves

This setting causes the valve to be completely opened and closed again within one cycle. During one cycle, the valve thus runs through the complete valve stroke.

The adjustment cycle time of a valve consists of a dead time (time that elapses between the activation of the valve and the opening process of the valve) and the actual adjustment time of the valve. The time in which the valve is actually open is therefore significantly shorter than the activation within a PWM cycle.

The principle of this option is shown at the diagram below:

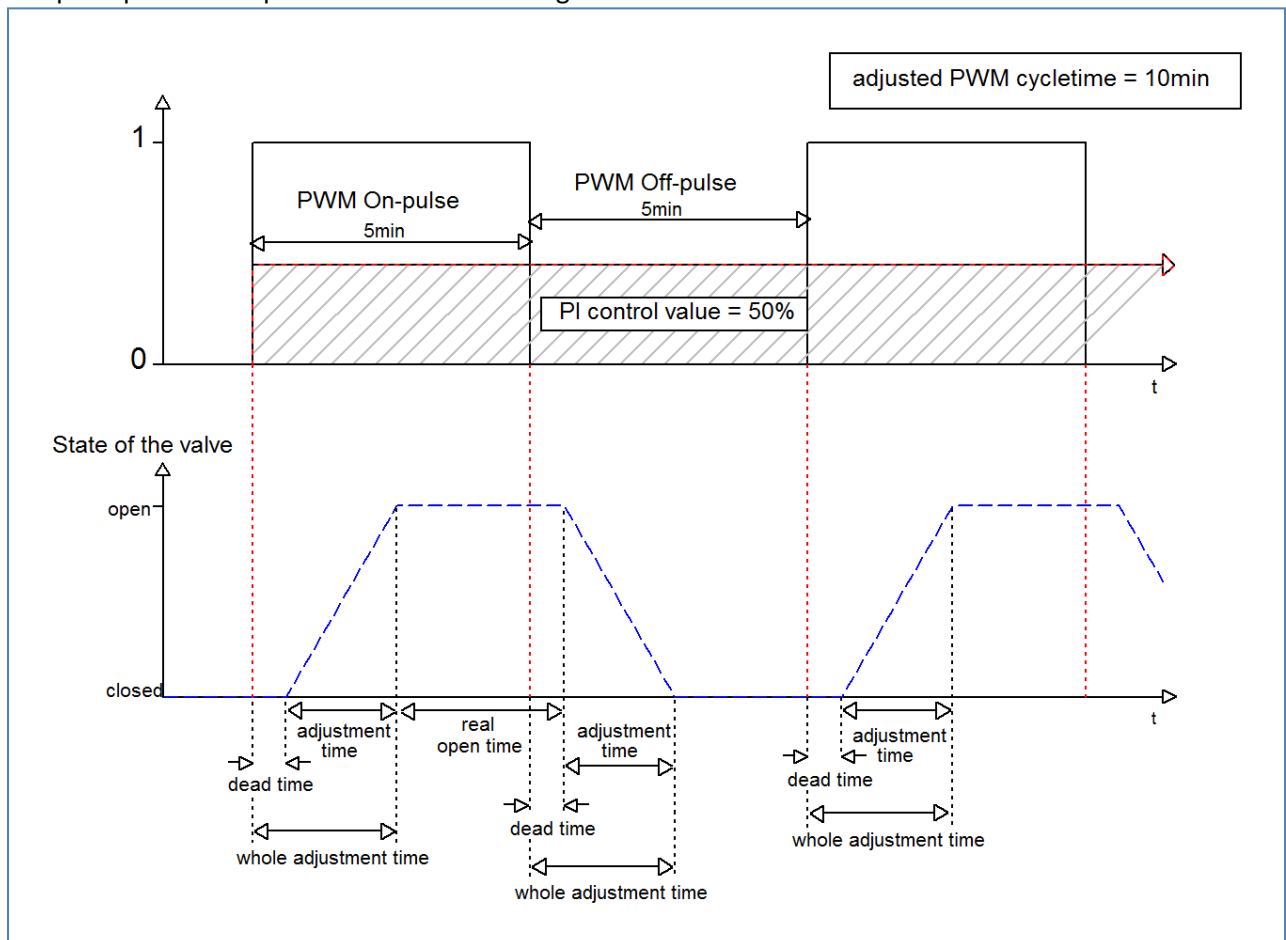

Figure 22: Diagram – PWM cycle time (1)

The total adjustment cycle time here is approximately 2.5-3 min, as is typically the case with valve drives for underfloor heating systems. By this adjustment cycle time, the valve is open for a shorter time than the PWM switch-on pulse is long or closed for a shorter time than the PWM switch-off pulse is long. Although this adjustment cycle time shortens both the actual opening time and the actual closing time, this method regulates the room temperature relatively accurately.

However, the complete opening/closing of the valves can also lead to greater fluctuations in the temperature in the immediate vicinity of the heat source. Furthermore, due to the relatively frequent opening and closing of the valves, they are also subjected to greater stress.

This setting has proven particularly useful for slower systems, such as underfloor heating systems.

Option 2: Cycle time is shorter than the adjustment time of the valves

This setting has the effect that the valve cannot open completely within the PWM switch-on pulse or switch-off pulse, but always goes through small movements. In the long term, this setting results in an average value for the opening of the valve.

The principle of this option is shown at the diagram below:

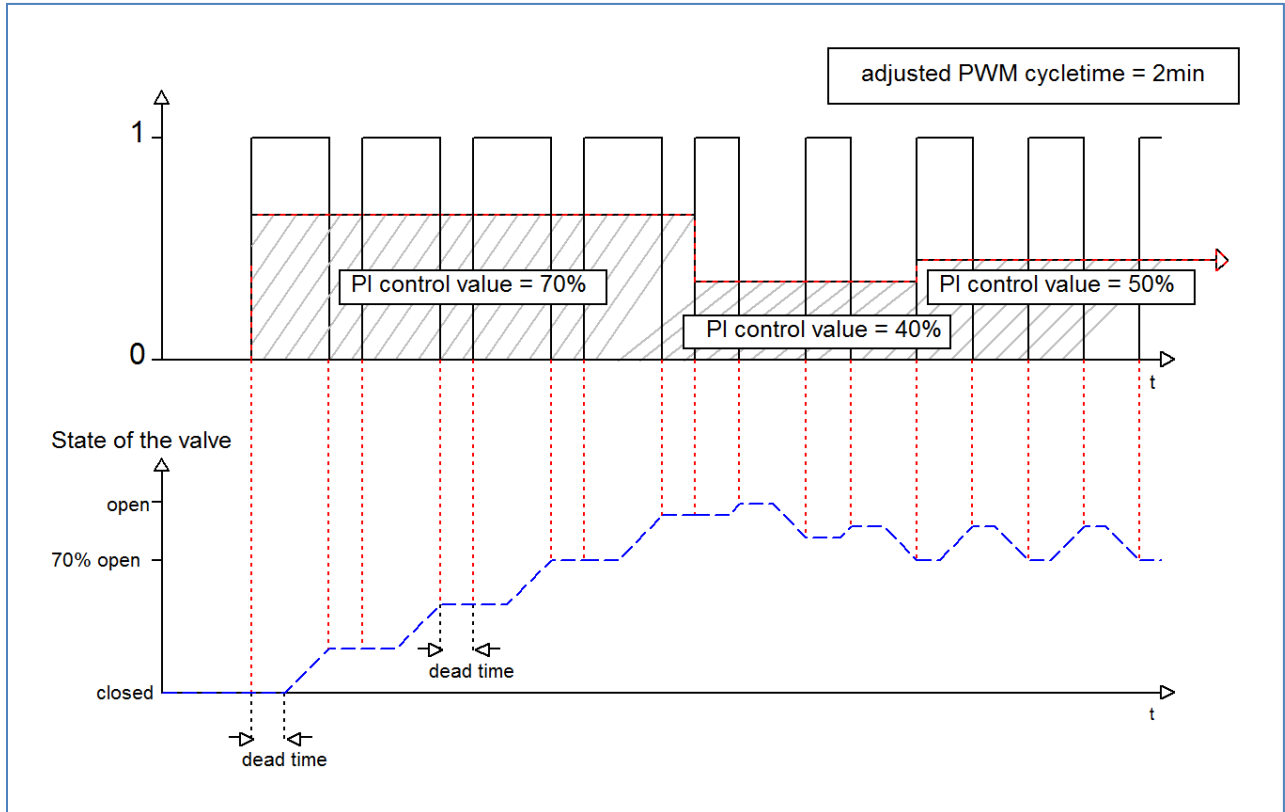

Figure 23: Diagram – PWM cycle time (2)

Here, too, the total adjustment cycle time is about 3 min. However, the valve can only make small deflections during the control and not the entire amplitude as in the previous settings. At the beginning, no movement takes place within the switch-off pulse of the PWM control, as the dead time of the valve here is just if the activation of the valve. This means that the valve continues to open continuously. If the temperature in the room exceeds the set value, the temperature controller readjusts the control value and thus the PWM pulse is set again. In the long term, this setting achieves an almost constant value for the valve position.

It should also be noted with this setting that the dead times will decrease due to the permanently flowing warm water in the control valve and thus the actual travel times will increase within the pulse. However, since the temperature controller reacts dynamically, it will respond to this change with a changed control value and thus also achieve an almost constant valve position. The advantage of this setting is that the control valves are not overloaded and the temperature in the room is hardly subject to fluctuations due to the continuous adjustment of the control value. However, if several valves are controlled, the average value for the valve position can hardly be achieved and thus fluctuations in the room temperature can occur.

This setting has become established especially in fast systems where only one control valve is controlled, e.g., radiators.

4.5.2.3 Limitation of control value

The following settings are available:

ETS-Text	Dynamic range [Default value]	Comment
Minimum limitation of control value	0 – 50% [0%]	Setting the minimum limitation of the control value.
Maximum limitation of control value	20 – 100% [100%]	Setting the maximum limitation of the control value.
Limitation via object	<ul style="list-style-type: none"> ▪ not active ▪ active for 1 h ▪ . ▪ . ▪ active for 24 h 	Activates an override of the minimum or maximum control value for a certain time.

Table 32: Settings – Limitation of control value

This parameter limits the value of the control value that is passed on to the PWM signal. With an active control value limitation, i.e., minimum>0% or maximum<100%, the input signal, insofar as it lies outside the limitation, is raised/lowered to the corresponding limit. The pulses for the PWM signal are then calculated from this value.

Example: In heating mode, the maximum limitation is set to 70% and the minimum limitation to 10%. The PWM cycle is 10 min. If a control value of 100% is sent, the channel assumes the maximum limitation of 70% and calculates the "switch-on pulse" of 7 min. A control value within the limitation behaves normally, i.e., a control value of 50% also leads to a "switch-on pulse" of 5 min.

The control value limitations can be set individually for Heating- and Cooling mode.

The minimum limitation of the control value is designed so that a control value of 0% is not limited and leads to a control value of 0%. Any control value above 0% but below the minimum limitation leads to the set value. This behaviour makes sense for reasons of energy saving, as otherwise the control valve would constantly consume the limitation value of the nominal power even when not in use.

With the setting "**Limitation via object**", two new objects are displayed. By sending a percentage value to the corresponding communication object, either the minimum or the maximum control value can be limited for the set time.

Example: In the morning, the floor heating in the bathroom is to be limited to a minimum of 30% for 1 hour. This means that the floor is "foot warm" for this time. After the time has elapsed, the configured limitation values apply again.

The following communication objects are available for this:

Number	Name	Length	Usage
33	Override: Minimum control value	1 Byte	Sending a control value for minimum limitation for a set time
34	Override: Maximum control value	1 Byte	Sending a control value for maximum limitation for a set time

Table 33: Communication objects – Limitation of control value

4.5.2.4 Control value when falling below the minimum limitation

The following table shows the available settings:

ETS-Text	Dynamic range [Default value]	Comment
Control value when falling below the minimum limitation	<ul style="list-style-type: none"> ▪ 0% = 0%, otherwise use minimum set value ▪ 0% = Use minimum set value 	Setting of what is to happen at a control value of 0%.

Table 34: Settings – Control value when falling below the minimum limitation

The parameter defines the behaviour when the channel receives a control value of 0%:

- **0% = 0%, otherwise use minimum set value**
When receiving a control value of 0%, the channel sets the channel to permanently off, i.e. the 0% is actually interpreted as this.
- **0% = Use minimum set value**
When a control value of 0% is received, the channel sets the channel to the set minimum control value. For example, if a control value of 0% is received and the minimum control value is set to 10%, the channel calls up the settings for 10%.

4.5.2.5 Object valve status

The following table shows the available settings:

ETS-Text	Dynamic range [Default value]	Comment
Object valve status	<ul style="list-style-type: none"> ▪ valve status (1=open, 0=closed) ▪ 1, if control value > 0% 	Setting how the valve status is displayed via object

Table 35: Settings – Object valve status

valve status (1=open, 0=closed)“:

In this setting, the actual valve status is sent via a 1-bit object.

Example:

PWM cycle 10 minutes

Control value 10%

Within the PWM cycle of 10 minutes, the valve status "1" is sent for 1 minute (=10%), and the valve status "0" for 9 minutes. Please note that the "1" does not appear at the beginning, but at some point, during the cycle.

1, if control value > 0%:

With this setting, a "1" is sent as soon as the incoming control value is greater than 0%. It is irrelevant whether the value is 1% or 100%. As soon as a control value with a value of "0%" is received, the status sends a "0".

The following communication objects are available for this:

Number	Name	Length	Usage
14	Control value > 0%: Send status	1 Bit	Sending the status
15	Send valve status: 1=open, 0=closed	1 Bit	Sending the status

Table 36: Communication objects – Object valve status

4.5.2.6 Forced position/Dew point alarm

A forced position (in Heating- and Cooling mode) or a dew point alarm (only in Cooling mode) can be activated for each channel.

The following table shows the relevant settings:

ETS-Text	Dynamic range [Default value]	Comment
Forced position	<ul style="list-style-type: none"> ▪ not active ▪ active 	Activation of a forced position. Only available with "Heating"
Forced position/ Dew point alarm	<ul style="list-style-type: none"> ▪ not active ▪ Forced position ▪ Dew point alarm (control value = 0%) 	Setting whether a forced position or dew point alarm is to be activated. Only available with "Cooling"
Control value for forced position	0 – 100 % [0 %]	Setting of a fixed actuating value when forced position has been activated

Table 37: Settings – Forced position/Dew point alarm

The **forced position** can set the control value to a fixed state with values from 0-100% when activated. The channel operates in an active forced position as a PWM controller with a fixed cycle time of 10 minutes. The forced position is activated by a "1" signal" to the associated object. If a "0" is sent, the channel falls back into its old state or adopts the last received value for the control value. The following communication object is available for this:

Number	Name	Length	Usage
32	Forced position	1 Bit	Activation/deactivation of the forced position

Table 38: Communication object – Forced position

If the channel is in the operating mode "Cooling", a **dew point alarm** can be activated.

By activating it, an additional object is displayed as shown in the table below. Sending a "1" activates the dew point alarm, thereby setting the control value permanently to 0%. A "0" deactivates the dew point alarm and the channel operates normally.

The following communication object is available for this:

Number	Name	Length	Usage
32	Dew point alarm	1 Bit	Activation/deactivation of the dew point alarm

Table 39: Communication object – Dew point alarm

4.5.2.7 Additional sensor for flow temperature

This parameter is only available in the "Heating" mode!

The following picture shows the possible settings:

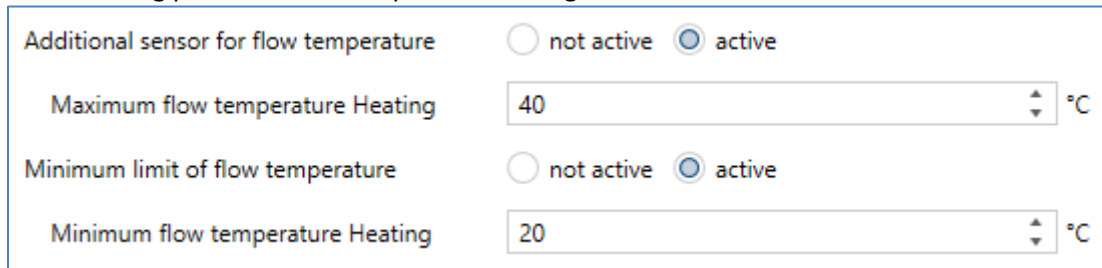

Additional sensor for flow temperature not active active

Maximum flow temperature Heating 40 °C

Minimum limit of flow temperature not active active

Minimum flow temperature Heating 20 °C

Figure 24: Settings – Additional sensor for flow temperature

The following table shows the relevant settings:

ETS-Text	Dynamic range [Default value]	Comment
Additional sensor for flow temperature	<ul style="list-style-type: none"> ▪ not active ▪ active 	Activation/deactivation of a flow temperature limitation
Maximum flow temperature Heating	0 ... 60°C [40°C]	Setting a maximum flow temperature
Minimum limit of flow temperature	<ul style="list-style-type: none"> ▪ not active ▪ active 	Activation/deactivation of the minimum flow temperature limitation
Minimum flow temperature Heating	0 ... 60°C [20°C]	Setting a minimum flow temperature

Table 40: Settings – Additional sensor for flow temperature

With this parameter, the current flow temperature can be limited. This makes it possible to limit the heating temperature as required in certain situations. If, for example, a floor heating system is not to heat above a certain value to protect the floor coverings, the heating temperature can be limited by the maximum flow temperature.

The minimum flow limitation can be used, for example, to keep the bathroom floor at a comfortable temperature.

The flow temperature limitation requires a second sensor that is installed in the floor/screed and detects the floor temperature.

The following communication object is available for this purpose:

Number	Name	Length	Usage
26	Receive flow temperature heating	2 Byte	Input of an external temperature reading

Table 41: Communication object – Additional sensor for flow temperature

4.5.2.8 Additional sensor for cooling medium

This parameter is only available in the "Cooling" operating mode!

The following settings are available:

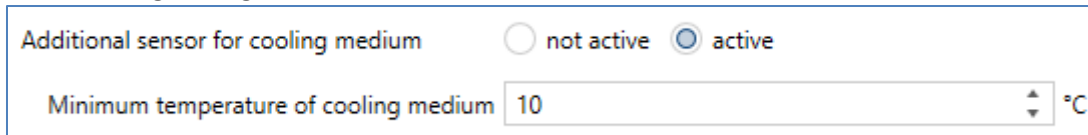

Additional sensor for cooling medium not active active

Minimum temperature of cooling medium 10 °C

Figure 25: Settings – Additional sensor for cooling medium

The following table shows the possible settings:

ETS-Text	Dynamic range [Default value]	Comment
Additional sensor for cooling medium	<ul style="list-style-type: none"> ▪ not active ▪ active 	Activation of an additional sensor.
Minimum temperature of cooling medium	0 ... 60°C [10°C]	Setting a minimum temperature.

Table 42: Settings – Additional sensor for cooling medium

This parameter determines the temperature threshold above which the control value of the cooling channel is regulated back. This can prevent unwanted condensation. For this purpose, another temperature sensor is required, which is placed at the coolest point of the air conditioner.

The following communication object is available:

Number	Name	Length	Usage
27	Receive surface temperature Cooling	2 Byte	Input of an external temperature reading

Table 43: Communication object – Additional sensor for cooling medium

4.5.2.9 Emergency mode

The following picture shows the possible settings:

ETS-Text	Dynamic range [Default value]	Comment
Emergency mode	<ul style="list-style-type: none"> ▪ not active ▪ active 	Activation/deactivation of emergency operation.
Emergency mode on failure of control value after...	30 ... 90 Minutes [30]	Setting from when emergency operation is to start.
Control value for emergency mode	0 – 100 % [50 %]	Setting a fixed control value while emergency operation is active.

Table 44: Settings – Emergency mode

Emergency mode can be activated for each channel. The setting "**Emergency mode on failure of the control value after**" can be used to set from when emergency operation is to be activated. The input object for the control value needs a cyclical pulse. If this signal remains absent for the configured time, emergency operation is activated. A fixed "**control value for emergency mode**" of 0-100% can be set for this. The Heating Actuator operates in emergency mode in PWM mode with a fixed cycle time of 10 minutes. The corresponding status LED on the actuator signals emergency operation by flashing 2x - pause - flashing 2x etc.

Emergency mode prevents the heating from being permanently operated at 100%, for example, or from cooling down at low temperatures in the event of a temperature controller failure. As soon as a control value is received again, the channel leaves the emergency mode and continues to operate normally. The monitoring time starts again each time a control value is received.

4.5.2.10 Lock objects

For each channel, a lock object is available for the control value in heating mode and in cooling mode. These can be used either as lock or enable objects.

The following table shows the possible settings:

ETS-Text	Dynamic range [Default value]	Comment
Lock object for control value Heating	<ul style="list-style-type: none"> ▪ not active ▪ active, enable object ▪ active, lock object 	Activation of a lock or enable object for heating operation.
Lock object for control value Cooling	<ul style="list-style-type: none"> ▪ not active ▪ active, enable object ▪ active, lock object 	Activation of a lock or enable object for cooling operation.

Table 45: Settings – Lock objects

The respective channel can be locked for further operation by means of the **lock object**. Locking is triggered by sending a logical "1" to the lock object. The locking process is only cancelled again by sending a logical "0". When the locking function is activated, the channel is switched off (control value=0%). After deactivating the locking process, the channel returns to its original value. If telegrams are sent to the locked channel during an active locking process, this does not lead to any change. The channel assumes the value of the last telegram after the locking process is cancelled.

When setting as an **enable object**, it is exactly the other way round. With a "1", normal operation is enabled, with a "0", the channel is locked.

Important: After a restart of the Heating Actuator, each channel is in normal operation, even if the object is configured as an enable object. Thus, the channel has to receive a "0" first to be locked and then a "1" to be enabled.

The following communication objects are available for this:

Number	Name	Length	Usage
30	Lock object Heating: Lock control value	1 Bit	Activating/deactivating a lock
30	Enable object Heating: Enable control value	1 Bit	Activation/deactivation of an enablement
31	Lock object Cooling: Lock control value	1 Bit	Activating/deactivating a lock
31	Enable object Cooling: Enable control value	1 Bit	Activation/deactivation of an enablement

Table 46: Communication objects – Lock-/Enable objects

4.5.2.11 Send diagnosis text

The following table shows the available sending conditions for the diagnosis text:

ETS-Text	Dynamic range [Default value]	Comment
Send diagnosis text	<ul style="list-style-type: none"> ▪ not active ▪ send on request ▪ send on change 	Activation and definition of the sending condition for a diagnosis text via object

Table 47: Settings – Diagnosis text

Each channel can send a diagnosis text about the current status. The sending condition can be defined.

The description of the diagnosis texts can be found under: [4.1.8.1 Diagnosis texts as plain text.](#)

The following communication object is available for this:

Number	Name	Length	Usage
28	Diagnosis status	1 Bit	Sending the diagnosis text

Table 48: Communication object – Diagnosis text

4.6 Channel Configuration – Integrated Controller

4.6.1 Basic setting

The following picture shows the basic settings in "General setting" → "Heating and Cooling" → "4-pipe system":

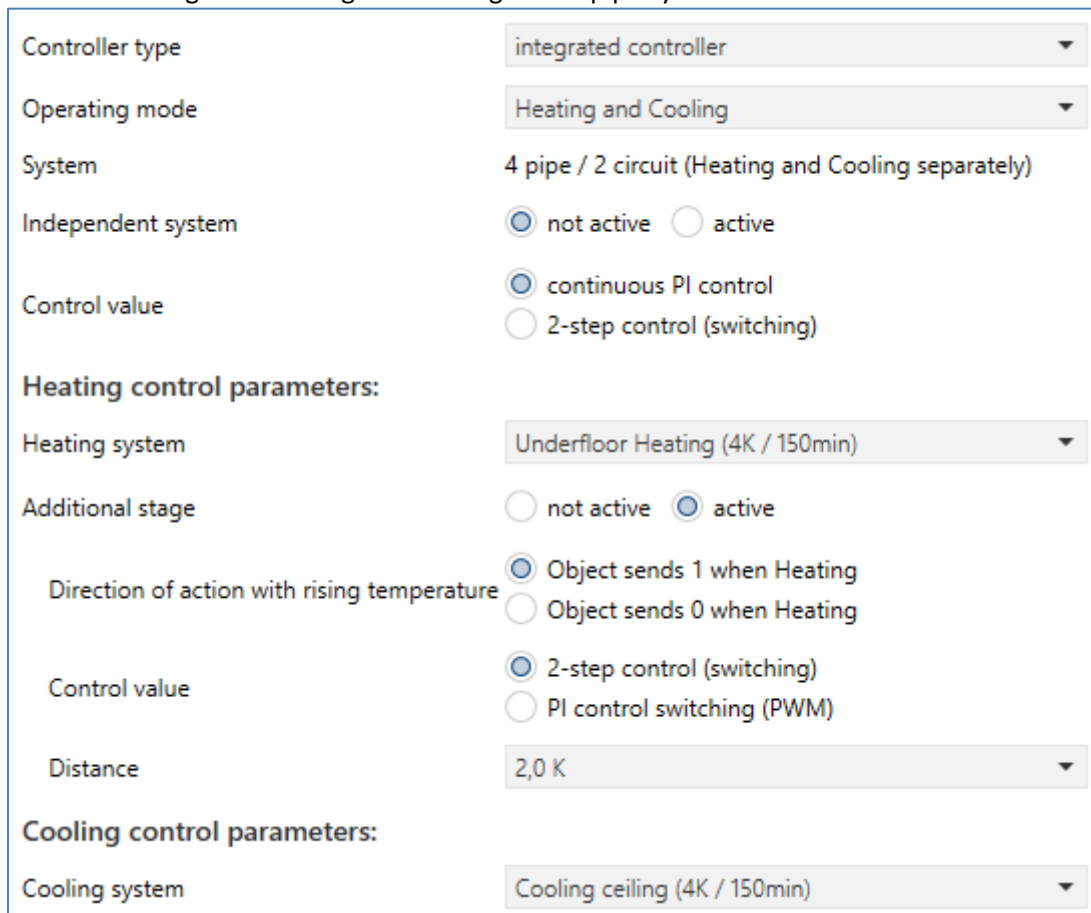

Controller type	integrated controller
Operating mode	Heating and Cooling
System	4 pipe / 2 circuit (Heating and Cooling separately)
Independent system	<input checked="" type="radio"/> not active <input type="radio"/> active
Control value	<input checked="" type="radio"/> continuous PI control <input type="radio"/> 2-step control (switching)
Heating control parameters:	
Heating system	Underfloor Heating (4K / 150min)
Additional stage	<input type="radio"/> not active <input checked="" type="radio"/> active
Direction of action with rising temperature	<input checked="" type="radio"/> Object sends 1 when Heating <input type="radio"/> Object sends 0 when Heating
Control value	<input checked="" type="radio"/> 2-step control (switching) <input type="radio"/> PI control switching (PWM)
Distance	2,0 K
Cooling control parameters:	
Cooling system	Cooling ceiling (4K / 150min)

Figure 26: Basic settings – Controller type “integrated controller”

The following table shows the possible settings:

ETS-Text	Dynamic range [Default value]	Comment
Controller type “integrated controller”		
Operating mode	<ul style="list-style-type: none"> ▪ Heating ▪ Cooling ▪ Heating and Cooling 	Selection of the operating mode for the channel.
System	- 2 pipe / 1 circuit (Heating or Cooling) or - 4 pipe / 2 circuit (Heating and Cooling separately)	Displayed text depends on the setting in the "General setting" menu. Only available in operating mode "Heating and Cooling".

Independent system	<ul style="list-style-type: none"> ▪ not active ▪ active 	Setting whether the channel reacts to the global "Heating/Cooling" switchover or can operate individually.
Control value	<ul style="list-style-type: none"> ▪ continuous PI control ▪ 2-step control (switching) 	Setting how the control value is to be output at the output.
Control value: 2-step control (switching)		
Switching hysteresis	0,5 K – 5,0 K [0,5 K]	Setting the hysteresis with which the 2-point control works.
Control value: continuous PI control		
Heating system	<ul style="list-style-type: none"> ▪ Warm water heating (4K / 150min) ▪ Underfloor heating (4K / 150min) ▪ Split Unit (4K / 60min) ▪ Adjustment via control parameter 	Setting of the used heating system.
Cooling system	<ul style="list-style-type: none"> ▪ Split unit (4K / 60min) ▪ Cooling ceiling (4K / 150 min) ▪ Adjustment via control parameter 	Setting of the used cooling system.
Proportional range	1 K – 20 K [4 K]	Only visible with the setting "Adjustment via control parameter". The proportional component can be freely set here.
Reset time	15 min – 240 min [150 min]	Only visible with the setting "Adjustment via control parameter". The integral range can be freely set here.
Additional stage	<ul style="list-style-type: none"> ▪ not active ▪ active 	Activation of an additional stage. Only available in the "Heating" operating mode.
The following settings are displayed when the additional level is "active":		
Direction of action with rising temperature	<ul style="list-style-type: none"> ▪ Object sends 1 when Heating ▪ Object sends 0 when Heating 	Setting the polarity for the object when heated.
Control value	<ul style="list-style-type: none"> ▪ 2-step control (switching) ▪ PI control switching (PWM) 	Setting the used controller type.
Distance	0,5 K – 5,0 K [2,0 K]	Defining the setpoint of the additional stage as the difference to the current setpoint.

Table 49: Basic settings – Controller type "integrated controller"

The **operating mode** determines whether the channel is used only for "Heating", only for "Cooling" or for "Heating and cooling". Thus, even if a channel has been configured for "Heating and Cooling" in the "General Settings", it can, for example, only be used for "Heating". In this case, the global switchover for Heating/Cooling determines whether the channel can become active or not.

The "**System**" parameter is only available if the operating mode is set to "Heating and Cooling". The displayed text is then fixed and cannot be changed. With the setting "Independent system -> not active", the system (2-pipe or 4-pipe) that was defined in the general settings is displayed. With the setting "Independent system -> active", the system "4-pipe/2-circuit (Heating and Cooling separately)" is always displayed. This cannot be changed.

If the "**Independent system**" parameter is activated, the channel is independent of the global Heating/Cooling switchover. Switching is then automatic, depending on temperature and dead zone (see [4.6.2.1.2 Dead zone](#)).

The parameter "**Control value**" defines how the output is controlled. This can be done either via the 2-step control (1 bit) or a continuous PI control (1 byte).

If "**2-step control**" is selected, the "**switching hysteresis**" is defined via an additional parameter. The setting of the switching hysteresis is used by the controller to calculate the switch-on and switch-off point. This is done considering the currently valid setpoint.

Example: A basic comfort value of 21°C and a hysteresis of 2K have been set in the controller in Heating mode. In Comfort mode, this results in a switch-on temperature of 20°C and a switch-off temperature of 22°C.

When setting, note that a large hysteresis leads to a large fluctuation of the actual room temperature. A small hysteresis, however, can cause a permanent switching-on/-off of the control value, since the switch-on and switch-off points are close to each other.

When selecting "**continuous PI control**", the **Heating/Cooling system** can still be defined: The individual control parameters are set via the setting of the Heating/Cooling system used, P-component and I-component. It is possible to use preset values that match certain Heating- or Cooling systems or to freely configure the P-controller and I-controller components. The preset values for the respective Heating- or Cooling systems (Warm water heating, Underfloor heating, Split unit, Cooling ceiling) are based on empirical values tested in practice and usually lead to good control results.

If a free "**Adjustment via control parameters**" is selected, the proportional range and reset time can be freely parameterised.

Important:

This setting requires sufficient knowledge in the field of control technology!

Proportional range

The proportional range stands for the P component of a control. The P component of a control leads to a proportional increase of the control value to the control difference.

A small proportional band leads to a fast control of the control difference. With a small proportional range, the controller reacts almost immediately and sets the control value almost to the maximum value (100%) even with small control differences. However, if the proportional range is selected too small, the danger of overshooting is very high.

A proportional range of 4K sets the control value to 100% at a control deviation (difference between setpoint and current temperature) of 4°C. This means that a control deviation of 4°C would occur at this setting. Thus, with this setting, a control deviation of 1°C would lead to a control value of 25%.

Reset time

The reset time represents the I component of a control. The I component of a control leads to an integral approximation of the actual value to the setpoint. A short reset time means that the controller has a strong I component.

A short reset time causes the control value to quickly approach the control value set according to the proportional range. A long reset time, on the other hand, causes a slow approach to this value.

When making the setting, it should be noted that a reset time that is set too short could cause overshooting. Basically, the more sluggish the system is, the longer the reset time.

4.6.1.1 Additional stage

The additional stage is only available in "Heating" mode.

This can be used in sluggish systems to shorten the heating phase. For example, with underfloor heating (as the basic stage), a radiator or an electric heater could be used as an additional stage to shorten the longer heating phase of the sluggish underfloor heating.

Via the "**Direction of action with rising temperature**", it can be set whether a "1" or a "0" is sent for the heating process. The 2-point control and the PWM control are available to the user for setting the controller type of the control value. The communication object of the additional stage is therefore in any case a 1-bit object and only switches the control value ON or OFF. The cycle time in the "PWM (switching PI control)" selection is internally set to 15 minutes.

The setpoint of the additional stage can be configured with the **distance** (in K). The set distance is subtracted from the setpoint of the basic level, which then results in the setpoint for the additional stage.

Example: The controller is in Comfort mode for which a basic comfort value of 21°C has been set. The distance of the additional stage has been set to 2.0K. This results in the following for the setpoint of the additional level: 21°C - 2.0K = 19°C

The table shows the communication object for the additional stage:

Number	Name	Length	Usage
16	Additional stage: Send control value Heating	1 Bit	Controlling the actuator for the additional level

Table 50: Communication object – Additional level

4.6.2 Controller

The following picture shows the setting options (here in the operating mode "Heating"):

Priority	<input checked="" type="radio"/> Frost(Heat) protection/Comfort/Night/Standby <input type="radio"/> Frost(Heat) protection/Night/Comfort/Standby
Setpoints for Standby/Night	<input type="radio"/> independent setpoints <input checked="" type="radio"/> dependent on "(Basic) Comfort setpoint"
(Basic) Comfort setpoint	21 °C
Standby reduction	2,0 K
Night reduction	3,0 K
Setpoint Frost protection setting	<input checked="" type="radio"/> global <input type="radio"/> individual
Maximum setpoint shift	5 K
Setpoint shift over 1Bit/1Byte object	not active
Status setpoint shift	<input checked="" type="radio"/> not active <input type="radio"/> active
Setpoint shift applies to	<input checked="" type="radio"/> Comfort <input type="radio"/> Comfort / Night / Standby
Action when shifting to night/standby	<input checked="" type="radio"/> no action <input type="radio"/> change to Comfort
Delete setpoint shift after change of mode	<input checked="" type="radio"/> not active <input type="radio"/> active
Delete setpoint shift after new (Basic) Comfort setpoint	<input checked="" type="radio"/> not active <input type="radio"/> active
Reset (Basic) Comfort setpoint to configured value after change of mode	<input checked="" type="radio"/> not active <input type="radio"/> active
Send setpoint change	<input checked="" type="radio"/> not active <input type="radio"/> active
Comfort extension with time	<input checked="" type="radio"/> not active <input type="radio"/> active
Operating mode after reset	Comfort with parameterized setpoint
HVAC Status object	<input type="radio"/> HVAC Status (non-standard DPT) <input checked="" type="radio"/> HVAC Mode (DPT 20.102)
Additional HVAC Status object	not active
Send HVAC Status object cyclically	not active
Alarms	<input checked="" type="radio"/> not active <input type="radio"/> active
Window contact	<input checked="" type="radio"/> not active <input type="radio"/> active

Figure 27: Settings – Controller

4.6.2.1 Setpoints, dead zone, operating modes & priorities

As a basis, it must be determined in advance how the setpoints are to be specified. The following selection is available for this purpose:

Setpoints for Standby/Night

independent setpoints
 dependent on "(Basic) Comfort setpoint"

Figure 28: Settings – Setpoints for Standby/Night

The two options are described in detail in the next two chapters.

4.6.2.1.1 Setpoints: Dependent on "(Basic) Comfort setpoint"

With the setting "**dependent on "(Basic) Comfort setpoint"**", the operating modes Standby and Night always refer relative to the basic Comfort setpoint. If this changes due to a setpoint specification, the values for Standby and Night also change. Therefore, the values for reduction and increase are given as a temperature difference in "K" (Kelvin). Frost/Heat protection does not change here and always remains at the configured value.

The following table shows the individual operating modes and their setting ranges:

ETS-Text	Dynamic range [Default value]	Comment
(Basic) Comfort setpoint	7 ... 35 °C [21 °C]	The Basic Comfort value is the reference point of the control.
Standby reduction/increase	0 K – 10,0 K [2,0 K]	Reduction (for "Heating") or increase (for "Cooling") of the temperature when the mode "Standby" is selected. Is indicated relative to the Basic Comfort value. "Standby" is activated when no other operating mode is active.
Night reduction/increase	0 K – 10,0 K [3,0 K]	Reduction (for "Heating") or increase (for "Cooling") of the temperature when the mode "Night" is selected. Is indicated relative to the Basic Comfort value.
Setting of setpoint "Frost protection"	<ul style="list-style-type: none"> ▪ global ▪ individual 	Setting whether the setpoint refers to the value in the menu "General Settings" or is assigned individually.
Setpoint Frost protection	3 ... 12 °C [7 °C]	Setting of an individual setpoint. Visible when "Heating" is active.
Setting of setpoint "Heat protection"	<ul style="list-style-type: none"> ▪ global ▪ individual 	Setting whether the setpoint refers to the value in the menu "General Settings" or is assigned individually.
Setpoint Heat protection	24 ... 40 °C [35 °C]	Setting of an individual setpoint. Visible when "Cooling" is active.
Dead zone between Heating and Cooling	1 K – 10,0 K [2,0 K]	Setting range for the dead zone (range in which the controller activates neither the heating nor the cooling process).

Table 51: Settings – Operating modes & setpoints (depending on setpoint Comfort)

Operating mode "Comfort" is the reference operating mode of the controller. The values in the operating modes "Night" and "Standby" are based on this. The "Comfort" operating mode should be activated when the room is in use. The basic comfort value is configured as the setpoint. If the controller type is set to "Heating & Cooling", the Basic Comfort value applies to the heating operation. In Cooling mode, the value of the dead zone between Heating and Cooling is added.

The communication object for this operating mode is shown in the following table:

Number	Name	Length	Usage
19	Switch Comfort operating mode	1 Bit	Activating the Comfort operating mode

Table 52: Communication object – Operating mode "Comfort"

Operating mode "Night" is intended to cause a significant temperature reduction/increase, e.g. at night or at the weekend. The value is freely configurable and refers to the Basic Comfort value. Thus, if a reduction of 5K has been configured and a Basic Comfort value of 21°C has been set, the setpoint for the 'Night' operating mode is 16°C. In Cooling mode, there is a corresponding increase in the value.

The communication object for this operating mode is shown in the following table:

Number	Name	Length	Usage
20	Switch Night operating mode	1 Bit	Activating the Night operating mode

Table 53: Communication object – Operating mode "Night"

Operating mode "Standby" is used when no one is using the room. It should cause a slight reduction/increase of the temperature. This value should be set significantly lower than the value for the "Night" operating mode to enable a faster reheating/cooling of the room. The value is freely configurable and refers to the Basic Comfort value. So, if a reduction of 2K has been set in the parameters and a Basic Comfort value of 21°C has been set, the setpoint for the 'Standby' operating mode is 19°C. In "Cooling" mode, there is a corresponding increase in the value.

The "Standby" operating mode is then activated as soon as all other operating modes are deactivated. Thus, this operating mode also has no communication object.

Operating mode "Frost-/Heat protection"

The "Frost protection" operating mode is activated as soon as the "Heating" function has been assigned to the controller. The "Heat protection" operating mode is activated as soon as the "Cooling" function has been assigned to the controller. If the "Heating & Cooling" function is assigned to the controller, a combined operating mode called "Frost/Heat Protection" is activated.

The "Frost/Heat Protection" operating mode causes heating or cooling to be switched on automatically if the temperature falls below or exceeds the configured temperature. The temperature is set as an absolute value here. If, for example, the temperature must not fall below a certain value during a longer absence, the "Frost protection" operating mode should be activated.

The communication object for this operating mode is shown in the following table:

Number	Name	Length	Usage
21	Switch Frost protection operating mode	1 Bit	Activating the Frost protection operating mode
21	Switch Heat protection operating mode	1 Bit	Activating the Heat protection operating mode
21	Switch Frost/Heat protection operating mode	1 Bit	Activating the Frost/Heat protection operating mode

Table 54: Communication objects – Operating mode "Frost/Heat protection"

4.6.2.1.2 Dead zone

If the control mode is set to "Heating and Cooling", the following parameter is displayed:

ETS-Text	Dynamic range [Default value]	Comment
Dead zone between Heating and Cooling	0 K – 10,0 K [0 K]	Setting range for the dead zone (range in which the controller activates neither the heating nor the cooling process)

Table 55: Setting – Dead zone

The settings for the dead zone are only possible if the controller type is set to "Heating and Cooling". As soon as this setting is made, the dead zone can be parameterised.

The dead zone is the area in which the controller does not activate either the heating or cooling process. Consequently, the controller does not send any value to the control value in the area of the dead zone and therefore the control value remains switched off. When setting the dead zone, please note that a low value leads to frequent switching between heating and cooling, whereas a high value leads to a large fluctuation of the actual room temperature.

If the controller is set to "Heating and Cooling", the basic comfort value always forms the setpoint for the heating process. **The setpoint for cooling is calculated by adding the base comfort value and the dead zone.** So, if the base comfort value is set to 21°C and the dead zone to 3K, the setpoint for the heating process is 21°C and the setpoint for the cooling process is 24°C.

The dependent setpoints for heating and cooling, i.e., those for the standby and night operating modes, can again be parameterised independently of each other in the controller mode "Heating and Cooling". The setpoints are then calculated as a function of the basic comfort value, the setpoint for the comfort operating mode, for the heating and cooling process.

The setpoints for heat and frost protection are independent of the settings for the dead zone and the other setpoints.

The following diagram shows again the relationship between dead zone and the setpoints for the individual operating modes:

The following settings were selected for this example:

Basic comfort value: 21°C. Dead zone between Heating and Cooling: 3K

Increase and reduction Standby: 2K. Increase and reduction Night: 4K

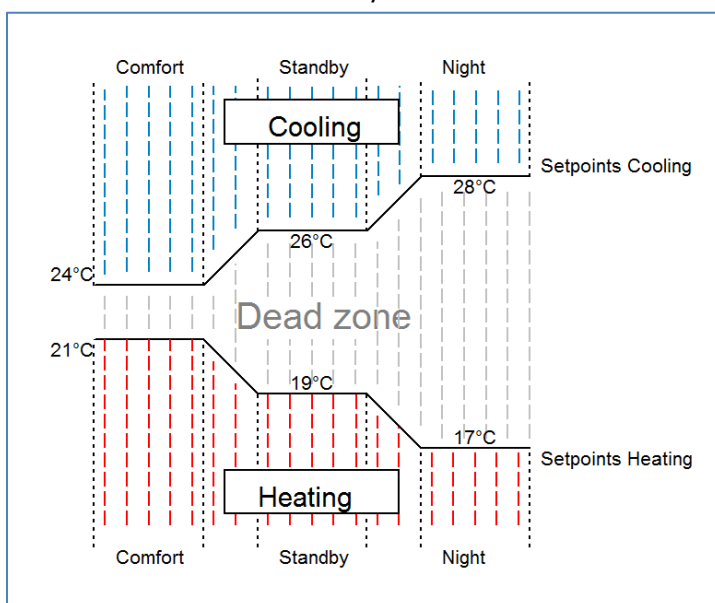

Figure 29: Example – Dead zone and corresponding setpoints

4.6.2.1.3 Independent setpoints

With the "Independent setpoints" setting it is possible to specify the values for Comfort, Night, Standby and Frost (when in "Heating" mode) or Heat protection (in "Cooling" mode) independently of each other as absolute values in "°C". This means that there is no longer a reference to the comfort setpoint. This also means that there is no longer a fixed dead zone.

The following table shows the available settings (Default values for "Heating" respectively "Cooling"):

ETS-Text	Dynamic range [Default value]	Comment
Setpoint Comfort (Basic)	7 ... 35 °C [21 °C] [23 °C]	Setpoint for Comfort operating mode
Setpoint Standby	7 ... 35 °C [19 °C] [24 °C]	Setpoint for Standby operating mode. Standby is activated when no other operating mode is active.
Setpoint Nacht	7 ... 35 °C [18 °C] [25 °C]	Setpoint for Night operating mode.
Setting of setpoint "Frost protection"	<ul style="list-style-type: none"> ▪ global ▪ individual 	Setting whether the setpoint from the "General setting" menu applies or should be set individually. Visible when "Heating" is active.
Setpoint Frost protection	3 ... 12 °C [7 °C]	Setpoint of the Frost protection mode. Visible with setting "individual".
Setting of setpoint "Heat protection"	<ul style="list-style-type: none"> ▪ global ▪ individual 	Setting whether the setpoint from the "General setting" menu applies or should be set individually. Visible when "Cooling" is active.
Setpoint Heat protection	24 ... 40 °C [35 °C]	Setpoint of the Heat protection mode. Visible with setting "individual".
Separate objects for setpoints Comfort/ Standby /Night/Frost protection/Heat protection	<ul style="list-style-type: none"> ▪ not active ▪ active, single objects ▪ active, combination object (DPT 275.100) 	Setting of how the setpoint value is to be specified. Individual objects are only possible in the modes "Heating" or "Cooling".

Table 56: Settings – Operating modes and Setpoints (independent setpoints)

Functional description:

The values for each operating mode are defined by the configuration in the ETS.

Now a new setpoint can be specified for each operating mode without affecting any other operating mode.

The setting can be done via **single objects** (only "Heating" or only "Cooling") for each operating mode or as **8-byte combination object** ("Heating", "Cooling", "Heating and Cooling").

In addition, there is a general object for the setpoint setting. The setpoint that is currently active is changed via the general communication object "" – Preset setpoint" (except for Frost/Heat protection!).

Sent values are always reported back in the same way. There is no longer a difference when switching between Heating and Cooling (no shift due to dead zone) or reduction/increase between the operating modes.

4.6.2.1.4 Priority of the operating modes

The following table shows the possible settings for this parameter:

ETS-Text	Dynamic range [Default value]	Comment
Priority	<ul style="list-style-type: none"> ▪ Frost(Heat) protection/Comfort/Night/Standby ▪ Frost(Heat) protection/Night/Comfort/Standby 	Setting the priorities of the operating modes

Table 57: Setting – Priority of the operating modes

The priority setting of the operating modes can be used to determine which operating mode is switched on with priority if several operating modes are selected. If, for example, Comfort and Night are switched on at the same time in the priority “Frost(Heat) protection/Comfort/Night/Standby”, the controller remains in Comfort mode until it is switched off. Then the controller automatically switches to Night mode.

4.6.2.2 Operating mode switchover (Mode selection)

There are 2 possibilities for operating mode switching: On the one hand, the operating mode can be controlled via the associated 1-bit communications objects and on the other hand, the operating mode can be controlled via a 1-byte object.

The selection of operating modes via 1 bit is done by direct control of the individual communication object. Considering the set priority, the operating mode controlled via its communication object is switched on or off. To switch the controller from an operation mode with higher priority to one with lower priority, the previous operation mode first must be deactivated with a logical 0. If all operation modes are switched off, the controller switches to Standby mode.

Example (set priority: Frost(Heat) protection/Comfort/Night/Standby):

Operating mode				Set operating mode
Comfort	Night	Frost/Heat protection		
1	0	0		Comfort
0	1	0		Night
0	0	1		Frost/Heat protection
0	0	0		Standby
1	0	1		Frost/Heat protection
1	1	0		Comfort

Table 58: Example – Mode selection via 1 Bit

The mode selection via 1 byte is done via only one object, the DPT HVAC Mode 20.102 according to the KNX specification. For mode selection, a hex value is sent to the "mode selection" object. The object evaluates the received hex value and thus switches the associated operating mode on and the previously active operating mode off. If all operating modes are switched off (hex value = 0), the Standby operating mode is switched on.

The Hex-values for the individual operating modes can be taken from the following table:

Mode selection (HVAC Mode)	Hex-value
Comfort	0x01
Standby	0x02
Night	0x03
Frost/Heat protection	0x04

Table 59: Hex values of HVAC Modes

The following example illustrates how the controller processes received hex values and thus switches operating modes on or off. The table is based on each other from top to bottom.

Example (set priority: Frost(Heat) protection/Comfort/Night/Standby):

Received Hex value	Processing	Set operating mode
0x01	Comfort = 1	Comfort
0x03	Comfort = 0 Night = 1	Night
0x02	Night = 0 Standby = 1	Standby
0x04	Standby = 0 Frost/Heat protection = 1	Frost/Heat protection

Table 60: Example – Mode selection via 1 Byte

The controller always reacts to the last value sent. If, for example, an operating mode was last selected via a 1 Bit command, the controller reacts to the switchover via 1 Bit. If a hex value was last sent via the 1 Byte object, the controller reacts to the switchover via 1 Byte.

Important: There is no priority between switching over 1 Bit and 1 Byte!

The communication objects for the operating mode switchover are as follows:

Number	Name	Length	Usage
17	Mode selection	1 Byte	Selection of operating modes
19	Switch Comfort operating mode	1 Bit	Activating the Comfort mode
20	Switch Night operating mode	1 Bit	Activating the Night mode
21	Switch Frost/Heat protection operating mode	1 Bit	Activating the Frost/Heat protection mode

Table 61: Communication objects – Mode selection

4.6.2.3 Setpoint shift

The following table shows the available settings:

ETS-Text	Dynamic range [Default value]	Comment
Maximum setpoint shift	0 ... 10 K [3 K]	Setting the maximum setpoint shift.
Setpoint shift over 1Bit/1Byte object	<ul style="list-style-type: none"> ▪ not active ▪ 1 Bit ▪ 1 Byte 	Setting whether setpoint shift is to be activated via 1 bit or 1 byte.
Step width	0,1 K – 1 K [0,5 K]	Setting of the step width for the setpoint shift over 1 Bit/1 Byte. Only visible if setpoint shift over 1 Bit/1 Byte is active.
Status setpoint shift	<ul style="list-style-type: none"> ▪ not active ▪ active 	Activation of an object to send the current status of the setpoint shift.
Setpoint shift applies to	<ul style="list-style-type: none"> ▪ Comfort ▪ Comfort/Night/Standby 	Validity range of the setpoint shift.
Action when shifting to Night/Standby	<ul style="list-style-type: none"> ▪ no action ▪ change to Comfort 	Setting whether to switch back to Comfort after a setpoint shift during Night or Standby mode. Only visible if setpoint shift is only active for Comfort.
Delete setpoint shift after change of mode	<ul style="list-style-type: none"> ▪ not active ▪ active 	Setting whether the current setpoint shift is to be deleted after a change of operating mode or not.
Delete setpoint shift after new absolute setpoint	<ul style="list-style-type: none"> ▪ not active ▪ active 	Setting whether the current setpoint shift should be deleted or not after a new absolute setpoint has been specified. Only visible when "independent setpoints" is selected.
Delete setpoint shift after new (Basic) Comfort setpoint	<ul style="list-style-type: none"> ▪ not active ▪ active 	Setting whether the current setpoint shift should be deleted or not after a new basic setpoint has been specified. Only visible if "dependent on comfort setpoint (basic)" is selected.
Reset (Basic) Comfort setpoint to configured value after operation mode change	<ul style="list-style-type: none"> ▪ not active ▪ active 	Setting whether the basic setpoint should be reset to the configured basic setpoint after an operating mode change. Only visible if "dependent on comfort setpoint (basic)" is selected.
Send setpoint change	<ul style="list-style-type: none"> ▪ not active ▪ active 	Setting whether a change of the setpoint value should be sent
Send current setpoint cyclically	not active 5 min – 4 h	Setting whether and at what intervals the object is to be sent cyclically

Table 62: Settings – Setpoint shift

Setpoint shift

The basic comfort setpoint is permanently configured via the ETS. This setpoint can be changed in two ways. On the one hand, a new absolute setpoint can be specified for the controller; this is done via the communication object "(Basic) Comfort setpoint" as a 2-byte absolute value, and on the other hand, the preset setpoint can be raised or lowered manually. This can be done via the communication objects "manual setpoint shift", either via 1 bit, 1 byte or 2 bytes.

With the setpoint shift, the currently set setpoint is shifted as a temperature difference. The "manual setpoint shift" object is used for this. With the 1 byte/2 byte object, a positive Kelvin value is sent to the controller to increase the temperature or a negative Kelvin value to decrease it. With the manual setpoint shift via the 1 bit object, only on/off commands are sent and the controller raises the setpoint by the set increment when it receives a "1" and lowers the setpoint by the set increment when it receives a "0".

The setpoint shift via 2 byte is automatically active for the controller, the corresponding communication object 9 is permanently displayed. The shift via 1 bit/1 byte can be activated via parameters.

When the setpoint is shifted, the parameterised basic comfort value is not changed as a reference value for the other operating modes!

The maximum manual shift of the setpoint can be limited via the "**Maximum setpoint shift**" setting. If, for example, the controller is set to a basic comfort value of 21°C and a maximum setpoint shift of 3K, the basic comfort value can only be manually shifted within the limits of 18°C to 24°C.

Activating the "**Status setpoint shift**" creates a further object. This can be used to send the current status of the setpoint shift. This is important for some visualisations for their correct function.

The "**Setpoint shift applies to**" setting can be used to set whether the shift only applies to the comfort mode or whether the setting should also be adopted for the Night and Standby operating modes. The Frost/Heat protection operating modes are in any case independent of the setpoint shift. The setting "**Delete setpoint shift after change of operating mode**" can be used to set whether the new setpoint should be retained after a change of operating mode or whether the controller should return to the value configured in the ETS software after a change of operating mode.

Delete setpoint shift after new absolute setpoint means that the setpoint shift is always deleted as soon as a new setpoint is assigned via object.

Delete setpoint shift after new basic setpoint value has the effect that after a new basic setpoint value has been specified as an absolute value, the setpoint shift that has taken place is deleted and is started with the new setpoint value.

Reset basic setpoint to configuration after change of operating mode causes the setpoint to be reset to the configured basic value after each change of operating mode.

If the parameter "**Send setpoint changes**" is activated, the new, now valid setpoint is sent on the bus via the communication object "Current setpoint" with each change.

When a new absolute comfort setpoint is read in, a new basic comfort value is assigned to the controller. There is a significant difference in the Smart room temperature controller between the settings "dependent on comfort setpoint (basic)" and "independent setpoints".

"Depending on "(Basic) Comfort setpoint"

This new basic comfort value (object "1") also automatically causes an adjustment of the dependent setpoints in the other operating modes, as these are relative to the basic comfort value. All settings for setpoint shifting do not apply here, as a completely new base value is assigned to the controller.

The specification of a setpoint via the communication object "0 - Setpoint setting" offers a special feature. Here the new value is written to the basic comfort setpoint, a valid setpoint shift is deleted and the controller automatically jumps to comfort, regardless of which mode the controller was in before. This procedure is required for visualisations that make changes via absolute setpoints. This ensures that the new setpoint sent is also reported back.

"Independent setpoints"

Here, an individual absolute value can be specified for each operating mode. If, for example, the setpoint is changed in Comfort mode (object "1"), the other setpoints remain unaffected.

A special feature is the common object "0 - setpoint setting". This always changes the setpoint in the currently valid mode. If, for example, the controller is currently in Standby mode and the value "20°C" is sent via object "0", the Standby setpoint is changed to "20°C" at this moment.

The following table shows the communication objects relevant for the setpoint change:

Number	Name	Length	Usage
2	Preset setpoint	2 Byte	Presetting of a new absolute setpoint
3	Preset Comfort setpoint	2 Byte	Presetting of a new absolute setpoint
3	Combi object: Preset setpoints	8 Byte	Preset setpoints for 4 HVAC modes via common combi object
3	Combi object (Heating): Preset setpoints	8 Byte	Preset setpoints for 4 HVAC modes via common combi object
3	Preset (Basic) Comfort setpoint	2 Byte	Presetting of a new absolute setpoint
3	Preset Comfort setpoint	2 Byte	Presetting of a new absolute setpoint
4	Preset Standby setpoint	2 Byte	Presetting of a new absolute setpoint
5	Preset Night setpoint	2 Byte	Presetting of a new absolute setpoint
6	Preset Frost protection setpoint	2 Byte	Presetting of a new absolute setpoint
6	Preset Heat protection setpoint	2 Byte	Presetting of a new absolute setpoint
7	Combi object (Cooling): Preset setpoints	8 Byte	Preset setpoints for 4 HVAC modes via common combi object
8	Send current setpoint	2 Byte	Sends out the currently set setpoint
9	Manual setpoint shift (2 byte)	2 Byte	Shift of the setpoint relative to the preset comfort setpoint. Object is permanently displayed
10	Manual setpoint shift (1=+ / 0=-)	1 Bit	Increase/decrease the setpoint relative to the preset comfort setpoints by the set step size
10	Manual setpoint shift (1 byte)	1 Byte	Increase/decrease the setpoint relative to the preset comfort setpoints by the set step size
11	Send status of setpoint shift	2 Byte	Sending the current status of the setpoint shift

Table 63: Communication objects – Setpoint changes

4.6.2.4 Comfort extension with time

The comfort extension causes a temporary switching to comfort mode. The following parameters are available for this:

Figure 30: Settings – Comfort extension with time

The following table shows the setting options for this parameter:

ETS-Text	Dynamic range [Default value]	Comment
Comfort extension with time	<ul style="list-style-type: none"> ▪ not active ▪ active 	Activation of the Comfort extension via time-dependent object.
Comfort extension time	30 min, 1 h, 1,5 h, 2 h, 2,5 h, 3 h, 3,5 h, 4 h	Adjustable time for Comfort Extension.

Table 64: Settings – Comfort extension with time

If the comfort extension is activated, the following communication object appears:

Number	Name	Length	Usage
18	Comfort operating mode – Comfort extension	1 Bit	Temporary switching to Comfort mode via object for the duration of a predefined time

Table 65: Communication object – Comfort extension with time

The comfort extension can be used, for example, to extend the Comfort mode for visits, parties, etc. If, for example, a timer switches the channel to Night mode at a certain time, it can be switched back to Comfort mode for a certain time by means of the Comfort extension. When a 1 is sent to the Comfort extension object the channel switches from Night mode back to Comfort mode for the set "Comfort extension time". After the "Comfort extension time" has elapsed, the channel automatically switches back to Night mode. If the Comfort extension is to be ended before the time has expired, this can be achieved by sending a 0 to the object.

If a 1 is sent to the object again during the Comfort extension, the set time is restarted.

If the mode is changed during the extension, the time is stopped.

Important:

The comfort extension only works for switching from "Night" mode to "Comfort" mode and back!

4.6.2.5 Operating mode after reset

The following table shows all available settings:

ETS-Text	Dynamic range [Default value]	Comment
Operating mode after reset	<ul style="list-style-type: none"> ▪ Comfort with parameterized setpoint ▪ Standby with parameterized setpoint ▪ hold old state and setpoint 	Setting which operating mode or behaviour is to be activated after a bus power return.
Operating mode after reprogramming	<ul style="list-style-type: none"> ▪ Comfort ▪ Standby 	Only available with setting "hold old state and setpoint". Determination of the operating mode after reprogramming the unit.

Table 66: Settings – Operating mode after reset

- **Comfort with parameterized setpoint**
After a bus voltage return, the comfort is activated with the setpoint that was specified by the ETS.
- **Standby with parameterized setpoint**
After a bus voltage return, the Standby mode is activated with the setpoint that was specified by the ETS (Comfort setpoint minus Standby reduction).
- **Hold old state and setpoint**
The temperature controller recalls the setpoint and mode that was set before the bus was switched off.
 - **Operating mode after reprogramming**
This setting can be used to define the operating mode after a reset.

4.6.2.6 HVAC Status objects

There are several options for visualising the operating modes.
The following settings are available for the HVAC status objects:

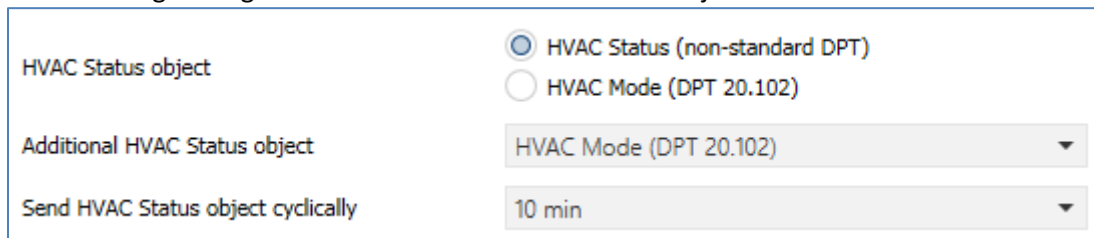

The screenshot shows a settings window for HVAC status objects. It contains three main sections:

- HVAC Status object:** Two radio buttons are present. The first, labeled 'HVAC Status (non-standard DPT)', is selected with a blue dot. The second, labeled 'HVAC Mode (DPT 20.102)', is unselected.
- Additional HVAC Status object:** A dropdown menu is set to 'HVAC Mode (DPT 20.102)'.
- Send HVAC Status object cyclically:** A dropdown menu is set to '10 min'.

Figure 31: Settings – HVAC status objects

The following table shows all available settings:

ETS-Text	Dynamic range [Default value]	Comment
HVAC-Status object	<ul style="list-style-type: none"> ▪ HVAC Status (non-standard DPT) ▪ HVAC Mode (DPT 20.102) 	Selection of whether the status is to be output as HVAC Status or HVAC Mode.
Additional HVAC-Status object	<ul style="list-style-type: none"> ▪ not active ▪ HVAC Status (non-standard DPT) ▪ HVAC Mode (DPT 20.102) ▪ RHCC Status (DPT 22.101) ▪ RTC combined status (DPT 22.103) ▪ RTSM combined status (DPT 22.107) 	Setting an additional HVAC status object.
Send HVAC Status object cyclically	<p style="text-align: center;">not active 5 min – 4 h</p>	Setting whether and at what intervals the object is to be sent cyclically.

Table 67: Settings – HVAC status objects

The **HVAC Status (non-standard DPT)** according to the KNX specification sends the corresponding hex value for the currently set operating mode. If several statements apply, the hex values are added, and the status symbol then outputs the added hex value. The hex values can then be read out by a visualisation.

The following table shows the hex values associated with the individual messages:

Bit	DPT HVAC Status		Hex-value
0	Comfort	1=Comfort	0x01
1	Standby	1=Standby	0x02
2	Night	1=Nacht	0x04
3	Frost/Heat protection	1= Frost/Heat protection	0x08
4			
5	Heating/Cooling	0=Cooling/1=Heating	0x20
6			
7	Frost alarm	1=Frost alarm	0x80

Table 68: Assignment – DPT HVAC Status

The object is used exclusively for status/diagnostic purposes. Furthermore, it is well suited for visualisation purposes. To visualise the object, it is easiest to evaluate the object bit by bit.

The object outputs the following values, for example:

0x21 = Controller in Heating mode with Comfort mode activated

0x01 = Controller in Cooling mode with Comfort mode activated

0x24 = Controller in Heating mode with Night mode activated

The **RHCC Status (DPT 22.101)** is an additional 2byte status object. It contains additional status messages. Here again, as with the HVAC object, the hex values are added for several messages and the added value is output.

The following table shows the hex values associated with the individual messages:

Bit	DPT RHCC Status		Hex-value
0	Error measuring sensor	1=Error	0x01
8	Heating/Cooling	0=Cooling/1=Heating	0x80
13	Frost alarm	1=Frost alarm	0x2000
14	Heat alarm	1=Heat alarm	0x4000

Table 69: Assignment – DPT RHCC Status

With the RHCC Status, various error messages or basic settings can therefore be displayed or requested.

RTC combined status (DPT 22.103)

This is a combined status according to DPT 22.103.

The assignment is as follows:

Bit	Beschreibung / Description	Codierung / Encoding
0	Allgemeiner Fehler General failure information	0=kein Fehler/no failure 1=Fehler/failure
1	Aktiver Mode Active mode	0=Kühlen/Cool mode 1=Heizen/Heat mode
2	Taupunkt Status Dew point status	0=kein Alarm/no alarm 1=Alarm (RTC gesperrt)/alarm (RTC locked)
3	Frost Alarm Frost Alarm	0=kein Alarm/no alarm 1=Alarm/alarm
4	Hitze Alarm Overheat-Alarm	0=kein Alarm/no alarm 1=Alarm/alarm
6	Zusätzliche Heiz-/Kühlstufe (2. Stufe) Additional heating/cooling stage (2. Stage)	0=Inaktiv/inactive 1=Aktiv/active
7	Heizmodus aktiviert Heating mode enabled	0=Falsch/false 1=Wahr/true
8	Kühlmodus aktiviert Cooling mode enabled	0=Falsch/false 1=Wahr/true

Table 70: Assignment – RTC combined status DPT 22.103

RTSM combined status (DPT 22.107)

This is a combined status according to DPT 22.107. The assignment is as follows:

Bit	Beschreibung / Description	Codierung / Encoding
0	Effektiver Wert des Fensterstatus Effective value of the window status	0 = alle Fenster geschlossen/ all windows closed 1 = mindestens ein Fenster geöffnet/ at least one window opened
1	Effektiver Wert des Präsenzstatus Effective value of the presence status	0 = keine Meldung einer Präsenz/ no occupancy from presence detectors 1 = mindestens ein Melder belegt/ occupancy at least from one presence detector
3	Status der Komfortverlängerung Status of comfort prolongation User	0 = Komfortverlängerung nicht aktiv/ comfort prolongation User not active 1 = Komfortverlängerung aktiv/ comfort prolongation User not active

Table 71: Assignment – RTSM combined status DPT 22.107

4.6.2.7 Reference control via outside temperature

Important: This parameter is only available in Cooling mode (“Cooling” or “Heating and Cooling”)!

The following settings are available:

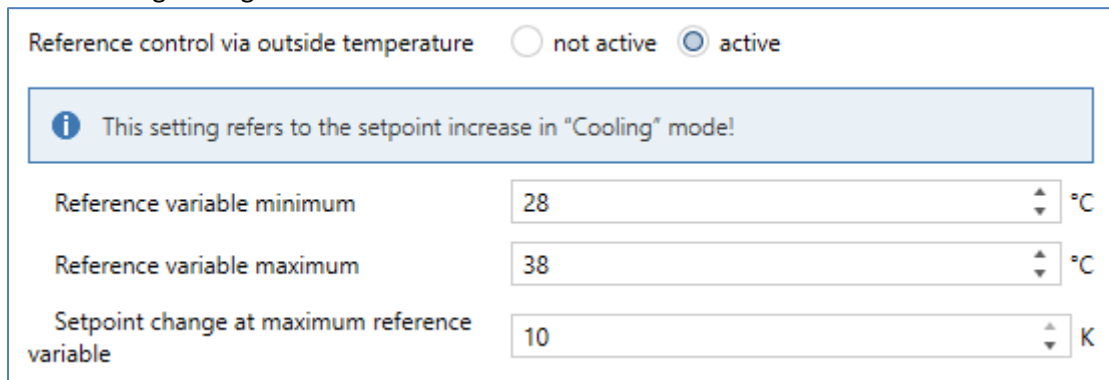

Figure 32: Settings – Reference control via outside temperature

The following table shows the setting options for this parameter:

ETS-Text	Dynamic range [Default value]	Comment
Reference control via outside temperature	<ul style="list-style-type: none"> ▪ not active ▪ active 	Activation of the parameter. Only available in “Cooling” mode!
Reference variable minimum	10 ... 60 °C [28°C]	Lower response value for reference control.
Reference variable maximum	10 ... 60 °C [38°C]	Upper response value for reference control.
Setpoint change at maximum reference variable	1 ... 10 K [10 K]	Setpoint shift when maximum reference variable is reached.

Table 72: Settings – Reference control via outside temperature

The "Reference control via outside temperature" parameter makes it possible to linearly track the setpoint as a function of any reference variable, which is recorded via an external sensor. With appropriate configuration, a continuous increase or decrease of the setpoint can be achieved. Three settings have to be made to determine the extent to which the command has an effect on the setpoint: **Minimum reference variable** (w_{min}), **maximum reference variable** (w_{max}), and the **setpoint change at maximum reference variable** (ΔX).

The settings for the reference variable maximum (w_{max}) and reference variable minimum (w_{min}) describe the temperature range in which the reference variable begins and ends to influence the setpoint. The setpoint change at maximum reference variable (ΔX_{max}) describes the ratio of how strongly an increase in the reference temperature affects the setpoint. The actual setpoint change then results from the following relationship:

$$\Delta X = \Delta X_{max} * [(w - w_{min}) / (w_{max} - w_{min})]$$

If the reference control is to be increased, a positive value has to be set for the "setpoint change at maximum reference variable". If, on the other hand, a setpoint reduction is desired, the "setpoint change at maximum command value" has to be set to a negative value.

The setpoint change ΔX is then added to the basic comfort value.

A value above or below the reference value has no effect on the setpoint change. As soon as the value is within the reference variable (i.e., between w_{max} & w_{min}), the setpoint is lowered or raised. The following graphics are intended to illustrate the influence of the reference variable on the setpoint:

(Xsoll=new setpoint; Xbasis=base setpoint)

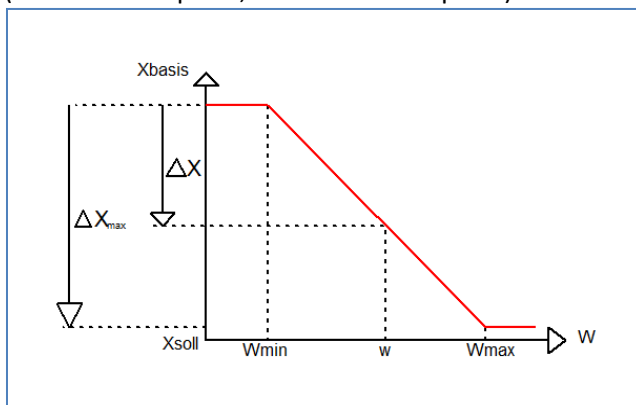

Figure 33: Example – Reference control/decrease

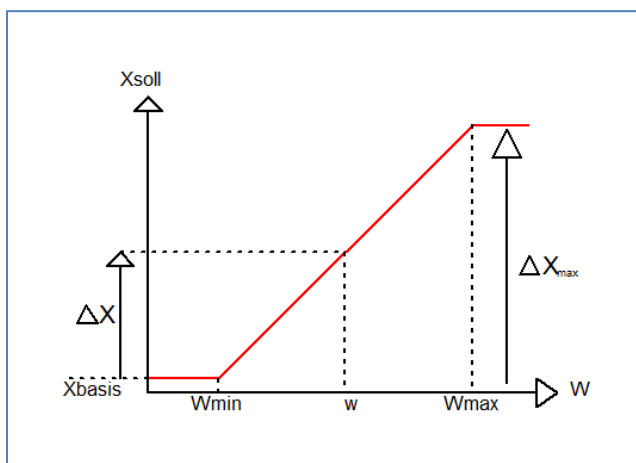

Figure 34: Example – Reference control/increase

With the communication object of the reference value, the current temperature of the external sensor can be read out. The communication object does not have to be linked with the communication object of the setpoints to activate the command but is only used to request the control temperature.

Important: With the MDT Heating Actuator, the external temperature is sent to a central object. This temperature is then the command value, valid for all channels.

The following table shows the corresponding object:

Number	Name	Length	Usage
*	Lead value (Outside temperature) – Receive measured value	1 Byte	Receiving an external measured value as a reference variable

Table 73: Communication object – Reference control via outside temperature

* Central objects are at the end of the list. The object number is therefore different, depending on the number of channels. For the AKH-0400.03 it is no. 174, for the AKH-0600.03 no. 254 and for the AKH-0800.03 no. 334.

Example of use:

For the temperature control of a room, the setpoint (22°C) should be raised so that in an outdoor temperature range of 28°C to 38°C the temperature difference between outdoor and indoor temperature does not exceed 6K.

Settings to be made:

- Basic comfort value: 22°C
- Reference control: active
- Minimum reference variable: 28°C
- Maximum reference variable: 38°C
- Setpoint change at maximum reference variable: 10°C

If the outdoor temperature were to rise to 32°C, the setpoint would be increased by the following value: $\Delta X = 10^\circ\text{C} * [(32^\circ\text{C}-28^\circ\text{C})/(38^\circ\text{C}-28^\circ\text{C})] = 4^\circ\text{C}$.

This would result in a new setpoint of 22°C+4°C=26°C.

If the outdoor temperature reaches the set maximum value of 38°C, the setpoint would be 32°C and would not increase any further if the temperature continues to rise.

4.6.2.8 Alarms

By means of the alarm function, the falling below or exceeding of a set temperature can be indicated via its associated communication objects:

Figure 35: Settings – Alarms

The setting options for this parameter are shown in the table below:

ETS-Text	Dynamic range [Default value]	Comment
Alarms	<ul style="list-style-type: none"> ▪ not active ▪ active 	Activation of the alarms.
Frost alarm if value less	3 ... 10°C [7°C]	Setting the temperature below which the Frost alarm is triggered. Only visible when alarms are “active”.
Heat alarm if value greater	25 ... 40 °C [35°C]	Setting the temperature above which the Heat alarm is triggered. Only visible when alarms are “active”.

Table 74: Settings – Alarms

The alarm function reports the falling below or exceeding of an adjustable temperature via the associated object. Falling below the lower detection value is reported via the Frost alarm object. Exceeding the upper detection value is reported via the heat alarm object. The two signalling objects of size 1 bit can be used for visualisation or for initiating countermeasures. If the lower detection value is exceeded again or the upper detection value is fallen short of again, a "0" is sent in each case and thus the alarm is cancelled.

The following table shows the two objects:

Number	Name	Length	Usage
24	Send Frost alarm	1 Bit	Reports falling below the lower reporting value
25	Send Heat alarm	1 Bit	Reports the exceeding of the upper reporting value

Table 75: Communication objects – Alarms

4.6.2.9 Window contact

The following settings are available for this parameter:

Window contact	<input type="radio"/> not active <input checked="" type="radio"/> active
State of window	<input checked="" type="radio"/> 0=closed / 1=open (standard DPT) <input type="radio"/> 1=closed / 0=open
Delay time	5 s
Action when opening the window	force Frost/Heat protection
Action when closing the window	<input checked="" type="radio"/> HVAC Modus before locking <input type="radio"/> HVAC Modus catch up
Release time	12 h

Figure 36: Settings – Window contact

The setting options for this parameter are shown in the table below:

ETS-Text	Dynamic range [Default value]	Comment
Window contact	<ul style="list-style-type: none"> ▪ not active ▪ active 	Setting whether window contact is monitored or not.
State of window	<ul style="list-style-type: none"> ▪ 0=closed / 1=open (standard DPT) ▪ 1=closed / 0=open 	Setting the polarity with which value the window is open/closed.
Delay time	0 ... 240 s [5 s]	Setting of a time by which the switching is delayed after opening/closing the window.
Action when opening the window	force Frost/Heat protection	Fixed text. Not changeable.
Action when closing the window	<ul style="list-style-type: none"> ▪ HVAC Modus before locking ▪ HVAC Modus catch up 	Definition of whether, after closing the window, it is switched to the mode before the lock or to a mode that was changed during the lock.
Release time	not active (not recommended) 1 h – 24 h [12 h]	Setting after which time the unit automatically switches back to the previous mode.

Table 76: Settings – Window contact

With this function, the control in a room can be forced into Frost or Heat protection after a window has been opened. Normal Heating/Cooling operation is interrupted for this time. In this way, it can be avoided, for example, that unnecessary energy is consumed for heating after opening a window in winter. After closing the window, it is then possible to switch back to normal operation.

The "**Delay time**" has the effect that the action to be carried out after opening/closing the window only takes place after a configurable time. This means that a short opening of the window can be carried out without influencing the control.

With "**Action when closing the window**" it can be set whether after closing, the window returns to the mode before the lock or to a mode that, for example, was sent during the lock as from a timer or a visualisation.

The "**Release time**" defines the time after which the controller automatically returns to the previous operating mode after the window has been opened. This is useful if, for example, you forget to close the window again. In this case, the room would be prevented from cooling down in winter or overheating in summer.

The following table shows the associated communication object:

Number	Name	Length	Usage
29	Window contact input – 0=closed / 1=open / 1=closed / 0=open	1 Bit	Receive the current window status. Displayed polarity depending on the setting in parameter.

Table 77: Communication object – Window contact

4.6.3 Output

The following settings are available in the "Output" menu of the channel (Here for operating mode "Heating"):

Valve type	<input checked="" type="radio"/> normally closed <input type="radio"/> normally opened
PWM cycle time	10 min
Minimum limitation of control value	0%
Maximum limitation of control value	100%
Limitation via object	not active
Control value when falling below the minimum limitation	<input checked="" type="radio"/> 0% = 0%, otherwise use minimum set value <input type="radio"/> 0% = minimum set value
Send control value cyclically	5 min
Object valve status	<input checked="" type="radio"/> valve status (1=open, 0=closed) <input type="radio"/> 1, if control value > 0%
Consider channel in Heating/Cooling requirement and max. control value	<input type="radio"/> not active <input checked="" type="radio"/> active
Forced position	<input type="radio"/> not active <input checked="" type="radio"/> active
Control value for forced position	50%
Additional sensor for flow temperature	<input checked="" type="radio"/> not active <input type="radio"/> active
Emergency mode	<input type="radio"/> not active <input checked="" type="radio"/> active
Emergency mode on failure of temperature value after...	30 Minutes
Control value for emergency mode	50%
Lock object for control value Heating	not active
Send diagnosis text	not active

Figure 37: Settings – Channel: Output (integrated controller)

4.6.3.1 General settings

At the beginning, some basic settings are made:

ETS-Text	Dynamic range [Default value]	Comment
Valve type	<ul style="list-style-type: none"> ▪ normally closed ▪ normally opened 	Setting of the type of valve.
Send control value cyclically	not active 1 min – 60 min [5 min]	Setting of a repetition time for sending a telegram. Available for "Heating" or "Cooling".
Send control value for Heating and Cooling cyclically	not active 1 min – 60 min [5 min]	Setting of a repetition time for sending a telegram. Available for "Heating and Cooling".
Consider channel in Heating/Cooling requirement and maximum control value	<ul style="list-style-type: none"> ▪ not active ▪ active 	Configuration of whether the channel is included in the calculation of the maximum control value and the Heating/Cooling requirement.

Table 78: Settings – Channel: General

The "**Valve type**" setting is used to configure the output so that it passes on the correct voltage states to the control valve for the respective switching states of the output. This is only an adjustment to normally closed/normally opened contacts. The output signal is inverted when the setting is "normally opened".

With the parameter "**Send control value cyclically**", a time interval can be defined when activated, in which the current control value is sent on the bus.

The following communication objects are available for this purpose:

Number	Name	Length	Usage
12	Control value: Send status	1 Bit	Sending the current control value. Only visible when "2 pipe system" and "Heating and Cooling"
12	Control value Heating: Send status	1 Bit	Sending the current control value
13	Control value Cooling: Send status	1 Bit	Sending the current control value

Table 79: Communication objects – Send valve state

Furthermore, you can set whether the channel is considered in the menu "general settings" for the **Heating/Cooling requirement and the maximum control value**. If this setting is activated, the actuator takes this channel into account when calculating the maximum control value and the Heating/Cooling requirement.

4.6.3.2 PWM cycle time

The setting "**PWM cycle time**" is used by the PWM control to calculate the switch-on and switch-off pulse of the control value. This calculation is based on the incoming control value. A PWM cycle comprises the total time that elapses from the switch-on point to the next switch-on point.

Example:

If a control value of 75% is calculated with a set cycle time of 10 minutes, the control value is switched on for 7.5 minutes and switched off for 2.5 minutes.

The setting options for the PWM cycle are shown in the following table:

ETS-Text	Dynamic range [Default value]	Comment
PWM cycle time	10 s – 30 min [10 min]	Setting the time for the duration of a PWM cycle.

Table 80: Settings – PWM cycle time

Basically, two different setting options have proven themselves. On the one hand, the setting where the valves can be completely opened and closed again within a complete cycle and, on the other hand, the setting where the cycle time is significantly shorter than the adjustment time of the valves and thus an average value is achieved.

The two setting options and their possible applications will be explained in more detail in the following sections. If several valves are to be controlled simultaneously, it is recommended to set according to the most inert system.

Option 1: Cycle time is larger than the adjustment time of the valves

This setting causes the valve to be completely opened and closed again within one cycle. During one cycle, the valve thus runs through the complete valve stroke.

The adjustment cycle time of a valve consists of a dead time (time that elapses between the activation of the valve and the opening process of the valve) and the actual adjustment time of the valve. The time in which the valve is actually open is therefore significantly shorter than the activation within a PWM cycle.

The principle of this option is shown at the diagram below:

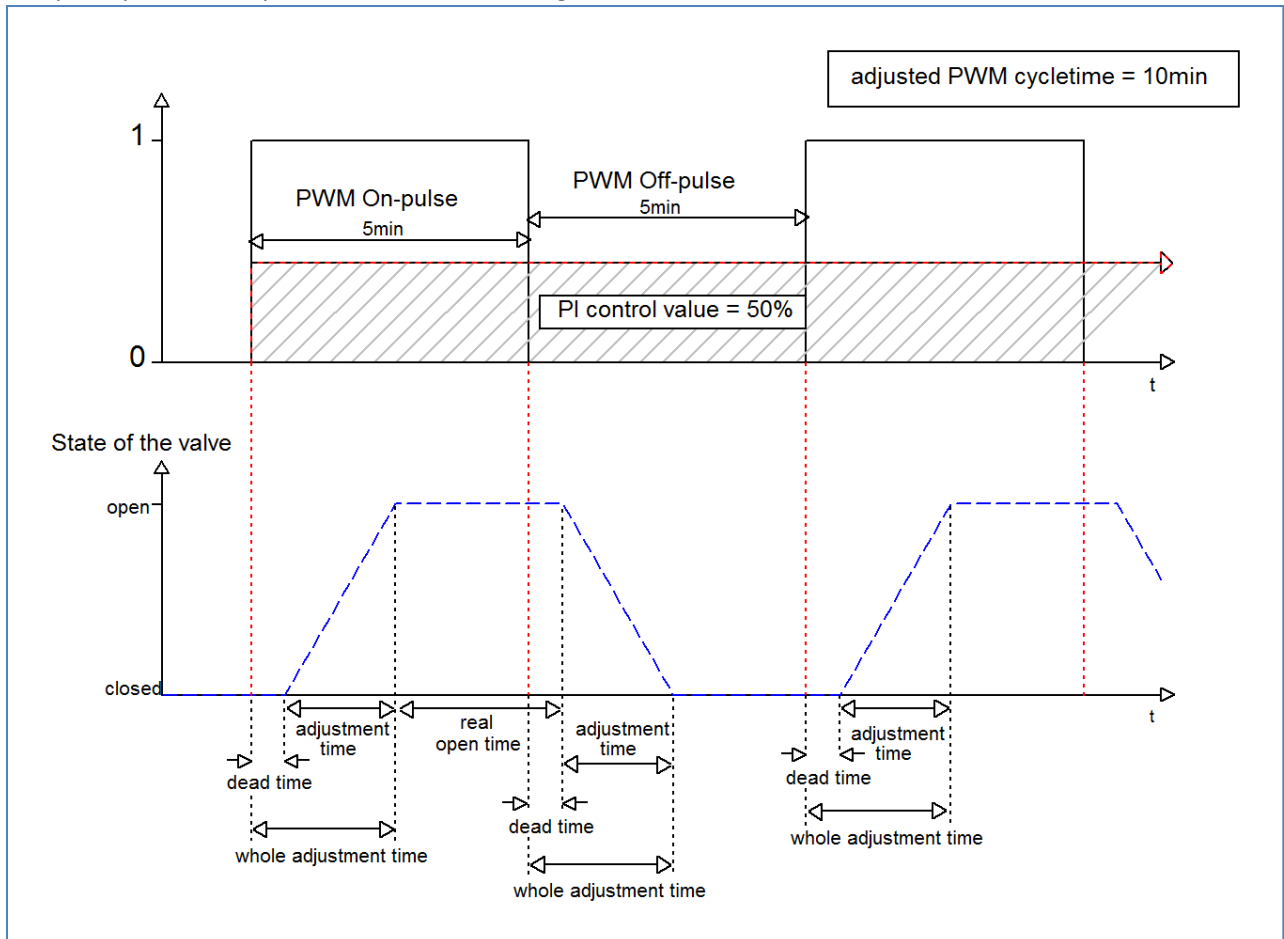

Figure 38: Diagram – PWM cycle time (1)

The total adjustment cycle time here is approximately 2.5-3 min, as is typically the case with valve drives for underfloor heating systems. By this adjustment cycle time, the valve is open for a shorter time than the PWM switch-on pulse is long, or closed for a shorter time than the PWM switch-off pulse is long. Although this adjustment cycle time shortens both the actual opening time and the actual closing time, this method regulates the room temperature relatively accurately.

However, the complete opening/closing of the valves can also lead to greater fluctuations in the temperature in the immediate vicinity of the heat source. Furthermore, due to the relatively frequent opening and closing of the valves, they are also subjected to greater stress.

This setting has proven particularly useful for slower systems, such as underfloor heating systems.

Option 2: Cycle time is shorter than the adjustment time of the valves

This setting has the effect that the valve cannot open completely within the PWM switch-on pulse or switch-off pulse, but always goes through small movements. In the long term, this setting results in an average value for the opening of the valve.

The principle of this option is shown at the diagram below:

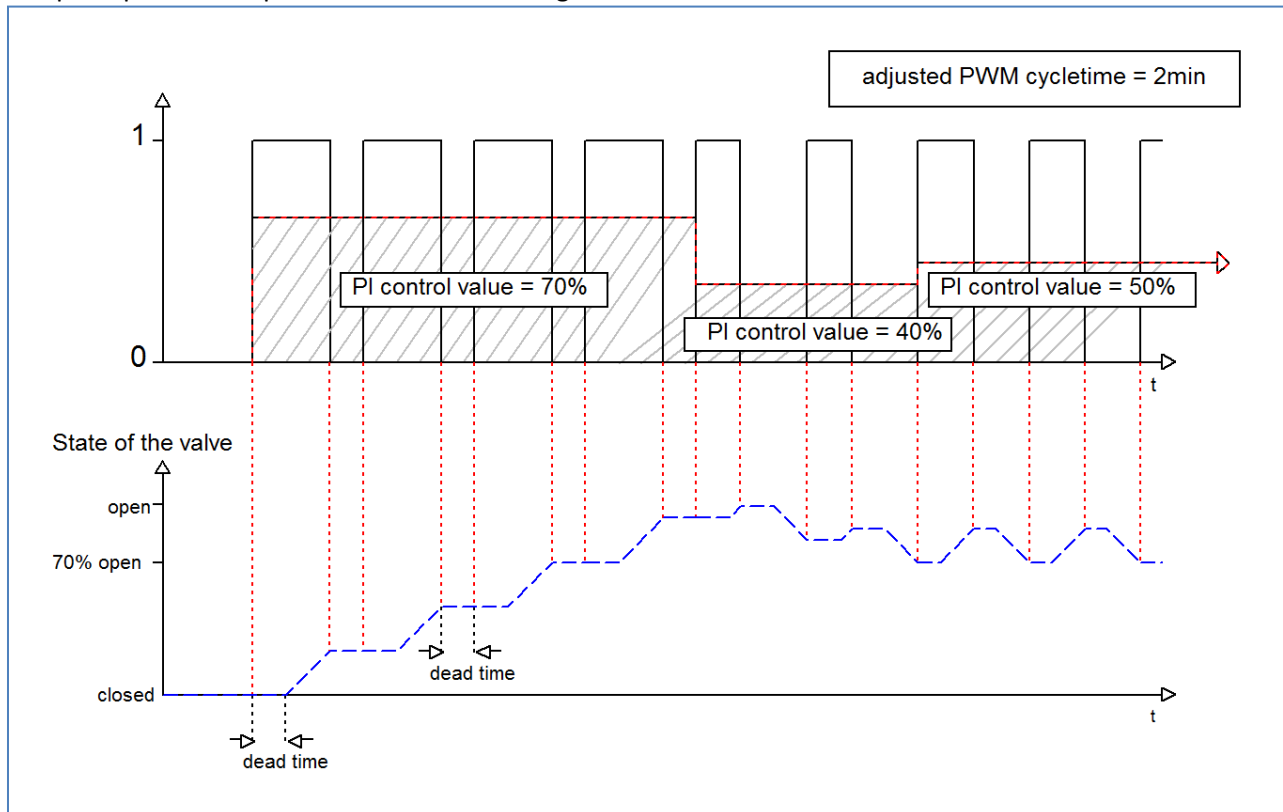

Figure 39: Diagram – PWM cycle time (2)

Here, too, the total adjustment cycle time is about 3 min. However, the valve can only make small deflections during the control and not the entire amplitude as in the previous settings. At the beginning, no movement takes place within the switch-off pulse of the PWM control, as the dead time of the valve here is just as long as the activation of the valve. This means that the valve continues to open continuously. If the temperature in the room exceeds the set value, the temperature controller readjusts the control value and thus the PWM pulse is set again. In the long term, this setting achieves an almost constant value for the valve position.

It should also be noted with this setting that the dead times will decrease due to the permanently flowing warm water in the control valve and thus the actual travel times will increase within the pulse. However, since the temperature controller reacts dynamically, it will respond to this change with a changed control value and thus also achieve an almost constant valve position. The advantage of this setting is that the control valves are not overloaded and the temperature in the room is hardly subject to fluctuations due to the continuous adjustment of the control value. However, if several valves are controlled, the average value for the valve position can hardly be achieved and thus fluctuations in the room temperature can occur.

This setting has become established especially in fast systems where only one control valve is controlled, e.g., radiators.

4.6.3.3 Limitation of control value

The following settings are available:

ETS-Text	Dynamic range [Default value]	Comment
Minimum limitation of control value	0 – 50% [0%]	Determination of the minimum limitation of the control value. Visible for “Heating” or “Cooling”.
Maximum limitation of control value	20 – 100% [100%]	Determination of the maximum limitation of the control value. Visible for “Heating” or “Cooling”.
Minimum limitation of control value during Heating/Cooling	0 – 50% [0%]	Determination of the minimum limitation of the control value. Visible for “Heating and Cooling”.
Maximum limitation of control value during Heating/Cooling	20 – 100% [100%]	Determination of the maximum limitation of the control value. Visible for “Heating and Cooling”.
Limitation via object	<ul style="list-style-type: none"> ▪ not active ▪ active for 1 h ▪ active for 24 h 	Activates an override of the minimum or maximum control value for a certain time.

Table 81: Settings – Limitation of control value

The control value limitation limits the value of the control value that is passed on to the PWM signal. With an active control value limitation, i.e., minimum>0% or maximum<100%, the input signal, insofar as it lies outside the limitation, is raised/lowered to the corresponding limit. The pulses for the PWM signal are then calculated from this value.

Example: In Heating mode, the maximum limitation is set to 70% and the minimum limitation to 10%. The PWM cycle is 10 min. If a control value of 100% is sent, the channel assumes the maximum limitation of 70% and calculates the "switch-on pulse" of 7 min. A control value within the limitation behaves normally, i.e., a control value of 50% also leads to a "switch-on pulse" of 5 min.

The control value limits can be set individually for Heating and Cooling mode. The minimum limitation of the control value is designed so that a control value of 0% is not limited and leads to a control value of 0%. Any control value above 0% but below the minimum limitation leads to the set value. This behaviour makes sense for reasons of energy saving, as otherwise the control valve would constantly consume the limitation value of the nominal power even when not in use.

With the setting "**Limitation over object**", two new objects are displayed. By sending a percentage value to the corresponding communication object, either the minimum or the maximum control value can be limited for the set time.

Example: In the morning, the floor heating in the bathroom is to be limited to a minimum of 30% for 1 hour. This means that the floor is "foot warm" for this time. After the time has elapsed, the configured limitation values apply again.

The following communication objects are available for this:

Number	Name	Length	Usage
33	Override: Minimum control value	1 Byte	Sending a control value for minimum limitation for a set time
34	Override: Maximum control value	1 Byte	Sending a control value for maximum limitation for a set time

Table 82: Communication objects – Limitation of control value

4.6.3.4 Control value when falling below the minimum limitation

The following table shows the available settings:

ETS-Text	Dynamic range [Default value]	Comment
Control value when falling below the minimum limitation	<ul style="list-style-type: none">▪ 0% = 0%, otherwise use minimum set value▪ 0% = minimum set value	Setting of what is to happen at a control value of 0%.

Table 83: Settings – Control value when falling below the minimum limitation

The parameter defines the behaviour when the channel receives a control value of 0%:

- **0% = 0%, otherwise use minimum set value**
When receiving a control value of 0%, the channel sets the channel to permanently off, i.e. the 0% is actually interpreted as this.
- **0% = minimum set value**
When a control value of 0% is received, the channel sets the channel to the set minimum control value. For example, if a control value of 0% is received and the minimum control value is set to 10%, the channel calls up the settings for 10%.

4.6.3.5 Object valve status

The following table shows the available settings:

ETS-Text	Dynamic range [Default value]	Comment
Object valve status	<ul style="list-style-type: none"> ▪ valve status (1=open, 0=closed) ▪ 1, if control value > 0% 	Setting how the valve status is displayed via object.

Table 84: Settings – Object valve status

valve status (1=open, 0=closed):

In this setting, the actual valve status is sent via a 1-bit object.

Example:

PWM cycle 10 minutes

Control value 10%

Within the PWM cycle of 10 minutes, the valve status "1" is sent for 1 minute (=10%), and the valve status "0" for 9 minutes. Please note that the "1" does not appear at the beginning, but at some point during the cycle.

1, if control value > 0%:

With this setting, a "1" is sent as soon as the incoming control value is greater than 0%. It is irrelevant whether the value is 1% or 100%. As soon as a control value with a value of "0%" is received, the status sends a "0".

The following communication objects are available for this:

Number	Name	Length	Usage
14	Control value > 0%: Send status	1 Bit	Sending the status
15	Send valve status	1 Bit	Sending the status
15	Send valve status Heating	1 Bit	Sending the status for Heating. Only available with "Heating and Cooling" and "2 pipe system" *

Table 85: Communication objects – Valve status

*** Important:**

In the "Heating and Cooling" operating mode, the current electrical output of the channel is always the "Heating" output! Therefore, only the valve status for "Heating" is sent on object 15!

4.6.3.6 Forced position/Dew point alarm

A forced position (in Heating- as well as in Cooling mode) or a dew point alarm (only in Cooling mode) can be activated for each channel.

The following table shows the relevant settings:

ETS-Text	Dynamic range [Default value]	Comment
Forced position	<ul style="list-style-type: none"> ▪ not active ▪ active 	Activation of a forced position. Only available with "Heating"
Forced position/ Dew point alarm	<ul style="list-style-type: none"> ▪ not active ▪ Forced position ▪ Dew point alarm (control value = 0%) 	Setting whether a forced position or dew point alarm is to be activated. Only available with "Cooling"
Control value for forced position	0 – 100 % [0 %]	Setting of a fixed actuating value when forced position has been activated

Table 86: Settings – Forced position/Dew point alarm

The **forced position** can set the control value to a fixed state with values from 0-100% when activated. The channel operates in an active forced position as a PWM controller with a fixed cycle time of 10 minutes. The forced position is activated by a "1" signal" to the associated object. If a "0" is sent, the channel falls back into its old state or adopts the last received value for the control value. The following communication object is available for this:

Number	Name	Length	Usage
32	Forced position	1 Bit	Activation/deactivation of the forced position

Table 87: Communication object – Forced position

If the channel is in the operating mode "Cooling", a **dew point alarm** can be activated.

By activating it, an additional object is displayed as shown in the table below. Sending a "1" activates the dew point alarm, thereby setting the control value permanently to 0%. A "0" deactivates the dew point alarm and the channel operates normally.

The following communication object is available for this:

Number	Name	Length	Usage
32	Dew point alarm	1 Bit	Activation/deactivation of the dew point alarm

Table 88: Communication object – Dew point alarm

4.6.3.7 Additional sensor for flow temperature

This parameter is only available in the operating mode "Heating" or "Heating and cooling"!

The following settings are available (Here for setting "Heating"):

Additional sensor for flow temperature	<input type="radio"/> not active <input checked="" type="radio"/> active
Maximum flow temperature Heating	40 °C
Minimum limit of flow temperature	<input type="radio"/> not active <input checked="" type="radio"/> active
Minimum flow temperature Heating	20 °C
Enabled for Comfort	<input type="radio"/> not active <input checked="" type="radio"/> active
Enabled for Standby	<input checked="" type="radio"/> not active <input type="radio"/> active
Enabled for Night	<input checked="" type="radio"/> not active <input type="radio"/> active
Enabled for Frost/Heat protection	<input checked="" type="radio"/> not active <input type="radio"/> active

Figure 40: Settings – Additional sensor for flow temperature

The following table shows the relevant settings:

ETS-Text	Dynamic range [Default value]	Comment
Additional sensor for flow temperature	<ul style="list-style-type: none"> ▪ not active ▪ active 	Activation/deactivation of a flow temperature limitation.
Maximum flow temperature during Heating	0 ... 60°C [40°C]	Setting a maximum flow temperature.
Minimum limit of flow temperature	<ul style="list-style-type: none"> ▪ not active ▪ active 	Activation/deactivation of the minimum flow temperature limitation.
Minimum flow temperature during Heating	0 ... 60°C [20°C]	Setting a minimum flow temperature.
Enabled for Comfort	<ul style="list-style-type: none"> ▪ not active ▪ active 	The respective parameter can be used to set the operating mode in which the flow temperature limitation is to be effective.
Enabled for Standby	<ul style="list-style-type: none"> ▪ not active ▪ active 	
Enabled for Night	<ul style="list-style-type: none"> ▪ not active ▪ active 	
Enabled for Frost/Heat protection	<ul style="list-style-type: none"> ▪ not active ▪ active 	

Table 89: Settings – Additional sensor for flow temperature

With this parameter, the current flow temperature can be limited. This makes it possible to limit the heating temperature as required in certain situations. If, for example, a floor heating system is not to heat above a certain value in order to protect the floor coverings, the heating temperature can be limited by the maximum flow temperature.

The minimum flow limitation can be used, for example, to keep the bathroom floor at a comfortable temperature.

The flow temperature limitation requires a second sensor that is installed in the floor/screed and detects the floor temperature.

The following communication object is available for this purpose:

Number	Name	Length	Usage
26	Receive flow temperature heating	2 Byte	Input of an external temperature reading

Table 90: Communication object – Additional sensor for flow temperature

4.6.3.8 Additional sensor for cooling medium

This parameter is only available in the operating mode "Cooling" or "Heating and cooling"!

The following settings are available:

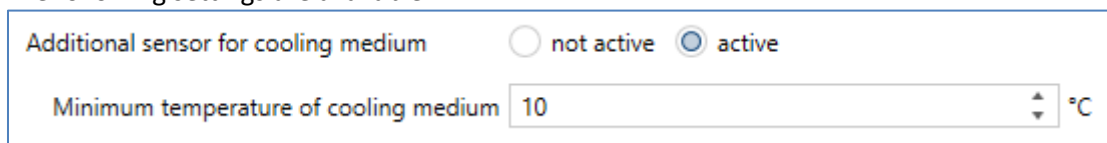

Figure 41: Settings – Additional sensor for cooling medium

The following table shows the possible settings:

ETS-Text	Dynamic range [Default value]	Comment
Additional sensor for cooling medium	<ul style="list-style-type: none"> ▪ not active ▪ active 	Activation of an additional sensor.
Minimum temperature of cooling medium	0 ... 60°C [10°C]	Setting a minimum temperature.

Table 91: Settings – Additional sensor for cooling medium

This parameter determines the temperature threshold above which the control value of the cooling channel is regulated back. This can prevent unwanted condensation. For this purpose, another temperature sensor is required, which is placed at the coolest point of the air conditioner.

The following communication object is available:

Number	Name	Length	Usage
27	Receive surface temperature Cooling	2 Byte	Input of an external temperature reading

Table 92: Communication object – Additional sensor for cooling medium

4.6.3.9 Emergency mode

The following picture shows the possible settings:

ETS-Text	Dynamic range [Default value]	Comment
Emergency mode	<ul style="list-style-type: none"> ▪ not active ▪ active 	Activation/deactivation of emergency operation.
Emergency mode on failure of temperature value after...	30 ... 90 Minutes [30]	Setting from when emergency operation is to start.
Control value for emergency mode Heating	0 – 100 % [50 %]	Setting a fixed control value while emergency operation in Heating mode is active.
Control value for emergency mode Cooling	0 – 100 % [50 %]	Setting a fixed control value while emergency operation in Cooling mode is active.

Table 93: Settings – Emergency mode

Emergency mode can be activated for each channel. The setting "**Emergency mode on failure of temperature value after**" can be used to set from when emergency operation is to be activated. The input object for the measured temperature value needs a cyclical pulse. If this signal remains absent for the configured time, emergency operation is activated. For this purpose, a fixed "**control value for emergency mode**" can be set for both "Heating"- and "Cooling operation" from 0-100%. The Heating Actuator operates in emergency mode in PWM mode with a fixed cycle time of 10 minutes. The corresponding status LED on the actuator signals emergency operation by flashing 2x - pause - flashing 2x etc.

Emergency operation prevents the heating/cooling from being permanently operated at 100%, for example, or from cooling down or overheating at low temperatures if a temperature sensor fails. As soon as a measured value is received again, the channel exits emergency mode and continues to operate normally. The monitoring time starts anew after each reception of a measured temperature value.

4.6.3.10 Lock objects

For each channel, a lock object is available for the control value in heating mode and in cooling mode. These can be used either as lock or enable objects.

The following table shows the possible settings:

ETS-Text	Dynamic range [Default value]	Comment
Lock object for control value Heating	<ul style="list-style-type: none"> ▪ not active ▪ active, enable object ▪ active, lock object 	Activation of a lock or enable object for heating operation
Lock object for control value Cooling	<ul style="list-style-type: none"> ▪ not active ▪ active, enable object ▪ active, lock object 	Activation of a lock or enable object for cooling operation

Table 94: Settings – Lock objects

The respective channel can be locked for further operation by means of the **lock object**. Locking is triggered by sending a logical "1" to the lock object. The locking process is only cancelled again by sending a logical "0". When the locking function is activated, the channel is switched off (control value=0%). After deactivating the locking process, the channel returns to its original value. If telegrams are sent to the locked channel during an active locking process, this does not lead to any change. The channel assumes the value of the last telegram after the locking process is cancelled. When setting as an **enable object**, it is exactly the other way round. With a "1", normal operation is enabled, with a "0", the channel is locked.

Important:

After a restart of the Heating Actuator, each channel is in normal operation, even if the object is configured as an enable object. Thus, the channel must receive a "0" first to be locked and then a "1" to be enabled.

The following communication objects are available for this:

Number	Name	Length	Usage
30	Lock object Heating: Lock control value	1 Bit	Activating/deactivating a lock
30	Enable object Heating: Enable control value	1 Bit	Activation/deactivation of an enablement
31	Lock object Cooling: Lock control value	1 Bit	Activating/deactivating a lock
31	Enable object Cooling: Enable control value	1 Bit	Activation/deactivation of an enablement

Table 95: Communication objects – Lock-/Enable objects

4.6.3.11 Send diagnosis text

The following table shows the available sending conditions for the diagnosis text:

ETS-Text	Dynamic range [Default value]	Comment
Send diagnosis text	<ul style="list-style-type: none"> ▪ not active ▪ send on request ▪ send on change 	Activation and definition of the sending condition for a diagnosis text via object

Table 96: Settings – Diagnosis text

Each channel can send a diagnosis text about the current status. The sending condition can be defined.

The description of the diagnosis texts can be found under: [4.1.8.1 Diagnosis texts as plain text.](#)

The following communication object is available for this:

Number	Name	Length	Usage
28	Diagnosis status	1 Bit	Sending the diagnosis text

Table 97: Communication object – Diagnosis text

4.7 Scenes

With a scene, it is possible to carry out several actions in different trades (e.g., light, heating, roller shutter) simultaneously with one press of a button or one operating command. All this happens with one telegram.

With the help of the scene function of the MDT Heating Actuator, the channels can be integrated into a scene control.

The scene function is available once per unit and can cause an operating mode changeover or pre-setting of a new setpoint for one or more channels.

4.7.1 Activate scenes

Up to 16 scenes can be activated:

Scene A	<input type="radio"/> inactive	<input checked="" type="radio"/> active
Scene B	<input checked="" type="radio"/> inactive	<input type="radio"/> active
Scene C	<input checked="" type="radio"/> inactive	<input type="radio"/> active
Scene D	<input checked="" type="radio"/> inactive	<input type="radio"/> active
Scene E	<input checked="" type="radio"/> inactive	<input type="radio"/> active
Scene F	<input checked="" type="radio"/> inactive	<input type="radio"/> active
Scene G	<input checked="" type="radio"/> inactive	<input type="radio"/> active
Scene H	<input checked="" type="radio"/> inactive	<input type="radio"/> active
Scene I	<input checked="" type="radio"/> inactive	<input type="radio"/> active
Scene J	<input checked="" type="radio"/> inactive	<input type="radio"/> active
Scene K	<input checked="" type="radio"/> inactive	<input type="radio"/> active
Scene L	<input checked="" type="radio"/> inactive	<input type="radio"/> active
Scene M	<input checked="" type="radio"/> inactive	<input type="radio"/> active
Scene N	<input checked="" type="radio"/> inactive	<input type="radio"/> active
Scene O	<input checked="" type="radio"/> inactive	<input type="radio"/> active
Scene P	<input checked="" type="radio"/> inactive	<input type="radio"/> active

Figure 42: Settings – Activate scenes

For each activated scene, a new submenu appears in which the respective scene can be further configured.

4.7.2 Submenu – Scene

The following settings are available here (here using the example AKH-0400.03):

Scene number	1
Operating mode	no change
Setpoint setting	no change
Scene valid for channel A	<input type="radio"/> not active <input checked="" type="radio"/> active
Scene valid for channel B	<input checked="" type="radio"/> not active <input type="radio"/> active
Scene valid for channel C	<input checked="" type="radio"/> not active <input type="radio"/> active
Scene valid for channel D	<input checked="" type="radio"/> not active <input type="radio"/> active

Figure 43: Settings – Submenu: Scene

The following table shows the possible settings:

ETS-Text	Dynamic range [Default value]	Comment
Scene number	1 – 64 [1]	Setting the scene number to which the actuator should react.
Operating mode	<ul style="list-style-type: none"> ▪ no change ▪ Comfort ▪ Standby ▪ Night ▪ Frost/Heat protection 	Setting an operating mode by calling up this scene.
Setpoint setting	no change 7 / 7,5 / 8 / 8,5 25 °C	Setting a specific setpoint by calling up this scene. Only with “Operating mode” – “no change”.
Change for channel X	<ul style="list-style-type: none"> ▪ not active ▪ active 	Setting which channel is to react to the scene call-up.

Table 98: Settings – Submenu: Scene

Either the operating mode or a setpoint can be changed via a scene. As soon as an operating mode is selected via parameters, the "Setpoint setting" parameter is hidden, since a setpoint is already assigned with the operating mode according to the configuration in the controller. The setting "Operating mode - no change" allows a fixed setpoint to be sent via "Setpoint setting". It is then possible to set for which channels the scene is valid.

Important: Scenes have the numbers 1 - 64, but the values for calling up the scene are only 0 - 63. Consequently, the value for calling must always be one number lower than the set scene number. If, for example, scene 1 is to be called up, the value "0" must be sent.

The following communication object is available for this purpose:

Number	Name	Length	Usage
*	Scene	1 Byte	Activate the respective scene.

Table 99: Communication object – Scene

* Central objects are at the end of the list. The object number is therefore different, depending on the number of channels. For the AKH-0400.03 it is no. 172, for the AKH-0600.03 no. 252 and for the AKH-0800.03 it is no. 332.

5 Index

5.1 Register of illustrations

Figure 1: Connection diagram – AKH-0600.03	8
Figure 2: Connection diagram – AKH-0800.03	8
Figure 3: Overview – Hardware modules	9
Figure 4: General settings.....	14
Figure 5: Settings – Basic configuration	15
Figure 6: Settings – Operating mode / Heating system / Switchover.....	17
Figure 7: Diagram – 2 pipe system.....	18
Figure 8: Diagram – 4 pipe system.....	18
Figure 9: Settings – Summer/Winter mode	19
Figure 10: Settings – Setpoints Frost/Heat protection.....	21
Figure 11: Settings – Object max. control value	22
Figure 12: Settings – Requirement for Heating/Cooling	23
Figure 13: Settings – Behaviour after bus power reset.....	25
Figure 14: Setting – Language for diagnosis text.....	26
Figure 15: Settings – Channel selection	28
Figure 16: Settings – Text fields per channel	29
Figure 17: Setting – Controller type.....	30
Figure 18: Basic settings – Controller type “switching 1 Bit”	31
Figure 19: Settings – Channel: Output (switching 1 Bit)	32
Figure 20: Basic settings – Controller type “continuous 1 Byte”.....	36
Figure 21: Settings – Channel: Output (continuous 1 Byte)	37
Figure 22: Diagram – PWM cycle time (1).....	40
Figure 23: Diagram – PWM cycle time (2).....	41
Figure 24: Settings – Additional sensor for flow temperature	46
Figure 25: Settings – Additional sensor for cooling medium.....	47
Figure 26: Basic settings – Controller type “integrated controller”	50
Figure 27: Settings – Controller	54
Figure 28: Settings – Setpoints for Standby/Night.....	55
Figure 29: Example – Dead zone and corresponding setpoints.....	57
Figure 30: Settings – Comfort extension with time.....	64
Figure 31: Settings – HVAC status objects	66
Figure 32: Settings – Reference control via outside temperature.....	68
Figure 33: Example – Reference control/decrease	69
Figure 34: Example – Reference control/increase.....	69
Figure 35: Settings – Alarms	71
Figure 36: Settings – Window contact	72
Figure 37: Settings – Channel: Output (integrated controller).....	74
Figure 38: Diagram – PWM cycle time (1).....	77
Figure 39: Diagram – PWM cycle time (2).....	78
Figure 40: Settings – Additional sensor for flow temperature	83
Figure 41: Settings – Additional sensor for cooling medium.....	84
Figure 42: Settings – Activate scenes.....	87
Figure 43: Settings – Submenu: Scene	88

5.2 List of tables

Table 1: Communication objects – Standard settings per channel	12
Table 2: Communication objects – Central objects	13
Table 3: Settings – Basic configuration	15
Table 4: Communication objects – Basic configuration	16
Table 5: Settings – Operating mode / Heating system / Switchover	17
Table 6: Settings – Summer/Winter mode	19
Table 7: Communication objects – Summer/Winter mode	20
Table 8: Settings – Setpoints Frost/Heat protection	21
Table 9: Settings – Object max. control value	22
Table 10: Communication objects – Object max. control value	22
Table 11: Settings – Requirement for Heating/Cooling	23
Table 12: Communication objects – Requirement for Heating/Cooling	24
Table 13: Settings – Behaviour after bus power reset	25
Table 14: Overview – Diagnosis text as plain text	27
Table 15: Settings – Channel selection	28
Table 16: Settings – Controller type	30
Table 17: Basic settings – Controller type “switching 1 Bit”	31
Table 18: Settings – Channel: General	32
Table 19: Communication object – Send valve state	33
Table 20: Settings – Forced position/Dew point alarm	33
Table 21: Communication object – Forced position	33
Table 22: Communication object – Dew point alarm	33
Table 23: Settings – Emergency mode	34
Table 24: Settings – Lock objects	34
Table 25: Communication objects – Lock-/Enable objects	35
Table 26: Settings – Diagnosis text	35
Table 27: Communication object – Diagnosis text	35
Table 28: Basic settings – Controller type “continuous 1 Byte”	36
Table 29: Settings – Channel: General	38
Table 30: Communication objects – Send valve state	38
Table 31: Settings – PWM cycle time	39
Table 32: Settings – Limitation of control value	42
Table 33: Communication objects – Limitation of control value	42
Table 34: Settings – Control value when falling below the minimum limitation	43
Table 35: Settings – Object valve status	44
Table 36: Communication objects – Object valve status	44
Table 37: Settings – Forced position/Dew point alarm	45
Table 38: Communication object – Forced position	45
Table 39: Communication object – Dew point alarm	45
Table 40: Settings – Additional sensor for flow temperature	46
Table 41: Communication object – Additional sensor for flow temperature	46
Table 42: Settings – Additional sensor for cooling medium	47
Table 43: Communication object – Additional sensor for cooling medium	47
Table 44: Settings – Emergency mode	48
Table 45: Settings – Lock objects	48
Table 46: Communication objects – Lock-/Enable objects	49
Table 47: Settings – Diagnosis text	49
Table 48: Communication object – Diagnosis text	49

Table 49: Basic settings – Controller type “integrated controller”	51
Table 50: Communication object – Additional level.....	53
Table 51: Settings – Operating modes & setpoints (depending on setpoint Comfort).....	55
Table 52: Communication object – Operating mode “Comfort”	56
Table 53: Communication object – Operating mode “Night”	56
Table 54: Communication objects – Operating mode “Frost/Heat protection”	56
Table 55: Setting – Dead zone.....	57
Table 56: Settings – Operating modes and Setpoints (independent setpoints).....	58
Table 57: Setting – Priority of the operating modes.....	59
Table 58: Example – Mode selection via 1 Bit	59
Table 59: Hex values of HVAC Modes	60
Table 60: Example – Mode selection via 1 Byte.....	60
Table 61: Communication objects – Mode selection	60
Table 62: Settings – Setpoint shift.....	61
Table 63: Communication objects – Setpoint changes.....	63
Table 64: Settings – Comfort extension with time.....	64
Table 65: Communication object – Comfort extension with time	64
Table 66: Settings – Operating mode after reset	65
Table 67: Settings – HVAC status objects	66
Table 68: Assignment – DPT HVAC Status	66
Table 69: Assignment – DPT RHCC Status.....	67
Table 70: Assignment – RTC combined status DPT 22.103.....	67
Table 71: Assignment – RTSM combined status DPT 22.107.....	68
Table 72: Settings – Reference control via outside temperature	68
Table 73: Communication object – Reference control via outside temperature	70
Table 74: Settings – Alarms	71
Table 75: Communication objects – Alarms	71
Table 76: Settings – Window contact.....	72
Table 77: Communication object – Window contact	73
Table 78: Settings – Channel: General.....	75
Table 79: Communication objects – Send valve state.....	75
Table 80: Settings – PWM cycle time.....	76
Table 81: Settings – Limitation of control value.....	79
Table 82: Communication objects – Limitation of control value.....	79
Table 83: Settings – Control value when falling below the minimum limitation	80
Table 84: Settings – Object valve status.....	81
Table 85: Communication objects – Valve status	81
Table 86: Settings – Forced position/Dew point alarm	82
Table 87: Communication object – Forced position	82
Table 88: Communication object – Dew point alarm.....	82
Table 89: Settings – Additional sensor for flow temperature.....	83
Table 90: Communication object – Additional sensor for flow temperature	84
Table 91: Settings – Additional sensor for cooling medium	84
Table 92: Communication object – Additional sensor for cooling medium	84
Table 93: Settings – Emergency mode.....	85
Table 94: Settings – Lock objects	85
Table 95: Communication objects – Lock-/Enable objects.....	86
Table 96: Settings – Diagnosis text.....	86
Table 97: Communication object – Diagnosis text	86
Table 98: Settings – Submenu: Scene	88
Table 99: Communication object – Scene.....	88

6 Appendix

6.1 Statutory requirements

The devices described above must not be used in conjunction with devices that directly or indirectly serve human, health, or life-safety purposes. Furthermore, the devices described must not be used if their use may cause danger to people, animals or property.

Do not leave packaging material lying around carelessly. Plastic foils/ bags etc. can become a dangerous toy for children.

6.2 Disposal

Do not dispose of the old equipment in the household waste. The device contains electrical components that must be disposed of as electronic waste. The casing is made of recyclable plastic.

6.3 Assembly



Danger to life due to electric current!

The device may only be installed and connected by qualified electricians. Observe the country-specific regulations and the applicable KNX guidelines.

The units are approved for operation in the EU and bear the CE mark.
Use in the USA and Canada is not permitted!

After the device has been installed and the mains voltage has been switched on, voltage may be present at the outputs.

When installed, a KNX bus telegram can switch the outputs to live at any time.

Before starting work on the unit, always disconnect it from the mains via the upstream fuses.

After installation, all live terminals and connections must be completely closed by the control panel cover to prevent accidental contact. It must not be possible to open the control panel cover without tools.

6.4 Revision history

V1.0	First version, "3 rd generation" of Heating Actuators	DB V3.0	07/2021
V1.1	General adaptations, new database	DB V3.1	02/2022