



KLIC-LG1

**KNX – RYB
for LG A/C Units**

ZCL-LG1

Application program version: [1.0]

User manual edition: [1.0]_b

www.zennio.com

CONTENTS

Contents	2
Document Updates	3
1 Introduction	4
1.1 KLIC-LG1	4
1.2 Installation.....	5
1.3 Start-Up and Power Loss	6
2 Configuration.....	7
2.1 General.....	7
2.2 Inputs	10
2.2.1 Binary Input.....	10
2.2.2 Temperature Probe.....	11
2.2.3 Motion Detector	11
2.3 Logic Functions.....	12
2.4 A/C Gateway	13
2.4.1 Configuration	13
2.4.2 Fan.....	21
2.4.3 Flaps	22
2.4.4 Initial Configuration	24
2.4.5 Scenes	26
2.4.6 Error Handling.....	27
ANNEX I. Communication Objects.....	29

DOCUMENT UPDATES

Version	Changes	Page(s)
[1.0]_b	<ul style="list-style-type: none"><li data-bbox="469 443 743 472">• Minor corrections	-

1 INTRODUCTION

1.1 KLIC-LG1

KLIC-LG1 from Zennio is a gateway that provides full-duplex communication between the KNX home automation system and **LG air-conditioning** systems through the 3-wire gateway provided.

Because of this **bidirectional** communication, the air conditioning system can be controlled from the home automation system in the same manner as it is through its own controls. Moreover, the actual status of the unit can be monitored and periodically sent to the KNX bus to inform other devices.

The most outstanding features of KLIC-LG1 are:

- **Bidirectional control** of LG A/C units through the connection wires provided by LG: **R** (supply voltage, 12V), **Y** (communication), **B** (GND).
- Control of **the main functions** of the A/C unit: On/Off, temperature, mode of operation, fan speed, position of the flaps, etc.
- **Error management** to handle specific error codes from the A/C unit itself as well as any communication issues that may arise.
- Up to **five scenes**.
- **Three analogue-digital inputs**, for the connection of temperature probes, motion detectors or binary pushbuttons or switches.
- 10 customisable, multi-operation **logic functions**.
- **Heartbeat** or periodical “still-alive” notification.

1.2 INSTALLATION

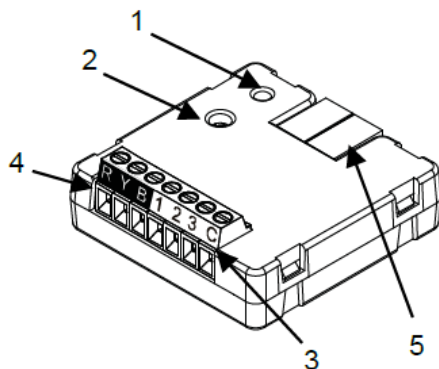

1. Prog./Test LED indicator
2. Prog./Test button
3. Analogue/digital inputs
4. Terminal connection RYB.
5. KNX connector

Figure 1. Element scheme.

KLIC-LG1 connects to the KNX bus via the corresponding built-in terminal (5). Once the device is provided with power from the KNX bus, both the physical address and the KLIC-LG1 application program can be downloaded.

This device does not need any external power as it is entirely powered through the KNX bus.

The remaining elements are described next.

- **Prog./Test button (2):** a short press on this button will set the device into the programming mode, making the associated LED (1) light in red.

Note: if this button is held while plugging the device into the KNX bus, the device will enter into safe mode. The LED will blink in red every 0.5 seconds

- **Analogue-Digital Inputs (3):** input ports for the stripped cables of external elements such as switches, motion detectors, temperature probes, etc.
- **Terminal connection, RYB (4):** wires that will connect KLIC-LG1 to the A/C unit. The other end of the cable, therefore, is intended to be connected to the corresponding connectors in the PCB board of the internal unit.

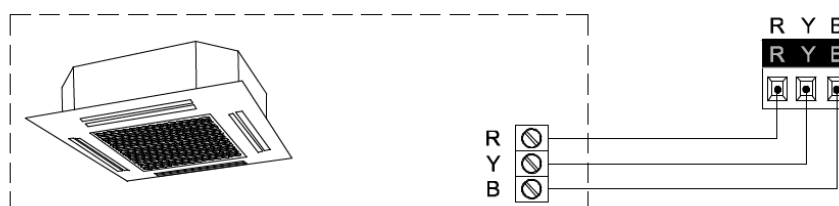

Figure 2. Connecting KLIC-LG1 to the A/C unit.

Important:

- *If intending to control the A/C unit both through its incorporated wired remote control and through KLIC-LG1, it must be taken into account that orders sent from the wired remote control will have a higher priority than those sent through KLIC-LG1.*
- *If there are several indoor units connected to a single outdoor unit, all of them must work in the same mode (heating or cooling). If they work in opposite modes, the CH 07 error will appear.*

For detailed information about the technical features of KLIC-LG1, as well as on security and installation procedures, please refer to the device **Datasheet**, bundled in the device packaging and also available at <http://www.zennio.com>.

1.3 START-UP AND POWER LOSS

Depending on the configuration, some specific actions will be performed during the device start-up. The integrator may set up an initial status to be sent to the A/C unit after the bus power recovery, and whether certain objects should be sent to the bus after the power recovery, as described in later sections.

On the other hand, when a bus power failure takes place, the device will interrupt any pending actions, and will save its state so it can be recovered once the power supply is restored.

Notes:

- *After a bus power failure, it can take up to a minute to establish the connection between KLIC-LG1 and the A/C unit.*
- *The configuration of the remote wired control will be sent if this control is plugged after KLIC-LG1.*

2 CONFIGURATION

2.1 GENERAL

The general configuration of the device consists in enabling the specific functionalities that will be required during normal operation:

- **Heartbeat** or periodical “still-alive” notification.
- **Inputs**: see section 2.2.
- **Logic functions**: see section 2.3.
- **AC gateway**: see section 2.4.

The latter entails all functions specific to KLIC-LG1, i.e., all the functions related to interfacing with the A/C unit and to the management of the climate control system.

ETS PARAMETERISATION

After importing the corresponding database in ETS and adding the device into the topology of the desired project, the configuration process begins by entering the Parameters tab of the device.

The General screen is shown in the first place, containing the following parameters:

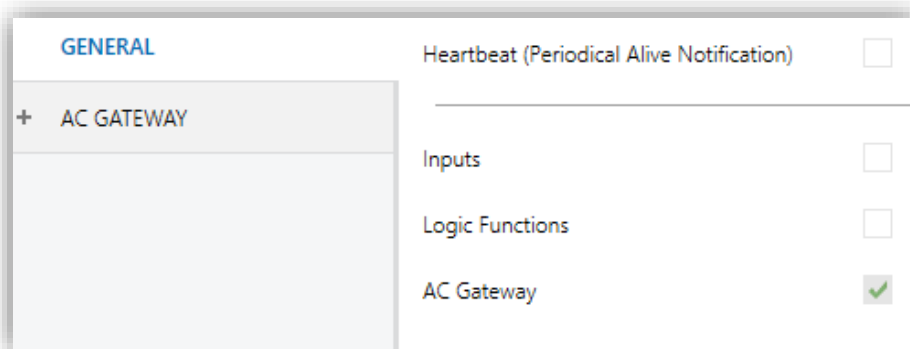
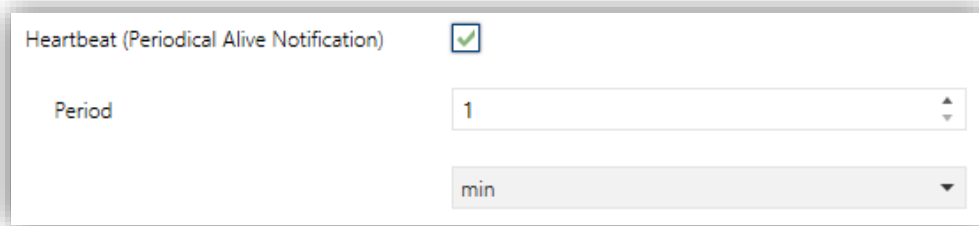

Figure 3. General.

- Enabling **Inputs**, **Logic Functions** and **AC Gateway** brings additional tabs into the menu on the left. These functions and their parameters will be explained in

later sections of this document. Please, note that **AC Gateway** is permanently enabled.

- **Heartbeat (Periodical Alive Notification)**: this parameter lets the integrator incorporate a 1-Bit object to the project (“**[Heartbeat] Object to Send ‘1’**”) that will be sent periodically with value “1” to notify that the device is still working (*still alive*).



Heartbeat (Periodical Alive Notification)

Period 1

min

Figure 4. Heartbeat.

Note: *The first sending after download or bus failure takes place with a delay of up to 255 seconds, to prevent bus overload. The following sendings match the period set.*

Regardless of the above parameters, the following objects are available by default:

- “[AC] On/Off” and “[AC] On/Off (Status)”: allow switching on (value “1”) and off (value “0”) the A/C unit or reading the current status, respectively.
- “[AC] Temperature Setpoint” and “[AC] Temperature Setpoint (Status)”: allow setting the desired temperature setpoint or reading the current value, respectively. See section 2.4.1 for further options.
- “[AC] Mode” and “[AC] Mode (Status)”: allow setting the desired operation mode (either Automatic, Heating, Cooling, Fan or Dry) or reading the current mode, respectively. See section 2.4.1 for further options.
- “[AC] Speed: Percentage Control” and “[AC] Speed Percentage control (Status)”: allow setting the desired speed or reading the current speed, respectively. See section 2.4.1 for further options.
- “[AC] Operating Time”: shows the time in hours that the A/C unit has been working. See section 2.4.1 for further options.

- “[AC] Reference Temperature (Status)”: shows the temperature that is being used by the A/C unit as reference. See section 2.4.1 for further options.
- Several **error objects**. See section 2.4.6.

2.2 INPUTS

KLIC-LG1 incorporates **three analogue/digital inputs**, each configurable as a:

- **Binary Input**, for the connection of a pushbutton or a switch/sensor.
- **Temperature Probe**, for the connection of a temperature sensor from Zennio.
- **Motion Detector**, for the connection of a motion detector (models ZN1IO-DETEC-P and ZN1IO-DETEC-X from Zennio).

Important: *older models of the Zennio motion detector (e.g., ZN1IO-DETEC and ZN1IO-DETEC-N) will not work properly with KLIC-LG1.*

ETS PARAMETERISATION

When **Inputs** has been activated in the General parameters screen, the following drop-down lists will be available for the selection of the specific functions required.

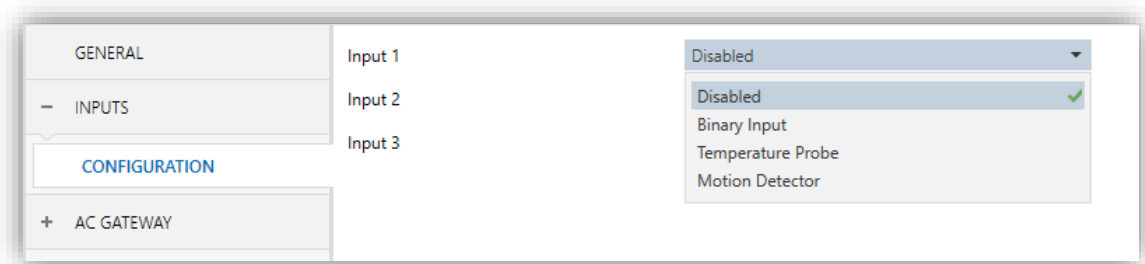

Figure 5. Inputs. Configuration.

All inputs are disabled by default. Depending on the function selected for each input, additional tabs will be included in the menu on the left.

2.2.1 BINARY INPUT

Please refer to the “**Binary Inputs**” user manual, available in the KLIC-LG1 product section, at the Zennio website (www.zennio.com).

2.2.2 TEMPERATURE PROBE

Please refer to the “**Temperature Probe**” user manual, available in the KLIC-LG1 product section, at the Zennio website (www.zennio.com).

2.2.3 MOTION DETECTOR

It is possible to connect motion detectors (models **ZN1IO-DETEC-P** and **ZN1IO-DETEC-X** from Zennio) to the input ports of KLIC-LG1.

Please refer to the “**Motion Detector**” user manual, available in the KLIC-LG1 product section, at the Zennio website (www.zennio.com).

Notes:

- *The ZN1IO-DETEC-P motion detector is compatible with a variety of Zennio devices. However, depending on the device it is actually being connected to, the functionality may differ slightly. Therefore, please refer specifically to the corresponding product section to obtain the aforementioned document.*
- *Motion detectors with references ZN1IO-DETEC and ZN1IO-DETEC-N are **not compatible** with KLIC-LG1 (may report inaccurate measurements if connected to this device).*
- *When connected to KLIC-LG1, the rear micro-switch of model ZN1IO-DETEC-P should be set to position “**Type B**”.*

2.3 LOGIC FUNCTIONS

This module makes it possible to perform numeric and binary operations with incoming values received from the KNX bus, and to send the results through other communication objects specifically enabled for this purpose.

KLIC-LG1 can implement **up to 10 different and independent functions**, each of them entirely customisable and consisting in **up to 4 consecutive operations each**.

The execution of each function can depend on a configurable **condition**, which will be evaluated every time the function is **triggered** through specific, parameterizable communication objects. The result after executing the operations of the function can also be evaluated according to certain **conditions** and afterwards sent (or not) to the KNX bus, which can be done every time the function is executed, periodically or only when the result differs from the last one.

Please refer to the “**Logic Functions**” user manual (available in the KLIC-LG1 product section at the Zennio homepage, www.zennio.com) for detailed information about the functionality and the configuration of the related parameters.

2.4 A/C GATEWAY

2.4.1 CONFIGURATION

KLIC-LG1 allows controlling and monitoring an air-conditioning unit in the same way it would be through the wired remote control it is provided with.

Through the KNX bus, KLIC-LG1 can be sent orders to control the following basic functions of the air conditioning unit:

- **Control configuration**, which allows establishing the type of master-slave control desired to KLIC-LG1.

- **On/Off** switch of the air-conditioning unit.

Note: *if the A/C unit is off, the received orders will be ignored.*

- **Operation mode:** automatic, heating, cooling, fan and dry.

Note: *due to intrinsic LG restrictions, in “Fan” and “Dry” modes, it is not possible to change the setpoint.*

- **Temperature setpoint**, which can be modified within a specific range of values, depending on the capabilities of the specific A/C unit being controlled.

- **External reference temperature** which purpose is to receive temperature values provided by an external temperature probe to perform the temperature control.

- **Fan speed:** 3 or 4, depending on the model of the A/C unit.

- **Control of flaps (or vanes) positioning:** step control, direct positioning, swing and swirl movement of horizontal and vertical flaps, depending on the A/C unit.

Moreover, KLIC-LG1 allows configuring several advanced functions:

- **Initial configuration**, which allows establishing the desired initial parameters for the state of the A/C unit after programming or restarting the device.

- **Setpoint limits**, to restrict the range for the temperature setpoint.

- **Operating time:** provides in hours the A/C unit operating time.
- **Automatic off,** which allows an automatic and temporary switch-off of the unit (after a pre-established delay, if desired) when the communication object associated to this function is triggered due to a certain event.
- **Scenes,** which allows defining specific climate control presets, to be sent to the machine on the reception of scene orders from the KNX bus.

These functionalities imply changes in the state of the A/C unit, which therefore notifies KLIC-LG1 periodically about the current state. When KLIC-LG1 is notified about a change, it updates the **status objects** and sends them to the KNX bus. In addition, KLIC-LG1 provides an **error management** function (see section 2.4.6), which allows sending messages to the KNX bus in case the A/C unit reports any errors.

ETS PARAMETRIZATION

The Configuration window under AC Gateway provides the following parameters:

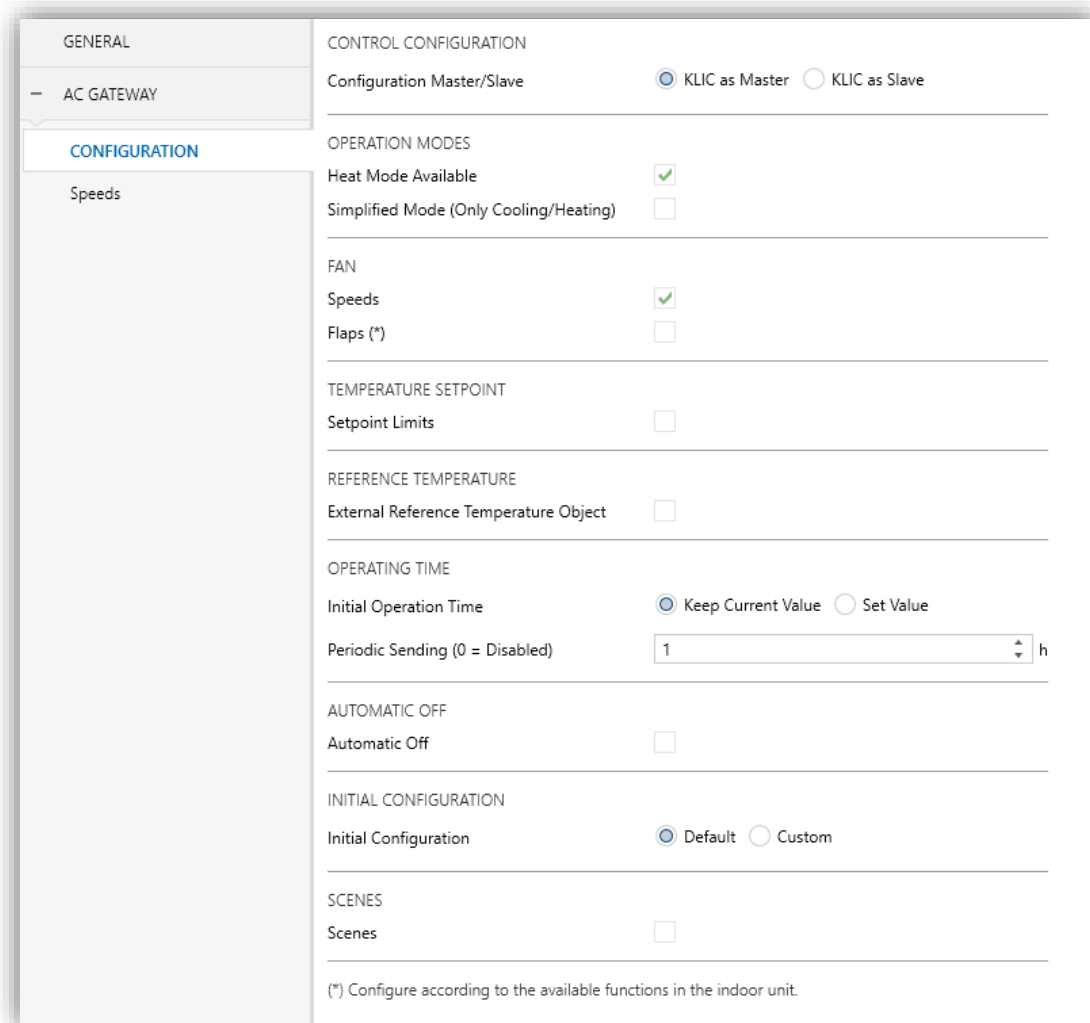

Figure 6: A/C Gateway. Configuration.

CONTROL CONFIGURATION

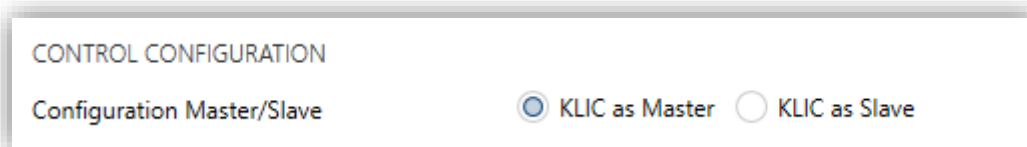

Figure 7: A/C Gateway. Configuration. Control Configuration.

- **Configuration Master/Slave:** allows configuring KLIC-LG1 as master or as slave. The objects “[AC] External Reference Temperature” and “[AC]

Reference Temperature (Status)” are available when KLIC has been parameterized as master.

Important: the master device has to be connected before plugging the slave device.

OPERATION MODES

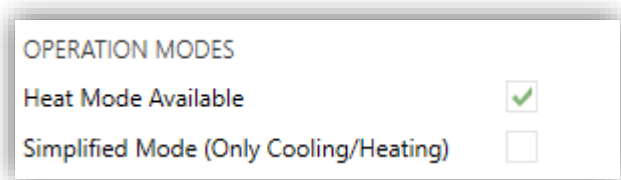

Figure 8: A/C Gateway. Configuration. Operation Modes.

KLIC-LG1 allows controlling the A/C unit operating mode through the following objects, available by default:

- “[AC] Mode”: 1-Byte object which allows selecting the A/C unit operation mode. There will be only taken in account values that are appropriated with some of available modes in LG units, which are represented in Table 1.
- “[AA] Mode (status)”: 1-Byte object which allows knowing the A/C unit operating mode status.

Object Value	A/C unit mode
0	Auto
1	Heating
3	Cooling
9	Fan only
14	Dry

Table 1. A/C unit operating modes.

In addition, it can be enabled by parameter:

- **Heat Mode Available:** if this checkbox is unchecked, the options relative to heat mode, automatic mode, maximum setpoint limit and simplified mode will disappear.

- **Simplified Mode:** in addition to the “**Mode**” and “**Mode (Status)**” 1-Byte objects, available by default, it is possible to commute and to verify the current operation mode through the following 1-Bit objects, which get enabled after activating this parameter:
 - “**Simplified Mode**”, which allows switching to the Cooling mode when receiving a “0” and to the Heating mode when receiving a “1”.
 - “**Simplified Mode (Status)**”, which will send the value “0” when the mode switches to Cooling or to Dry, or the value “1” when it switches to Heating. The Fan mode is not reflected in the value of this object.

FAN



Figure 9: A/C Gateway. Configuration. Fan.

- **Fan:** enables the Fan function. See section 2.4.2.
- **Flaps:** enables the fan Flaps function. See section 2.4.3.

REFERENCE TEMPERATURE

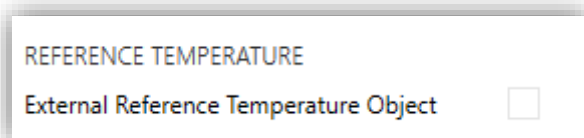
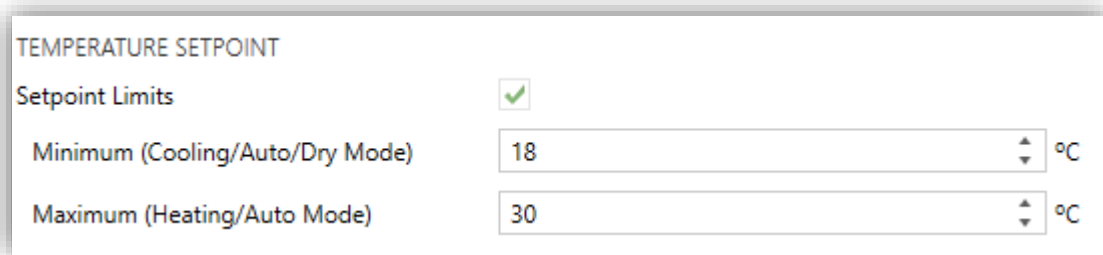

Figure 10: A/C Gateway. Configuration. Reference Temperature.

- **External Reference Temperature Object:** enables the “[AC] External Reference Temperature” 2-Byte object, which provides the value of an external temperature sensor, which is used by the AC machine as the reference to execute the control loop.

Note: *this option is only available if the KLIC is configured as master.*

TEMPERATURE SETPOINT



TEMPERATURE SETPOINT	
Setpoint Limits	<input checked="" type="checkbox"/>
Minimum (Cooling/Auto/Dry Mode)	<input type="text" value="18"/> °C
Maximum (Heating/Auto Mode)	<input type="text" value="30"/> °C

Figure 11: A/C Gateway. Configuration. Temperature Setpoint.

- **Setpoint Limits:** allows restricting the range of the temperature setpoint (from below in Cooling, Dry and Auto modes and from above in Heating and Auto modes), provided that the limits are still within the predefined limits of the A/C unit. When KLIC-LG1 receives an order to send the A/C unit a setpoint which is greater or lower than the configured limits, it will actually send the limit value.
 - **Minimum (Cooling / Dry / Auto Mode):** sets the upper limit.
 - **Maximum (Heating / Auto Mode):** sets the lower limit.

Once these limits are enabled, several objects to modify them at run time will be available. The values of this objects will be restricted to an interval which is defined by the absolute limits established by the A/C unit (10°C to 32°C).

- “[AC] Temperature Setpoint: Lower Limit”: 2-Byte object that allows changing the lower limit at run time.
- “[AC] Temperature Setpoint: Lower Limit (Status)”: 2-Byte object with the lower limit current value.
- “[AC] Temperature Setpoint: Upper Limit”: 2-Byte object that allows changing the upper limit at run time.
- “[AC] Temperature Setpoint: Upper Limit (Status)”: 2-Byte object with the upper limit current value.

Notes:

- *If [Minimum] ≥ [Maximum], limits will not be taken in account in Auto mode due to the incongruity. In this case, default values will be used.*
- *These parameters only can be set as integer values in ETS. However, at run time the associated objects allow decimal values.*

OPERATING TIME

The hours that A/C unit has been operating can be known through the 2-byte object “[AC] Operating time”. This object can be read and overwritten during run time.

Figure 1. A/C Gateway. Configuration. Operating time.

Furthermore, the available parameters in ETS are:

- **Initial Operation Time:**
 - “Keep current value”: option enabled by default, which keep the previous value.
 - “Set value”: allows establishing an initial operating time value.
- **Periodic Sending:** resending period (in hours) of operating time. If set to 0 the periodic send is disabled.

When operating time object reaches its maximum value (65535 hours), it will be send through KNX bus (in spite of the fact that the periodical sending has not been configured) and it will keep this value until the user reset it.

AUTOMATIC OFF

Figure 12: A/C Gateway. Configuration. Automatic Off.

- **Automatic Off:** enables the “[AC] Automatic Off” and the “[AC] Automatic Off (Status)” binary objects, which lets performing a temporary switch-off of

the A/C unit or reading the current status This object will be typically linked to a window sensor or a similar event trigger.

- **Automatic Off Object Polarity:** sets the polarity of the above object: “0 = Activate; 1 = Deactivate On” or “0 = Deactivate; 1 = Activate”.
- **Automatic Off Delay:** sets the time, in seconds, KLIC-LG1 waits before switching the A/C machine off. Any switch-off order received during the delay will abort the time count. This delay can be modified at runtime through the object “[AC] Automatic Off Delay”. The sending of the value “0” disables the automatic off functionality.

Note: *switch-on orders sent to the A/C unit from a wired remote control have a higher priority than the Auto Off mode.*

INITIAL CONFIGURATION



Figure 13: A/C Gateway. Configuration. Initial Configuration.

- **Initial Configuration:** allows setting the desired initial state that KLIC-LG1 will send the A/C unit after programming or restarting the device:
 - “Default”: the initial state will be the last one KLIC-LG1 is aware of.
 - “Custom”: see section 2.4.4.

SCENES



Figure 14: A/C Gateway. Configuration. Scenes.

- **Scenes:** allows setting up different scenes (up to 5), consisting each of them in a set of orders to be sent to the A/C unit upon the reception of scene trigger values through the KNX bus. See section 2.4.5.

2.4.2 FAN

The Fan function allows sending the A/C unit orders to switch the ventilation speed along the available levels. To that end, KLIC-LG1 provides a **percentage** control.

In addition, KLIC-LG1 allows activating the **automatic fan speed mode**, in case of being available in the unit, and an individual object for automatic speed control.

Referring to the user manual of the A/C unit is advisable prior to setting up these options.

ETS PARAMETRISATION

After enabling this function, the menu on the left will show a new tab named Speeds, containing the following parameters:

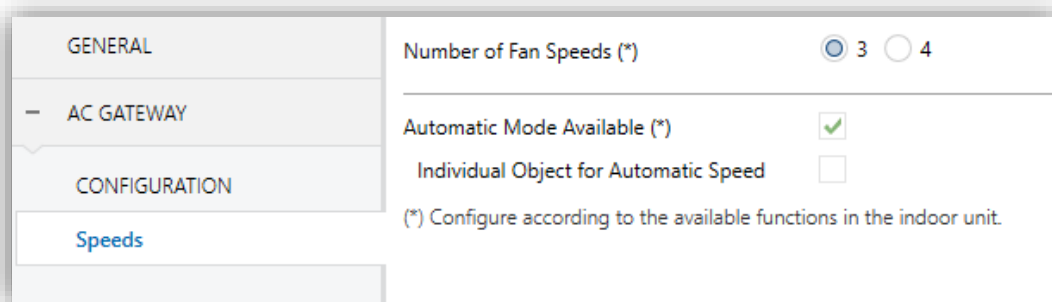

Figure 15: A/C Gateway. Speeds.

- **Number of Fan Speeds:** allows specifying the number of the fan levels distinguished by the A/C unit, which may be **3 or 4 levels**. This determines the values of the "[AC] Speed: Percentage Control" and "[AC] Speed: Percentage Control (Status)" 1-Byte objects, which allow setting and reading the fan speed, respectively. The following tables show the percentage values that correspond to each of the available fan speeds:

- "Three levels":

Control Values	Status Value	Level Sent to the Unit
1-33%	33%	1 (minimum)
34-66%	66%	2
67-100%	100%	3 (maximum)

Table 2. Fan speed (three levels).

- “Four levels”:

Control Values	Status Values	Level Sent to the Unit
1-25%	25%	1 (minimum)
26-50%	50%	2
51-75%	75%	3
76-100%	100%	4 (maximum)

Table 3. Fan speed (four levels).

- **Automatic Mode Available:** sets whether the A/C unit incorporates an automatic fan speed mode. If enabled, value “0%” of the “[AC] Speed: Percentage Control” and “[AC] Speed: Percentage Control (Status)” objects will be reserved for triggering or reporting such mode, respectively. Moreover, two more parameters will show:
 - **Individual Object for Automatic Speed:** enables the “[AC] Speed: Automatic” and “[AC] Speed: Automatic (Status)” 1-Bit objects, which will let activating/deactivating the automatic mode or reading the current status, respectively.
 - **Automatic Speed Object Polarity:** sets the polarity of the above objects: “0 = Automatic Off; 1 = Automatic On” or “0 = Automatic On; 1 = Automatic Off”.

2.4.3 FLAPS

The Flaps function allows sending the A/C unit orders to switch the position of the flaps (or vanes) that direct the air flow outwards. To that end, KLIC-LG1 provides a **percentage** control.

In addition, KLIC-LG1 allows activating the **direct positioning** of the flaps and the **swing** and **swirl functions** (so the flaps oscillate continuously for better distribution of the airflow), in case of being available in the unit.

Referring to the user manual of the A/C unit is advisable prior to setting up these options.

ETS PARAMETRISATION

After enabling this function, the menu on the left will show a new tab named Flaps, containing the following parameters:

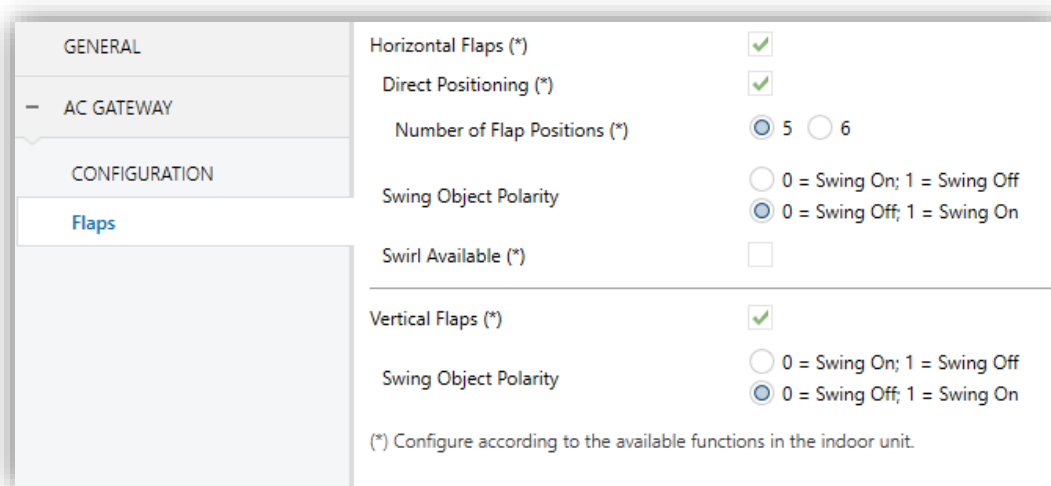

Figure 16: A/C Gateway. Flaps.

- **Horizontal Flaps:** enables the “[AC] Horizontal Flaps: Swing” and “[AC] Horizontal Flaps: Swing (Status)” 1-Bit objects, which will let activating/deactivating the swing function or reading its current status, respectively.
- **Direct Positioning:** enables the “[AC] Horizontal Flaps: Percentage Control” 1-byte object, which allow setting the position of the flaps.
- **Number of Flap Positions:** either “5” or “6”. This determines the values of the “[AC] Horizontal Flaps: Percentage Control” object. The following tables show the percentage values that correspond to each of the available positions:
 - “Five positions”:

Control Values	Status Value	Position Sent to the Unit
1-20%	20%	Position 1
21-40%	40%	Position 2
41-60%	60%	Position 3
61-80%	80%	Position 4

81-100% 100% Position 5

Table 4. Flap position (five positions).

- “Six positions”:

Control Values	Status Value	Position Sent to the Unit
1-16%	16%	Position 1
17-33%	33%	Position 2
34-50%	50%	Position 3
51-66%	66%	Position 4
67%-83%	83%	Position 5
84%-100%	100%	Position 6

Table 5. Flap position (six positions).

- **Swing Object Polarity:** sets the polarity of the enabled object: “0 = Swing Off; 1 = Swing On” or “0 = Swing On; 1 = Swing Off”.
- **Swirl available:** sets whether the A/C unit incorporates a Swirl function. If enabled, the “[AC] Horizontal Flaps: Swirl” and “[AC] Horizontal Flaps: Swirl (Status)” binary objects are incorporated into the project topology to allow activating or deactivating such mode and consulting whether it is currently active, respectively.
- **Vertical Flaps:** enables the “[AC] Vertical Flaps: Swing” and “[AC] Vertical Flaps: Swing (Status)” 1-Bit objects, which will let activating/deactivating the swing function or reading its current status, respectively.
 - **Swing Object Polarity:** sets the polarity of the enabled object: “0 = Swing Off; 1 = Swing On” or “0 = Swing On; 1 = Swing Off”.

2.4.4 INITIAL CONFIGURATION

The custom initial configuration allows setting the desired status that KLIC-LG1 will send the A/C unit after downloading or restarting the device. This status is defined in terms of on/off, mode, fan speed, flaps position and temperature setpoint.

In addition, it is possible to activate an initial sending of this status to the KNX bus.

ETS PARAMETRISATION

After selecting “Custom” for the **Initial Configuration** option under the Configuration tab (see section 2.4.1), a new tab named **Initial Configuration** is displayed with the following parameters:

GENERAL	On/Off	Last (Before Restart)
AC GATEWAY	Mode	Last (Before Restart)
CONFIGURATION	Fan Speed	Last (Before Restart)
Speeds	Horizontal Flaps	Last (Before Restart)
Flaps	Vertical Flaps	Last (Before Restart)
Initial Configuration	Setpoint	<input type="checkbox"/>
	Value	Last (Before Restart)
	Initial Sending of Status	<input type="checkbox"/>

Figure 17: Initial configuration.

- **On/Off:** “Last” (the state the machine had before the power failure), “On” or “Off”.

Note: in case of choosing “Off”, it won’t be possible to change the remaining parameters.

- **Mode:** “Last”, “Heating”, “Dry”, “Cooling”, “Fan” or “Automatic”.
- **Fan Speed:** “Last”, “Automatic” (if the automatic fan speed control is available), or any of the available fan speeds (1-4).
- **Horizontal Flaps:** “Last”, “Swing”, “Swirl” or any of the available flap positions (1-6) (depending on A/C unit functions and the established configuration).
- **Vertical Flaps:** “Last”, “Swing On” or “Swing Off” (depending on A/C unit functions and the established configuration).
- **Setpoint:** “Last” or any value between 10°C and 32°C.

Note: this initial setpoint value may be modified by the setpoint limits during runtime.

- **Initial Sending of Status:** If enabled, the status objects will be sent to the KNX bus after applying the **delay** set.

Note: even if this option is not enabled, the status objects may be sent to the KNX bus if the initial configuration differs from the current status of the A/C machine.

2.4.5 SCENES

The Scenes function allows defining a set of statuses (in terms of On/Off, mode, fan speed, etc.) that KLIC-LG1 will send to the A/C unit whenever it receives the corresponding scene values from the KNX bus.

ETS PARAMETRISATION

After enabling this function (see section 2.4.1), a new tab named Scenes will be incorporated to the tab tree. It allows setting up different scenes (up to 5), consisting each of them in a set of orders to be sent to the A/C unit upon the reception, through the KNX bus and by means of the “[AC] Scene” object, of the corresponding scene value (decreased by 1, according to the KNX standard).

For every enabled scene (**Scene *n***), the particular parameters that should be configured are:

GENERAL	Scene 1	<input checked="" type="checkbox"/>
AC GATEWAY	Scene Number	1
CONFIGURATION	On/Off	No Change
Speeds	Mode	No Change
Flaps	Fan Speed	No Change
Scenes	Horizontal Flaps	No Change
	Vertical Flaps	No Change
	Setpoint	<input type="checkbox"/>
	Value	No Change
	Scene 2	<input type="checkbox"/>

Figure 18: Scenes.

- **Scene number:** sets the scene number (1-64) that, upon reception through the “[AA] Scene” object (decreased by one), will trigger the corresponding orders, as defined next.
- **On/Off:** “No change”, “On” or “Off”.

Note: *in case of choosing “Off”, it won’t be possible to change the remaining parameters.*

- **Mode:** “No change”, “Heating”, “Dry”, “Cooling”, “Fan” or “Automatic”.
- **Fan Speed:** “No change”, “Automatic” (if available) or any of the available fan speeds (1-4).
- **Horizontal Flaps:** “Last”, “Swing”, “Swirl” or any of the available flap positions (1-6) (depending on A/C unit functions and the established configuration)..
- **Vertical Flaps:** “Last”, “Swing On” or “Swing Off” (depending on A/C unit functions and the established configuration).
- **Setpoint:** “Last” or any value between 10°C and 32°C.

Note: *this initial setpoint value may be modified by the setpoint limits during runtime.*

2.4.6 ERROR HANDLING

KLIC-LG1 is capable of managing two error types:

- **Communication (or internal) errors:** errors in the communication process between KLIC-LG1 and the A/C unit:
 - **Control error:** KLIC-LG1 is not able to establish communication with the A/C machine.
 - **No response (time out):** KLIC-LG1 received no response after sending a request to the A/C unit.
- **Errors in the A/C unit:** errors reported by the A/C unit itself. KLIC-LG1 can notify the KNX bus about the reported error code, although referring to the specific documentation of the A/C machine is advisable in order to obtain further information.

ETS PARAMETRISATION

The error handling function does not entail any parameter configuration. The following objects are available by default:

- Internal error objects:
 - “[AC] Internal Error: Control” (1-Bit object).
 - “[AC] Internal Error: Timeout” (1-Bit object).

In case any of the above errors is detected, the corresponding object will be sent (with a value of “1”) to the KNX bus. Once the error is over, it the object will be sent with a value of “0”.

- Errors in the AC machine:
 - “[AC] AC Unit Error: Active Error” (1-Bit object).
 - “[AC] AC Unit Error: Error Code” (14-Byte object).

In case the A/C unit reports an error, the former object will send a value of “1”, while the latter will report the corresponding error code. Once the error is over, the binary object will send a value of “0”. Please refer to the user manual of the A/C unit for details about the error codes.

ANNEX I. COMMUNICATION OBJECTS

- “Functional range” shows the values that, with independence of any other values permitted by the bus according to the object size, may be of any use or have a particular meaning because of the specifications or restrictions from both the KNX standard or the application program itself.

Number	Size	I/O	Flags	Data type (DPT)	Functional Range	Name	Function
1	1 Bit		CT---	DPT_Trigger	0/1	[Heartbeat] Object to Send '1'	Sending of '1' Periodically
2-33	1 Bit	I	C--W-	DPT_Bool	0/1	[LF] (1-Bit) Data Entry x	Binary Data Entry (0/1)
34- 49	1 Byte	I	C--W-	DPT_Value_1_Ucount	0 - 255	[LF] (1-Byte) Data Entry x	1-Byte Data Entry (0-255)
50-65	2 Bytes	I	C--W-	DPT_Value_2_Ucount	0 - 65535	[LF] (2-Byte) Data Entry x	2-Byte Data Entry
				DPT_Value_2_Count	-32768 - 32767		
				DPT_Value_Temp	-273,00 - 670760,00		
66- 73	4 Bytes	I	C--W-	DPT_Value_4_Count	-2147483648 - 214748347	[LF] (4-Byte) Data Entry x	4-Byte Data Entry
74- 83	1 Bit	O	CTR--	DPT_Bool	0/1	[LF] Function x - Result	(1-Bit) Boolean
	1 Byte	O	CTR--	DPT_Value_1_Ucount	0 - 255	[LF] Function x - Result	(1-Byte) Unsigned
	2 Bytes	O	CTR--	DPT_Value_2_Ucount	0 - 65535	[LF] Function x - Result	(2-Byte) Unsigned
	4 Bytes	O	CTR--	DPT_Value_4_Count		[LF] Function x - Result	(4-Byte) Signed
	1 Byte	O	CTR--	DPT_Scaling	0% - 100%	[LF] Function x - Result	(1-Byte) Percentage
	2 Bytes	O	CTR--	DPT_Value_2_Count	-32768 - 32767	[LF] Function x - Result	(2-Byte) Signed
	2 Bytes	O	CTR--	DPT_Value_Temp	-273.00 - 670760.00	[LF] Function x - Result	(2-Byte) Float
84, 90, 96	1 Bit	I	C--W-	DPT_Enable	0/1	[Ix] Input Lock	0 = Unlock; 1 = Lock
85, 91, 97	1 Bit		CT---	DPT_Switch	0/1	[Ix] [Short Press] 0	Sending of 0
	1 Bit		CT---	DPT_Switch	0/1	[Ix] [Short Press] 1	Sending of 1
	1 Bit	I	CT-W-	DPT_Switch	0/1	[Ix] [Short Press] 0/1 Switching	Switching 0/1
	1 Bit		CT---	DPT_UpDown	0/1	[Ix] [Short Press] Move Up Shutter	Sending of 0 (Up)
	1 Bit		CT---	DPT_UpDown	0/1	[Ix] [Short Press] Move Down Shutter	Sending of 1 (Down)
	1 Bit		CT---	DPT_UpDown	0/1	[Ix] [Short Press] Move Up/Down Shutter	Switching 0/1 (Up/Down)
	1 Bit		CT---	DPT_Step	0/1	[Ix] [Short Press] Stop/Step Up Shutter	Sending of 0 (Stop/Step Up)
	1 Bit		CT---	DPT_Step	0/1	[Ix] [Short Press] Stop/Step Down Shutter	Sending of 1 (Stop/Step Down)
	1 Bit		CT---	DPT_Step	0/1	[Ix] [Short Press] Stop/Step Shutter (Switched)	Switching of 0/1 (Stop/Step Up/Down)
	4 Bit		CT---	DPT_Control_Dimming	0x0 (Stop) 0x1 (Dec. by 100%)	[Ix] [Short Press] Brighter	Increase Brightness

				0x2 (Dec. by 50%) 0x3 (Dec. by 25%) 0x4 (Dec. by 12%) 0x5 (Dec. by 6%) 0x6 (Dec. by 3%) 0x7 (Dec. by 1%) 0x8 (Stop) 0x9 (Inc. by 100%) 0xA (Inc. by 50%) 0xB (Inc. by 25%) 0xC (Inc. by 12%) 0xD (Inc. by 6%) 0xE (Inc. by 3%) 0xF (Inc. by 1%)			
	4 Bit		CT---	DPT_Control_Dimming	0x0 (Stop) 0x1 (Dec. by 100%) ... 0x8 (Stop) 0x9 (Inc. by 100%) ... 0xF (Inc. by 1%)	[Ix] [Short Press] Darker	Decrease Brightness
	4 Bit		CT---	DPT_Control_Dimming	0x0 (Stop) 0x1 (Dec. by 100%) ... 0x8 (Stop) 0x9 (Inc. by 100%) ... 0xF (Inc. by 1%)	[Ix] [Short Press] Brighter/Darker	Switch Bright/Dark
	1 Bit		CT---	DPT_Switch	0/1	[Ix] [Short Press] Light On	Sending of 1 (On)
	1 Bit		CT---	DPT_Switch	0/1	[Ix] [Short Press] Light Off	Sending of 0 (Off)
	1 Bit	I	CT-W-	DPT_Switch	0/1	[Ix] [Short Press] Light On/Off	Switching 0/1
	1 Byte		CT---	DPT_SceneControl	0-63; 128-191	[Ix] [Short Press] Run Scene	Sending of 0 - 63
	1 Byte		CT---	DPT_SceneControl	0-63; 128-191	[Ix] [Short Press] Save Scene	Sending of 128 - 191
	1 Bit	I/O	CTRW-	DPT_Switch	0/1	[Ix] [Switch/Sensor] Edge	Sending of 0 or 1
	1 Byte		CT---	DPT_Value_1_Ucount	0 - 255	[Ix] [Short Press] Constant Value (Integer)	0 - 255
	1 Byte		CT---	DPT_Scaling	0% - 100%	[Ix] [Short Press] Constant Value (Percentage)	0% - 100%
	2 Bytes		CT---	DPT_Value_2_Ucount	0 - 65535	[Ix] [Short Press] Constant Value (Integer)	0 - 65535
	2 Bytes		CT---	9.xxx	-671088.64 - 670760.96	[Ix] [Short Press] Constant Value (Float)	Float Value
86, 92, 98	1 Byte	I	C--W-	DPT_Scaling	0% - 100%	[Ix] [Short Press] Shutter Status (Input)	0% = Top; 100% = Bottom
	1 Byte	I	C--W-	DPT_Scaling	0% - 100%	[Ix] [Short Press] Dimming Status (Input)	0% - 100%
87, 93, 99	1 Bit		CT---	DPT_Switch	0/1	[Ix] [Long Press] 0	Sending of 0
	1 Bit		CT---	DPT_Switch	0/1	[Ix] [Long Press] 1	Sending of 1
	1 Bit	I	CT-W-	DPT_Switch	0/1	[Ix] [Long Press] 0/1 Switching	Switching 0/1
	1 Bit		CT---	DPT_UpDown	0/1	[Ix] [Long Press] Move Up Shutter	Sending of 0 (Up)

	1 Bit		CT---	DPT_UpDown	0/1	[Ix] [Long Press] Move Down Shutter	Sending of 1 (Down)
	1 Bit		CT---	DPT_UpDown	0/1	[Ix] [Long Press] Move Up/Down Shutter	Switching 0/1 (Up/Down)
	1 Bit		CT---	DPT_Step	0/1	[Ix] [Long Press] Stop/Step Up Shutter	Sending of 0 (Stop/Step Up)
	1 Bit		CT---	DPT_Step	0/1	[Ix] [Long Press] Stop/Step Down Shutter	Sending of 1 (Stop/Step Down)
	1 Bit		CT---	DPT_Step	0/1	[Ix] [Long Press] Stop/Step Shutter (Switched)	Switching of 0/1 (Stop/Step Up/Down)
	4 Bit		CT---	DPT_Control_Dimming	0x0 (Stop) 0x1 (Dec. by 100%) 0x2 (Dec. by 50%) ... 0x8 (Stop) 0x9 (Inc. by 100%) ... 0xF (Inc. by 1%)	[Ix] [Long Press] Brighter	Long Pr. -> Brighter; Release -> Stop
	4 Bit		CT---	DPT_Control_Dimming	0x0 (Stop) 0x1 (Dec. by 100%) ... 0x8 (Stop) 0x9 (Inc. by 100%) ... 0xF (Inc. by 1%)	[Ix] [Long Press] Darker	Long Pr. -> Darker; Release -> Stop
	4 Bit		CT---	DPT_Control_Dimming	0x0 (Stop) 0x1 (Dec. by 100%) ... 0x8 (Stop) 0x9 (Inc. by 100%) ... 0xF (Inc. by 1%)	[Ix] [Long Press] Brighter/Darker	Long Pr. -> Brighter/Darker; Release -> Stop
	1 Bit		CT---	DPT_Switch	0/1	[Ix] [Long Press] Light On	Sending of 1 (On)
	1 Bit		CT---	DPT_Switch	0/1	[Ix] [Long Press] Light Off	Sending of 0 (Off)
	1 Bit	I	CT-W-	DPT_Switch	0/1	[Ix] [Long Press] Light On/Off	Switching 0/1
	1 Byte		CT---	DPT_SceneControl	0-63; 128-191	[Ix] [Long Press] Run Scene	Sending of 0 - 63
	1 Byte		CT---	DPT_SceneControl	0-63; 128-191	[Ix] [Long Press] Save Scene	Sending of 128 - 191
	1 Bit	O	CTR--	DPT_Alarm	0/1	[Ix] [Switch/Sensor] Alarm: Breakdown or Sabotage	1 = Alarm; 0 = No Alarm
	2 Bytes		CT---	9.xxx	-671088.64 - 670760.96	[Ix] [Long Press] Constant Value (Float)	Float Value
	2 Bytes		CT---	DPT_Value_2_Ucount	0 - 65535	[Ix] [Long Press] Constant Value (Integer)	0 - 65535
	1 Byte		CT---	DPT_Scaling	0% - 100%	[Ix] [Long Press] Constant Value (Percentage)	0% - 100%
	1 Byte		CT---	DPT_Value_1_Ucount	0 - 255	[Ix] [Long Press] Constant Value (Integer)	0 - 255
88, 94, 100	1 Bit		CT---	DPT_Trigger	0/1	[Ix] [Long Press/Release] Stop Shutter	Release -> Stop Shutter
89, 95, 101	1 Byte	I	C--W-	DPT_Scaling	0% - 100%	[Ix] [Long Press] Dimming Status (Input)	0% - 100%
	1 Byte	I	C--W-	DPT_Scaling	0% - 100%	[Ix] [Long Press] Shutter Status (Input)	0% = Top; 100% = Bottom
102	1 Byte	I	C--W-	DPT_SceneControl	0-63; 128-191	[Motion Detector] Scene Input	Scene Value
103	1 Byte		CT---	DPT_SceneControl	0-63; 128-191	[Motion Detector] Scene Output	Scene Value

104, 133, 162	1 Byte	O	CTR--	DPT_Scaling	0% - 100%	[Ix] Luminosity	0-100%
105, 134, 163	1 Bit	O	CTR--	DPT_Alarm	0/1	[Ix] Open Circuit Error	0 = No Error; 1 = Open Circuit Error
106, 135, 164	1 Bit	O	CTR--	DPT_Alarm	0/1	[Ix] Short Circuit Error	0 = No Error; 1 = Short Circuit Error
107, 136, 165	1 Byte	O	CTR--	DPT_Scaling	0% - 100%	[Ix] Presence State (Scaling)	0-100%
108, 137, 166	1 Byte	O	CTR--	DPT_HVACMode	1=Comfort 2=Standby 3=Economy 4=Building Protection	[Ix] Presence State (HVAC)	Auto, Comfort, Standby, Economy, Building Protection
109, 138, 167	1 Bit	O	CTR--	DPT_Occupancy	0/1	[Ix] Presence State (Binary)	Binary Value
	1 Bit	O	CTR--	DPT_Ack	0/1	[Ix] Presence: Slave Output	1 = Motion Detected
110, 139, 168	1 Bit	I	C--W-	DPT_Window_Door	0/1	[Ix] Presence Trigger	Binary Value to Trigger the Presence Detection
111, 140, 169	1 Bit	I	C--W-	DPT_Ack	0/1	[Ix] Presence: Slave Input	0 = Nothing; 1 = Detection from slave device
112, 141, 170	2 Bytes	I	C--W-	DPT_TimePeriodSec	0 - 65535	[Ix] Presence: Waiting Time	0-65535 s.
113, 142, 171	2 Bytes	I	C--W-	DPT_TimePeriodSec	0 - 65535	[Ix] Presence: Listening Time	1-65535 s.
114, 143, 172	1 Bit	I	C--W-	DPT_Enable	0/1	[Ix] Presence: Enable	According to parameters
115, 144, 173	1 Bit	I	C--W-	DPT_Switch	0/1	[Ix] Presence: Day/Night	According to parameters
116, 145, 174	1 Bit	O	CTR--	DPT_Occupancy	0/1	[Ix] Presence: Occupancy State	0 = Not Occupied; 1 = Occupied
117, 146, 175	1 Bit	I	C--W-	DPT_Ack	0/1	[Ix] External Motion Detection	0 = Nothing; 1 = Motion detected by an external sensor
118, 123, 128, 147, 152, 157, 176, 181, 186	1 Byte	O	CTR--	DPT_Scaling	0% - 100%	[Ix] [Cx] Detection State (Scaling)	0-100%
119, 124, 129, 148, 153, 158, 177, 182, 187	1 Byte	O	CTR--	DPT_HVACMode	1=Comfort 2=Standby 3=Economy 4=Building Protection	[Ix] [Cx] Detection State (HVAC)	Auto, Comfort, Standby, Economy, Building Protection
120, 125, 130, 149, 154, 159, 178, 183, 188	1 Bit	O	CTR--	DPT_Switch	0/1	[Ix] [Cx] Detection State (Binary)	Binary Value
121, 126, 131, 150, 155, 160, 179, 184, 189	1 Bit	I	C--W-	DPT_Enable	0/1	[Ix] [Cx] Enable Channel	According to parameters
122, 127, 132, 151, 156, 161, 180, 185, 190	1 Bit	I	C--W-	DPT_Switch	0/1	[Ix] [Cx] Force State	0 = No Detection; 1 = Detection
191, 195, 199	2 Bytes	O	CTR--	DPT_Value_Temp	-273.00 - 670760.00	[Ix] Current Temperature	Temperature sensor value
192, 196, 200	1 Bit	O	CTR--	DPT_Alarm	0/1	[Ix] Overcooling	0 = No Alarm; 1 = Alarm
193, 197, 201	1 Bit	O	CTR--	DPT_Alarm	0/1	[Ix] Overheating	0 = No Alarm; 1 = Alarm
194, 198, 202	1 Bit	O	CTR--	DPT_Alarm	0/1	[Ix] Probe Error	0 = No Alarm; 1 = Alarm
203	1 Byte	I/O	CTR W U	DPT_SceneControl	0-63; 128-191	[AC] Scene	0 - 63 (Execute 1 - 64); 128 - 129 (Save 1 - 64)

204	1 Byte	I	C - - W -	DPT_HVACContrMode	0 = Auto 1 = Heat 3 = Cool 9 = Fan 14 = Dry	[AC] Mode	0 = Automatic; 1 = Heating; 3 = Cooling; 9 = Fan; 14 = Dry
	1 Byte	I	C - - W -	DPT_HVACContrMode	0 = Auto 1 = Heat 3 = Cool 9 = Fan 14 = Dry	[AC] Mode	3 = Cooling; 9 = Fan; 14 = Dry
205	1 Byte	O	CTR - -	DPT_HVACContrMode	0 = Auto 1 = Heat 3 = Cool 9 = Fan 14 = Dry	[AC] Mode (Status)	0 = Automatic; 1 = Heating; 3 = Cooling; 9 = Fan; 14 = Dry
	1 Byte	O	CTR - -	DPT_HVACContrMode	0 = Auto 1 = Heat 3 = Cool 9 = Fan 14 = Dry	[AC] Mode (Status)	3 = Cooling; 9 = Fan; 14 = Dry
206	1 Bit	I	C - - W -	DPT_Heat_Cool	0/1	[AC] Simplified Mode	0 = Cooling; 1 = Heating
207	1 Bit	O	CTR - -	DPT_Heat_Cool	0/1	[AC] Simplified Mode (Status)	0 = Cooling; 1 = Heating
208	1 Bit	I	C - - W -	DPT_Switch	0/1	[AC] On/Off	0 = Off; 1 = On
209	1 Bit	O	CTR - -	DPT_Switch	0/1	[AC] On/Off (Status)	0 = Off; 1 = On
210	1 Bit	O	CTR - -	DPT_Bool	0/1	[AC] Internal Error: Control	Unable to Control the AC
211	1 Bit	O	CTR - -	DPT_Bool	0/1	[AC] Internal Error: Timeout	No Acknowledgement Received from AC
212	1 Bit	O	CTR - -	DPT_Bool	0/1	[AC] AC Unit Error: Active Error	AC Unit Error
213	14 Bytes	O	CTR - -	DPT_String_ASCII	0/1	[AC] AC Unit Error: Error Code	See AC Unit Manual
214	1 Byte	I	C - - W -	DPT_Scaling	0% - 100%	[AC] Speed: Percentage Control	0 % = Automatic; [0.4...25.1] % = S1; [25.5...50.2] % = S2; [50.6...75.3] % = S3; [75.7...100] % = S4
	1 Byte	I	C - - W -	DPT_Scaling	0% - 100%	[AC] Speed: Percentage Control	0 % = Automatic; [0.4...33.3] % = S1; [33.7...66.7] % = S2; [67.0...100] % = S3
	1 Byte	I	C - - W -	DPT_Scaling	0% - 100%	[AC] Speed: Percentage Control	[0.4...25.1] % = S1; [25.5...50.2] % = S2; [50.6...75.3] % = S3; [75.7...100] % = S4
	1 Byte	I	C - - W -	DPT_Scaling	0% - 100%	[AC] Speed: Percentage Control	[0.4...33.3] % = S1; [33.7...66.7] % = S2; [67.0...100] % = S3
215	1 Byte	O	CTR - -	DPT_Scaling	0% - 100%	[AC] Speed: Percentage Control (Status)	Automatic = 0 %; S1 = 25 %; S2 = 50 %; S3 = 75 %; S4 = 100 %
	1 Byte	O	CTR - -	DPT_Scaling	0% - 100%	[AC] Speed: Percentage Control (Status)	Automatic = 0 %; S1 = 33.3 %; S2 = 66.7 %; S3 = 100 %
	1 Byte	O	CTR - -	DPT_Scaling	0% - 100%	[AC] Speed: Percentage Control (Status)	S1 = 25 %; S2 = 50 %; S3 = 75 %; S4 = 100 %

	1 Byte	O	CTR--	DPT_Scaling	0% - 100%	[AC] Speed: Percentage Control (Status)	S1 = 33.3 %; S2 = 66.7 %; S3 = 100 %
216	1 Bit	I	C--W-	DPT_Switch	0/1	[AC] Horizontal Flaps: Swing	0 = Swing On; 1 = Swing Off
	1 Bit	I	C--W-	DPT_Switch	0/1	[AC] Horizontal Flaps: Swing	0 = Swing Off; 1 = Swing On
217	1 Bit	O	CTR--	DPT_Switch	0/1	[AC] Horizontal Flaps: Swing (Status)	0 = Swing On; 1 = Swing Off
	1 Bit	O	CTR--	DPT_Switch	0/1	[AC] Horizontal Flaps: Swing (Status)	0 = Swing Off; 1 = Swing On
218	1 Bit	I	C--W-	DPT_Switch	0/1	[AC] Horizontal Flaps: Swirl	0 = Swirl Off; 1 = Swirl On
219	1 Bit	O	CTR--	DPT_Switch	0/1	[AC] Horizontal Flaps: Swirl (Status)	0 = Swirl Off; 1 = Swirl On
220	1 Bit	I	C--W-	DPT_Switch	0/1	[AC] Vertical Flaps: Swing	0 = Swing On; 1 = Swing Off
	1 Bit	I	C--W-	DPT_Switch	0/1	[AC] Vertical Flaps: Swing	0 = Swing Off; 1 = Swing On
221	1 Bit	O	CTR--	DPT_Switch	0/1	[AC] Vertical Flaps: Swing (Status)	0 = Swing On; 1 = Swing Off
	1 Bit	O	CTR--	DPT_Switch	0/1	[AC] Vertical Flaps: Swing (Status)	0 = Swing Off; 1 = Swing On
222	1 Byte	I	C--W-	DPT_Scaling	0% - 100%	[AC] Horizontal Flaps: Percentage Control	0 % = Swing; [0.4...20] % = P1; [20.4...40] % = P2; [40.4...60] % = P3; [60.4...80] % = P4; [80.4...100] % = P5
	1 Byte	I	C--W-	DPT_Scaling	0% - 100%	[AC] Horizontal Flaps: Percentage Control	0 % = Swing; [0.4...16.7] % = P1; [17.0...33.3] % = P2; [33.7...50.2] % = P3; [50.6...66.7] % = P4; [67.0...83.3] % = P5; [83.7...100] % = P6
223	1 Bit	I	C--W-	DPT_Switch	0/1	[AC] Speed: Automatic	0 = Automatic Off (Speed 1); 1 = Automatic On
	1 Bit	I	C--W-	DPT_Switch	0/1	[AC] Speed: Automatic	0 = Automatic On; 1 = Automatic Off (Speed 1)
224	1 Bit	O	CTR--	DPT_Switch	0/1	[AC] Speed: Automatic (Status)	0 = Automatic On; 1 = Automatic Off
	1 Bit	O	CTR--	DPT_Switch	0/1	[AC] Speed: Automatic (Status)	0 = Automatic Off; 1 = Automatic On
225	1 Bit	I	C--W-	DPT_Switch	0/1	[AC] Automatic Off	0 = Deactivate; 1 = Activate
	1 Bit	I	C--W-	DPT_Switch	0/1	[AC] Automatic Off	0 = Activate; 1 = Deactivate
226	1 Bit	O	CTR--	DPT_Switch	0/1	[AC] Automatic Off (Status)	0 = Deactivated; 1 = Activated
	1 Bit	O	CTR--	DPT_Switch	0/1	[AC] Automatic Off (Status)	0 = Activate; 1 = Deactivate
227	2 Bytes	I	C--W-	DPT_TimePeriodSec		[AC] Automatic Off Delay	[0...3600] s (0 = Disabled)
228	2 Bytes	I	C--W-	DPT_Value_Temp	-273.00 - 670760.00	[AC] Temperature Setpoint	[10...32] °C
229	2 Bytes	O	CTR--	DPT_Value_Temp	-273.00 - 670760.00	[AC] Temperature Setpoint (Status)	[10...32] °C
230	2 Bytes	I	C--W-	DPT_Value_Temp	-273.00 - 670760.00	[AC] Temperature Setpoint: Lower Limit	[10...32] °C
231	2 Bytes	O	CTR--	DPT_Value_Temp	-273.00 - 670760.00	[AC] Temperature Setpoint: Lower Limit (Status)	[10...32] °C
232	2 Bytes	I	C--W-	DPT_Value_Temp	-273.00 - 670760.00	[AC] Temperature Setpoint: Upper Limit	[10...32] °C
233	2 Bytes	O	CTR--	DPT_Value_Temp	-273.00 - 670760.00	[AC] Temperature Setpoint: Upper Limit (Status)	[10...32] °C
234	2 Bytes	I/O	CTRW-	DPT_TimePeriodHrs	0/1	[AC] Operating Time	Time in Hours
235	2 Bytes	I	C--W-	DPT_Value_Temp	-273.00 - 670760.00	[AC] External Reference Temperature	[10...41.5] °C
236	2 Bytes	O	CTR--	DPT_Value_Temp	-273.00 - 670760.00	[AC] Reference Temperature (Status)	Effective Control Temperature (°C)

Join and send us your inquiries
about Zennio devices:

<http://support.zennio.com>

Zennio Avance y Tecnología S.L.

C/ Río Jarama, 132. Nave P-8.11
45007 Toledo (Spain).

Tel. +34 925 232 002.

www.zennio.com
info@zennio.com



RoHS