



Z50 / Z70 v2 / Z100

Full Color Capacitive Touch Panel with 5"/ 7"/ 10" display

ZVIZ50 / ZVIZ70V2 / ZVIZ100

Application Program Version: [4.0]
User Manual Version: [4.0]_a

CONTENTS

Contents	2
Document updates.....	6
1 Introduction	8
1.1 Z50 / Z70 v2 / Z100.....	8
1.2 Functionality.....	11
1.3 Initialisation and Start-up.....	12
1.3.1 EULA	13
1.3.2 Firmware update without application program.....	13
2 Configuration.....	14
2.1 General	14
2.1.1 Web Server	14
2.1.2 Configuration.....	15
2.1.3 Time Configuration.....	22
2.1.4 Locale	24
2.1.5 Backlight	27
2.1.6 Security.....	27
2.1.7 Schedulers	30
2.1.8 Energy Monitor	33
2.1.8.1 Individual consumption n.....	38
2.1.9 Screensaver	38
2.1.10 Internal Temperature Sensor	40
2.1.11 Ambient Luminosity Sensor	40
2.1.12 Touch Locking.....	41
2.1.13 Sounds.....	42
2.1.14 Update Setting	43
2.1.14.1 Firmware Update.....	44
2.1.14.2 Licence Setup.....	45
2.1.14.3 Import and export translations	46
2.1.14.4 Custom Icons	47
2.1.15 IP Configuration.....	49

2.1.16 VoIP Calls (License required)	52
2.1.16.1 Video Intercom (License required)	54
2.1.16.1.1 Outdoor Unit N	57
2.1.16.1.2 General Outdoor Unit	62
2.1.16.2 Internal Call (License required)	63
2.1.16.2.1 Contact n	65
2.1.17 IP Cameras	66
2.1.17.1 Camera N	67
2.1.18 Avanced	69
2.1.18.1 Cleaning Function	70
2.1.18.2 Pop-ups	71
2.1.18.2.1 Pop-Up n	72
2.1.18.3 Welcome back object	73
2.2 Display	76
2.2.1 Pages	76
2.2.1.1 Menu	78
2.2.1.2 Configuration Page	79
2.2.1.2.1 Device	83
2.2.1.2.2 Profile	85
2.2.1.2.3 VoIP Calls (License Required)	86
2.2.1.3 Page <i>n</i>	88
2.2.2 Controls	90
2.2.2.1 Control <i>i</i>	91
2.2.2.1.1 INDICATORS	94
2.2.2.1.1.1 Binary	94
2.2.2.1.1.2 Enumeration	94
2.2.2.1.1.3 Numerical Indicators	95
2.2.2.1.1.4 Text	97
2.2.2.1.2 1-BUTTON CONTROL	97
2.2.2.1.2.1 Switch	97
2.2.2.1.2.2 Two Objects (Short Press/Long Press)	98
2.2.2.1.2.3 Hold & Release	99
2.2.2.1.2.4 Scene	99
2.2.2.1.2.5 Constant Numerical Controls	100

2.2.2.1.2.6	Room State.....	101
2.2.2.1.2.7	Enumeration.....	102
2.2.2.1.3	2-BUTTON CONTROL.....	103
2.2.2.1.3.1	Switch.....	103
2.2.2.1.3.2	Switch + Indicator.....	103
2.2.2.1.3.3	Two Objects (Short Press/Long Press)	105
2.2.2.1.3.4	Numerical Controls	106
2.2.2.1.3.5	Enumeration.....	107
2.2.2.1.3.6	Two Scene	108
2.2.2.1.3.7	Shutter	108
2.2.2.1.3.8	Dimmer	110
2.2.2.1.3.9	Room State.....	112
2.2.2.1.4	CLIMATE CONTROL	113
2.2.2.1.4.1	Temperature Setpoint.....	113
2.2.2.1.4.2	Mode	115
2.2.2.1.4.3	Fan Control.....	117
2.2.2.1.4.4	Special Mode.....	120
2.2.2.1.5	OTHER	121
2.2.2.1.5.1	RGB Control.....	121
2.2.2.1.5.2	RGBW Control	123
2.2.2.1.5.3	Page Direct Link.....	124
2.2.2.1.5.4	Alarm	124
2.2.2.1.5.5	Video Intercom.....	126
2.2.2.1.5.6	Internal Call	127
2.2.2.1.5.7	Chronothermostat	129
2.2.2.1.5.8	Scheduler	130
2.2.2.1.5.9	Macro	131
2.2.2.1.5.10	Timer	134
2.2.2.1.5.11	Energy Monitor	136
2.2.2.1.5.12	IP Camera	137
2.2.2.1.5.13	Keypad.....	138
2.3	Inputs.....	139
2.3.1	Binary Input.....	139
2.3.2	Temperature Probe.....	139
2.3.3	Motion Detector.....	139

2.4 Thermostat n 139

ANNEX I. Video Intercom Operation 140

ANNEX II. Internal Call Operation..... 145

ANNEX III. Remote Control via IP 150

ANNEX IV. Graphs..... 153

ANNEX V. Energy monitor configuration 157

ANNEX VI. Communication Objects 159

DOCUMENT UPDATES

Version	Changes	Page(s)
[4.0]_a	<ul style="list-style-type: none"> • Added support for Akuvox video intercoms • Slider controls • New RGB panel • Numeric keypad. • Sunrise/sunset functionality • Firmware update without application program 	-
[3.7]_b	<ul style="list-style-type: none"> • Reference to new video intercom with predefined profiles configuration guide 	-
[3.7]_a	<ul style="list-style-type: none"> • Video intercom compatible • Energy monitor • IP cameras 	-
[3.5]_a	<p>Changes in the application program:</p> <ul style="list-style-type: none"> • New control: timer • Graphs functionality is added • RGBW control with independent objects 	-
[3.4]_a	<p>Changes in the application program:</p> <ul style="list-style-type: none"> • New control: Macros • Rename of the control Timer to Scheduler • Optimisation of Temp probe module 	-
[3.3]_a	<p>Changes in the application program:</p> <ul style="list-style-type: none"> • New monochromatic icons. • Schedulers functionality is added • New IP address management • The number of configurable controls has been increased to 180. • Shutter control: New object for precise control. Only used by schedulers. 	-

	<ul style="list-style-type: none"> • Dimmer control: New object for precise control. Only used by schedulers. • The chronothermostat enable control and its status indicator are unified. • Optimisation of Thermostat module. 	
[3.1]_a	<p>Changes in the application program:</p> <ul style="list-style-type: none"> • New parameter to enable/disable temperature probe. • Screensaver • Automatic Page Shaping • The "title" field of the controls is added to the prefix of their communication objects. • New 4-bytes numerical indicators and text indicator. • Chronothermostat. 	-
[3.0]_a	<p>Changes in the application program:</p> <ul style="list-style-type: none"> • Date/time synchronisation via NTP • Remote control of the device 	-

1 INTRODUCTION

1.1 Z50 / Z70 V2 / Z100

Z50, Z70 v2 and **Z100** are the easily and intuitively controllable high-performance **colour touch screens** from Zennio. The built-in features and functions make them the ideal solution for integral room control in hotels, offices or any other environments where controlling climate systems, lighting systems, shutters, scenes, etc. is required.

The most outstanding features of these screens are:

- **5-inch, 7-inch** and **10-inch** backlit **capacitive** touch panel, with 16 million colour LCD Display and screen resolution of 480 x 854 pixels (Z50) and 1280 x 800 pixels (Z70 v2 and Z100).
- Multiple **direct-action functions**, fully customisable.
- Control distribution across up to **12 customisable pages + 1 configuration page**.
- Possibility to parameterise **boxes of different sizes**.
- **Customised icons**.
- Full **climate** management.
- **Scene** control.
- **Alarm** control.
- **Light/Dark** theme.
- **Screensaver**.
- **Chronothermostat**.
- **Direct links** to other pages.
- **Locale and language** configuration.
- **2 independent thermostats**.

- Built-in **temperature** sensor
- Ambient **luminosity** sensor for brightness automatic adjustment.
- **Proximity** sensor for quick start.
- **Buzzer** for an audible acknowledgement of user actions (with the possibility of disabling it either by parameter or by object).
- Possibility of **locking / unlocking the touch panel** through binary orders or scenes, and setting a timed/automatic locking of the device (cleaning function).
- **Pop-ups and Welcome Back object** (binary or scene).
- **Celsius and Fahrenheit scales** for the on-screen temperature indicators, being possible to select them in parameters or through communication object.
- 4 customisable **analogue-digital inputs** (2 in the case of Z50).
- **Heartbeat** or periodic “still-alive” notification.
- **Elegant** design, available in various **colours**.
- Possibility of **scheduling** actions.
- **Macros**.
- **Graphs** associated with controls.
- **Energy monitor**.
- **IP cameras**.

There are also additional functionalities that require the use of a license in order to operate:

- **Video Intercom** compatible with **GetFace IP and others video intercoms**.
- **Internal Calls between** different **Z50, Z70 v2 or Z100** (also compatible with Z41 COM).
- **Remote control** from a mobile device with the possibility of administrator pairing.
- **Voice Control**.

The following table lists the main features and functionalities of the three touch screens:

	Z50	Z70 v2	Z100
Display size	5"	7"	10"
Display resolution	480x854 px	1280x800 px	1280x800 px
Menu grid	4x3	3x4	3x4
Page grid	4x2	3x4	3x4 o 4x5
Maximum number of normal pages	12	12	12
Maximum controls per page	8	12	20
Thermostats	2	2	2
Screensaver	✓	✓	✓
Multilanguage	✓	✓	✓
Custom icons	✓	✓	✓
Technical alarms	✓	✓	✓
Timers	✓	✓	✓
Internal Temperature Probe	✓	✓	-
Proximity sensor	✓	✓	✓
Luminosity sensor for brightness automatic adjustment	✓	✓	✓
Number of analogue-digital inputs	2	4	4
Remote control (Ethernet)	Under license	Under license	Under license
Video intercom and internal calls	Under license	Under license	Under license
Voice control	Under license (*)	Under license (*)	Under license (*)

(*) Remote control license required.

Table 1. Z50, Z70 v2 and Z100 features and functionalities.

1.2 FUNCTIONALITY

Screens application program feature the following functions:

- **12 General-Purpose Pages, with up to 12 Fully-Customisable Boxes each,** which the integrator may configure as indicators or controls.

- **Indicators:**

- Binary.
- Enumeration.
- Integer.
- Percentage.
- Float.
- Temperature.
- Cost.
- Text.

- **1-Button Controls:**

- Switch.
- Two Object (Short Press/Long Press).
- Hold & Release.
- Enumeration.
- Scene.
- Constant (Counter / Scaling / Float).
- Room State.

- **2-Button Controls:**

- Switch.
- Switch + Indicator (Counter / Scaling / Float / Temperature)
- Two Object (Short Press/Long Press).
- Counter.
- Scaling.
- Float.
- Enumeration.
- Two Scenes.
- Shutter.
- Dimmer.
- Room State.

- **Climate Specific Controls:**

- Temperature Setpoint control.
- Mode.
- Special modes.
- Fan.

➤ **Other Controls:**

- RGB Control.
- RGBW Control.
- Page Direct Link.
- Chronothermostat.
- Macro.
- Energy monitor.
- Keypad
- Alarm.
- Video Intercom (License required).
- Internal Calls (License required).
- Scheduler.
- Timer
- IP Cameras

- **1 Configuration Page** (optional), which contains the time/date settings, the calibration of the built-in temperature probe, and the brightness and doorbell volume and tone adjustment, among others.

1.3 INITIALISATION AND START-UP

Z50 / Z70 v2 / Z100 incorporate **two separate microcontrollers**, one of which focuses on interfacing with the KNX bus and on running the application program itself, while the second one is dedicated to running the firmware that implements the operating system and the management of the peripherals.

Therefore, the start-up or upgrade of these devices may consist in two phases:

- Downloading the **application program** (from ETS),

Note: *although the device will not turn functional until it is powered with the external supply, the KNX bus power should be enough to perform downloads from ETS (application program, group addresses, etc.).*

- Downloading the **firmware**. Two alternative methods are available:
 - By connecting a flash memory USB drive through the male Micro-USB (or Mini-USB, depending on the device) to female USB adapter.
 - Through the network from a PC running the Windows operating system, by means of the Ethernet adapter bundled with the original packaging of the device.

For further information about the firmware updating process see section 2.1.14.

For detailed information about the technical features of Z50 / Z70 v2 / Z100, as well as on security and installation procedures, please refer to the device **Datasheet**, bundled within the device packaging and also available at www.zennio.com.

1.3.1 EULA

After the first start-up of the device, a dialog with the text EULA (End User License Agreement) will be displayed.

The legal conditions of use described in EULA must be accepted by the end user before using the screen, so during the installation must be postponed. Once postponed, the EULA dialog will be displayed again after two hours or after a power failure.

As long as the EULA is not accepted or postponed, screen navigation is not allowed.

If the terms of use change, a dialog with the new text EULA to be accepted will be displayed on the screen.

1.3.2 FIRMWARE UPDATE WITHOUT APPLICATION PROGRAM

From version 4.0.0 onwards, a firmware download is possible without also downloading the application program (version 3.7.0 is the minimum version of the application program that allows firmware compatibility). This update makes it possible to easily install improvements to the device.

Notes:

- *To install new functionalities that depend on new parameters, it is necessary to download the application program.*
- *This functionality is only valid for updating to higher versions, never for downgrading to lower firmware versions. In the latter case it will be necessary to install the application program version as well.*

2 CONFIGURATION

After importing the corresponding database in ETS and adding the device into the topology of the desired project, the configuration process begins by entering the Parameters tab of the device.

2.1 GENERAL

This tab is divided into multiple screens, all of which contain a set of global parameters regarding the general functionality of the device, and therefore not specifically related to a particular page of the user interface.

2.1.1 WEB SERVER

This tab enables or disables the web server where some functionalities such as screensavers, licenses, etc. are managed.

ETS PARAMETERISATION

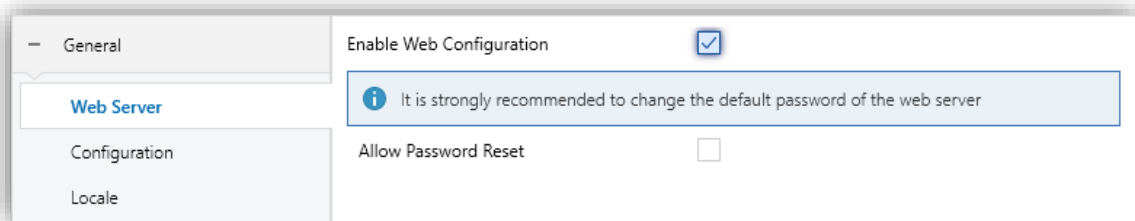

Figure 1. General. Web Server

The following parameters are shown:

- **Enable Web Configuration** [[disabled](#) / [enabled](#)]¹: enables or disables access to “Webserver Tools”, from which certain configuration and monitoring actions can be performed.
- **Allow Password Reset** [[disabled](#) / [enabled](#)]: enables the password for accessing the Web server to be set to the factory default.

¹ The default values of each parameter will be highlighted in blue in this document, as follows: [[default](#) / *rest of options*].

Please refer to the user manual “**Webserver Tools**” (available in the product section at the Zennio homepage, www.zennio.com) for detailed information about its functionality and the configuration.

Note: *in the event of a supply failure, the connection with the server will be lost, and waiting for the screen to recover its generic IP to access it again will be necessary.*

2.1.2 CONFIGURATION

The "Configuration" tab contains general settings. Most are checkboxes for enabling/disabling other functionalities.

ETS PARAMETERISATION

- General	Password for Administrator Privileges <input type="text"/>
Web Server	INPUTS <input type="checkbox"/> THERMOSTATS <input type="checkbox"/>
Configuration	Heartbeat (Periodic Alive Notification) <input type="checkbox"/> Device Recovery Objects (Send 0 and 1) <input type="checkbox"/>
Time Configuration	Internal Probe <input type="checkbox"/>
Locale	Default Theme (After Download) <input checked="" type="radio"/> Light <input type="radio"/> Dark
Backlight	Icons Type <input checked="" type="radio"/> Colourful <input type="radio"/> Monochromatic
Security	Show Time <input type="checkbox"/> Show Temperature <input checked="" type="radio"/> No <input type="radio"/> External Value
Update Settings	Remote Control through the Internet <input checked="" type="checkbox"/> Pairing Code Expiration Time <input type="text" value="120"/> x 1s Enable Administrator Pairing <input type="checkbox"/>
IP Configuration	<div style="border: 1px solid #ccc; padding: 2px; background-color: #e0e0e0;"> ⓘ The use of this functionality requires a specific licence </div>
+ Display	Update Objects <input type="text" value="Disabled"/>
	Bus Failure Notification Message <input type="checkbox"/>
	Screensaver <input type="checkbox"/>
	Time to Consider Inactivity <input type="text" value="30"/>
	<input checked="" type="radio"/> s <input type="radio"/> min
	Schedulers <input type="checkbox"/>
	Energy Monitor <input type="checkbox"/>
	Proximity Sensor <input checked="" type="checkbox"/>
	Ambient Luminosity Sensor <input type="checkbox"/>
	Touch Locking <input type="checkbox"/>
	Sounds <input checked="" type="radio"/> Default <input type="radio"/> Custom
	Advanced Configuration <input type="checkbox"/>

Figure 2. General. Configuration

The following parameters are shown:

- **Password for Administrator Privileges:** sets the administrator password for the screen.

- **Inputs** [*disabled / enabled*]: enables or disables the “Inputs” tab in the tree on the left, depending on whether the device will or will not be connected any external accessories. For more information, see section 2.3.
- **Thermostats** [*disabled / enabled*]: enables or disables the “Thermostat” tab in the tree on the left. For more information, see section 2.4.
- **Heartbeat (Periodic Alive Notification)** [*disabled / enabled*]: incorporates a one-bit object to the project (“**[Heartbeat] Object to Send ‘1’**”) that will be sent periodically with value “1” to notify that the device is still working (*still alive*).

Figure 3. Heartbeat

Note: *the first sending after download or bus failure takes place with a delay of up to 255 seconds, to prevent bus overload. The following sendings match the period set.*

- **Device Recovery Objects (Send 0 and 1)** [*disabled / enabled*]: this parameter lets the integrator activate two new communication objects (“**[Heartbeat] Device Recovery**”), which will be sent to the KNX bus with values “0” and “1” respectively whenever the device begins operation (for example, after a bus power failure). It is possible to parameterise a **delay** [*0...255*] for this sending.

Figure 4. Device Recovery Objects

Note: *after download or bus failure, the sending takes place with a delay of up to 6,35 seconds plus the parameterised delay, to prevent bus overload.*

- **Internal Probe** [*disabled / enabled*]: enables the internal temperature probe of the device.

- **Default Theme (After Download)** [[Light](#) / [Dark](#)]: enables choosing the device theme after download.
- **Icons Type** [[Colourful](#) / [Monochromatic](#)]: enables to choose whether the set of icons will be displayed in color or grayscale.

Note: *even if the monochrome option is chosen, some icons will still keep the colour, such as RGB or some pop-up icons.*

- **Show Time** [[disabled](#) / [enabled](#)]: permits setting whether the current time is displayed in the upper-left corner of any page or not.

Important: *the time will not be displayed on the top bar until both a time and a valid date have been set.*

- **Show Temperature** [[No](#) / [Internal Temperature Probe](#) / [External Value](#)]: sets whether the current temperature should show or not in the upper right corner of every page. If "[External Value](#)" is chosen, an object named "**[General] External Temperature**" will be enabled, so that it can be grouped with any other object that sends temperature values.

Enables to choose whether the source of the current temperature measurement will be an "[External value](#)" or the value provided by the "[Internal temperature probe](#)".

- **Remote Control through the Internet** [[disabled](#) / [enabled](#)] (license required): enables or disables remote control function (see [ANNEX III. Remote Control via IP](#)).

- **Pairing Code Expiration Time** [[60 ... 120 ... 3600](#)]: sets the time that pairing code will be valid.
- **Enable Administrator Pairing** [[disabled](#) / [enabled](#)]: enables the possibility of performing an administrator pairing through remote. This pairing is performed using the administrator password without press the pairing button on the display and it can only be deleted from the Zennio Remote application.

Note: *in order to perform this type of pairing it is necessary to contact the manufacturer to assign administrator permissions to the user account.*

- **Update Objects:** enables the sending of read requests to update status objects and indicators. There are four options available, some of them with a configurable delay:
 - [[Disabled](#)]: no read request, therefore objects are not updated.
 - [[After Programming](#)]: read requests are sent after a complete or partial download (or when pressing the reset button in the configuration page, if set as “[Parameters Reset](#)”, see section 2.2.1.2.1).
 - [[After Reset](#)]: read request are sent when a reset occurs (bus failure, the Reset Device ETS option or when pressing the reset button in the configuration page, if set as “[Application Reboot](#)”, see section 2.2.1.2.1), after the parameterised **delay** [[0...10...65535](#)] [[s / min / h](#)].
 - [[After Programming and Reset](#)]: combination of the two above options.
- **Bus Fail Notification Message** [[disabled](#) / [enabled](#)]: enables an informative message to be displayed on the screen with each press during a bus failure.
 - **Message** [[Bus Failure](#)]: textbox to enter the desired message.



Figure 5. Bus Fail Message

- **Screensaver** [[disabled](#) / [enabled](#)] / [[disabled](#)]: enables the screensaver. This parameter is only available if the internal temperature sensor is disabled. See section 2.1.9.
- **Time to Consider Inactivity:** time that must elapse since the last press and/or proximity detection to consider inactivity state. Then the display backlight will dim. See section 2.1.5.
 - **With internal probe enabled:** [[30...65535](#)] [[s](#)] / [[1...65535](#)] [[min / h](#)]

- **With internal probe disabled:** `[[30...600] [s] / [1...10] [min]]`
- **Schedulers** `[disabled / enabled]`: enables schedulers functionality. When enabled, a new tab is added in the tree on the left. See section 2.1.7.
- **Energy Monitor** `[disabled / enabled]`: enables energy monitor functionality. When enabled, a new tab is added in the tree on the left. See section 2.1.8.
- **Proximity Sensor** `[disabled / enabled]`: enables the proximity sensor. This functionality permits “waking up” the device display when detecting presence through the proximity sensor.

Please refer to the user manual “**Proximity and Luminosity Sensor**” (available in the product section at the Zennio homepage, www.zennio.com) for detailed information about the functionality and the configuration of the related parameters.

Note: *After programming or resetting the device, 1 minute is required to carry out the sensors calibration. To achieve a correct calibration, during this time, keeping a distance of more than 50 cm from the sensors and avoiding light falling directly on them is recommended.*

- **Ambient Luminosity Sensor** `[disabled / enabled]`: enables or disables the ambient luminosity sensor. When enabled, a new tab is added in the tree on the left (see section 2.1.11).
- **Touch Locking** `[disabled / enabled]`: enables or disables the possibility of locking the touch by object. When enabled, a new tab is added in the tree on the left (see section 2.1.12).
- **Sounds** `[Default / Custom]`: sets whether the sound functions (button beeps and doorbell) should work according to the pre-defined configuration (“Default”) or to a user-defined configuration (“Custom”) (see section 2.1.13).
- **Advanced Configuration** `[disabled / enabled]`: enables “Advanced” tab. See section 2.1.18.

The project topology shows the following objects by default:

- “[**General**] **Time of Day**”: 3-byte object for setting the internal time of the device, for example, by linking it to a KNX clock. This object is also automatically sent after time changes made by the user from the screen itself.

Note: *although the DPT of this object considers a field for setting the day of the week, the screen calculates it from the date and therefore ignores that field.*

Important: *Z50 / Z70 v2 / Z100 does not have an RTC clock or battery to keep track of the time in the absence of power. Therefore, it is important to receive the time periodically from a device that obtains it through NTP and/or has a battery to prevent delays during bus failures.*

- “[**General**] **Date**”: 3-byte object for setting the internal date of the device, for example, by linking it to a KNX clock. This object is also automatically sent after date changes made by the user from the screen itself.
- “[**General**] **Scene: Send**” and “[**General**] **Scene: Receive**”: objects for respectively sending and receiving scene values from/to the KNX bus whenever it is necessary.
- “[**General**] **Activity**”: 1-bit object to force activity/inactivity state on the device. For further information, please refer to the user manual “**Proximity and Luminosity Sensor**” and “**Brightness**” (available in the product section at the Zennio homepage, www.zennio.com).
- “[**General**] **Localization – Select**” and “[**General**] **Translations – Select**”: 4-byte and 2-bytes objects to change, respectively, the locale and the language in the screen (see section 2.1.3).
- “[**Profile**] **Theme**”: 1-byte object to change the theme used in the screen.
- “[**Profile**] **Volume**”: 1-byte percentage object to change the volume at which the user sounds of device will be emitted.
- “[**C001**] **Switch Indicator**”: object associated with Control 1 enabled by default.
- “[**Profile**] **Display – Brightness**”: 1-byte percentage object to change the display brightness level.

- “[General] Proximity Sensor”, “[General] External Proximity Detection” and “[General] Proximity Detection”: 1-bit object whose functionality is tied to the proximity sensor. For further information, please refer to the user manual “Proximity and Luminosity Sensor” (available in the product section at the Zennio homepage, www.zennio.com).
- “[Internal Temp. Probe] Current Temperature” (only in Z50 and Z70 v2): 2-byte object through which the value of the current measurement of the built-in sensor will be sent to the bus, according to the parameterisation (see section 2.1.10).

2.1.3 TIME CONFIGURATION

This tab configures everything related to the time configuration (NTP clock, time zone, etc.).

The sunrise and sunset functionality is also enabled, which sends a 1-bit value to the bus each day at sunrise and sunset. This requires configuring the location where the device is located to send these objects accurately.

ETS PARAMETERISATION

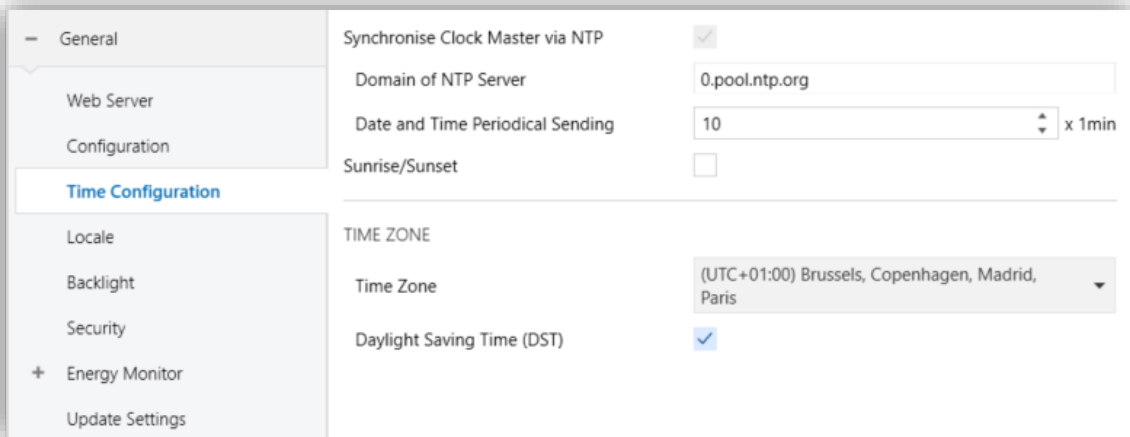

Figure 6. Time Configuration

- **Synchronize Clock Master via NTP** [*disabled* / *enabled*]: if enabled, the device will update the date and time obtained from the NTP server according to the configured time zone. In addition, the following parameters will be displayed:

- **Time Zone:** drop-down list to select a time zone from the UTC (Coordinated Universal Time) time standard.
 - **Daylight Saving Time (DST)** [[disabled](#)] / [[disabled / enabled](#)]: enables or disables the automatic time change during the summer season. It will only be available in the time zones that have summer time changeover.
- **Domain of NTP Server** [[0.pool.ntp.org](#)]: NTP server used for internal clock synchronisation.
- **Date and Time Periodical Sending** [[0 ... 10 ... 65535](#)] [[x 1 min](#)]: time period after which the date and time objects (“**[General] Date**” and “**[General] Time of Day**”) will be sent to the bus.

If the parameter **Synchronize Clock Master via NTP** is disabled, the following parameter is displayed:

- **Date and Time Update Request Delay** [[disabled / enabled](#)]: allows selecting a **delay** [[1...65535](#)] [[s / min / h](#)] for the date and time request to the bus. These requests will be made after updating the firmware or after power failure.
- **Sunrise/Sunset** [[disabled / enabled](#)]: enables the sunrise and sunset functionality. When enabled, the following parameters are displayed for configuring the location where the device is located:
 - **Latitude** [[North / South](#)]
 - **Degrees** [0 - 90°] [[0... 40 ... 90](#)]
 - **Minutes** [0 – 59'] [[0... 25 ... 59](#)]
 - **Longitude** [[East / West](#)]
 - **Degrees** [0 - 180°] [[0... 3 ... 180](#)]
 - **Minutes** [0 – 59'] [[0... 42 ... 59](#)]

With the sunrise/sunset functionality, the following parameters will also be shown:

- **Binary objects** [[disabled / enabled](#)]: enables the sending of the binary objects “**[Sunrise/Sunset] Event at Sunrise**” and “**[Sunrise/Sunset] Event at Sunset**” to the bus when the sunrise and sunset time is reached, being possible to configure the value to be sent in each case.

- **Scene object** [[disabled](#) / [enabled](#)]: sets the scenes to be sent through the general scene object when the sunrise and sunset times are reached.

2.1.4 LOCALE

The **locale** consists of a language and region identifier, which will determine the language and how certain visual aspects of the device are displayed, such as:

- The temperature scale: Celsius or Fahrenheit.
- Time format: 12 or 24 hours.
- Date format: dd-mm-yyyy, mm-dd-yyy o yyyy-mm-dd.
- Use of a point (.) or a comma (,) for decimal separation (except in temperature that will always be shown with a point as separator).
- Position of the currency symbol in cost indicators.
- Language of all the texts shown on the screen.

Example 1: *Locale: es-ES → Language: Spanish – Region: Spain.*

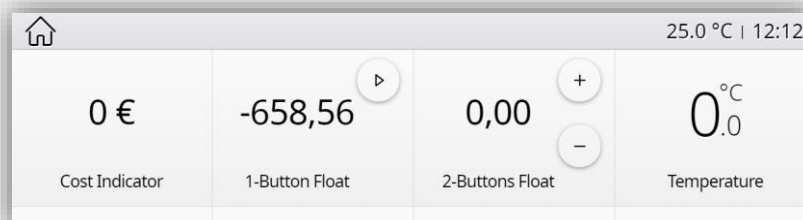

Figure 7. Locale es-ES

Example 2: *Locale: en-US → Language: English – Region: USA.*

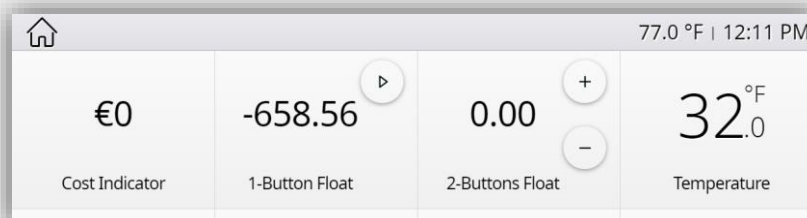

Figure 8. Locale en-US

The **locale** configuration can be selected through three types of communication objects:

- **A 1-byte object.** Enumerated to select **the locale and the language** from any of the configured in ETS.
- **A 2-bytes object.** Allows changing the **language** without affecting the region.
- **A 4-bytes object.** Allows changing **the locale and the language** by sending a language-region pair of values.

Note: *if a language change is made while a pop-up is open, this change will not take effect until the pop-up is closed.*

Please refer to section 2.1.14.3 for detailed information about the process of importing and exporting language translation files.

ETS PARAMETERISATION

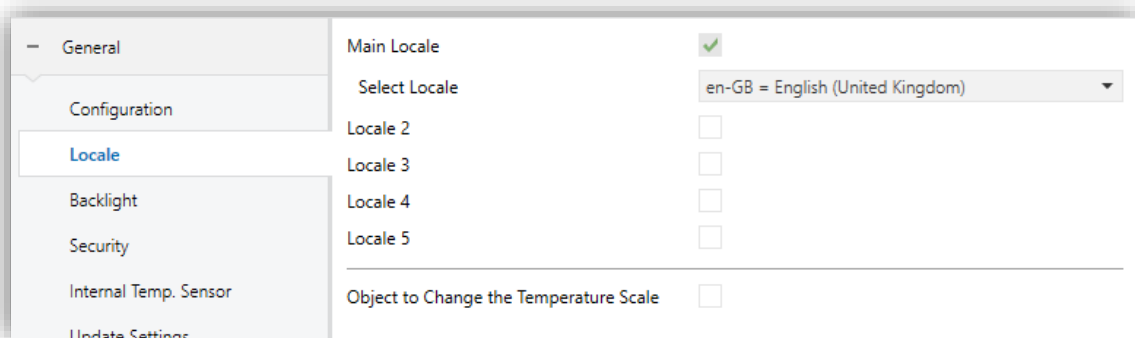

Figure 9. Locale

- **Main Locale** [*enabled*]: read-only parameter to make it evident that the main locale is always enabled.
 - **Select Locale:** list of the available locales.
- **Locale X** [*disabled / enabled*]: enables the additional locale X.
 - **Select Locale:** list of the available locales.

The language and locale are changed via the following communication objects:

- **1-byte object “[General] Localization - Select”.** To select the locale and the language from any of the configured in ETS.
 - The expected values in this object are fixed, from 0 to 4. When one of these values is received, the texts of the file ‘text_language-region.xlf

corresponding to the regional configuration associated with this value will be loaded.

- If the received value does not correspond to any enabled locale, the main locale will be loaded.

Note: *this object is only available if more than one locale is enabled in ETS.*

● **4-bytes object “[General] Localization - Select”.**

- The values expected by this object are four characters, **language-region** pair, corresponding to ISO 639-1 and 3166-1 respectively.
- When a valid language-region code is received, the texts from the '*text_language-region.xlf*' file and the indicated region will be loaded. In case there is not that file, the main locale configuration will be loaded. If the region does not correspond to the language or it is not valid, the default region associated with that language will be set (and the language file '*text_language-ZZ.xlf*', if it exists).

● **2-bytes object “[General] Translations - Select”.** To change the Language without affecting the region.

- The values expected by this object are the language code corresponding to ISO 639-1.
- When a valid language code is received, the texts from the '*text_language-ZZ.xlf*' file will be loaded. In case there is not that file, the language of the main locale configuration (texts from ETS) will be loaded.

Example:

Imported files: '*text_es-ES.xlf*', '*text_es-ZZ.xlf*' y '*text_es-AR.xlf*'.

ETS Parameterization:

Main Locale: en-GB

Locale 2: es-AR

Locale 3: fr-FR

1-byte object: 1 → Language: '*text_es-AR.xlf*' – Region: Argentina.

1-byte object: 2 → Language: '*dflt.xlf*' (ETS texts) – Region: Great Britain.

1-byte object: 4 → Language: '*dflt.xlf*' (ETS texts)– Region: Great Britain.

2-byte object: en → Language: '*dflt.xlf*' (ETS texts) – Region: No change.

2-byte object: *es* → Language: 'text_es-ZZ.xlf' – Region: No change.

2-byte object: *fr* → Language: 'dflt.xlf' (ETS texts) – Region: No change.

4-byte object: *es-ES* → Language: 'text_es-ES.xlf' – Region: Spain

4-byte object: *es-AR* → Language: 'text_es-AR.xlf' – Region: Argentina

4-byte object: *fr-FR* → Language: 'dflt.xlf' (ETS texts) – Region: Great Britain.

4-byte object: *es-VE* → Language: 'dflt.xlf' (ETS texts) – Region: Great Britain

4-byte object: *es-aa* → Language: 'text_es-ZZ.xlf' – Region: Spain

Note: For further information about the process of importing and exporting translation files into the different languages, see section 2.1.14.3.

- **Object to change the temperature scale** [*disabled* / *enabled*]: enables or disables the 1-bit object “[General] Temperature scale”, which permits changing the scale of the temperatures. By receiving one ‘0’ through this object, the scale will switch to Celsius, while after receiving one ‘1’ it will switch to Fahrenheit.

The selected scale applies to any temperatures shown on the screen and takes precedence over the scale corresponding to the locale.

2.1.5 BACKLIGHT

Z50 / Z70 v2 / Z100 enables managing the brightness of the display according to two operating modes: normal mode and night mode.

Note: Contrast is not a configurable feature in the device.

Please refer to the specific manual “**Brightness**” (available in the product section at the Zennio website, www.zennio.com) for detailed information about the functionality and the configuration of the related parameters.

2.1.6 SECURITY

Any box or page will be given the possibility of **restricted access by password**. Up to **two security levels** can be configured, with the level 2 access password taking priority over the level 1 password, so that any controls page or box can be protected by one or the other, or by none at all.

Buttons that lead to a protected page or box will show a little **lock** icon overlaid on their lower right corner. Figure 10 shows the “enter password” dialog shown to the user when trying to access a protected page.



Figure 10. Security pop-up

In case of setting up **two levels**, the first one is assumed to be *enclosed* by the second one. This means that whenever the device asks the user to type password #1 (to enter a certain item); password #2 will also be accepted. On the contrary, password #1 cannot be used instead of password #2. This behaviour permits, therefore, making password #2 available to users with further privileges while password #1 is assigned to users with fewer privileges.

Moreover, when accessing to a protected page, all the boxes and pages with the same or lower access level of the introduced password, are automatically unlocked. It can be set if the elements are relocked after pressing the Home Button. Anyway, security is reactivated when the time for considering inactivity expires.

ETS PARAMETERISATION

This screen permits selecting how many security levels (one or two) will be available for the configuration of the access to the control pages or the boxes.

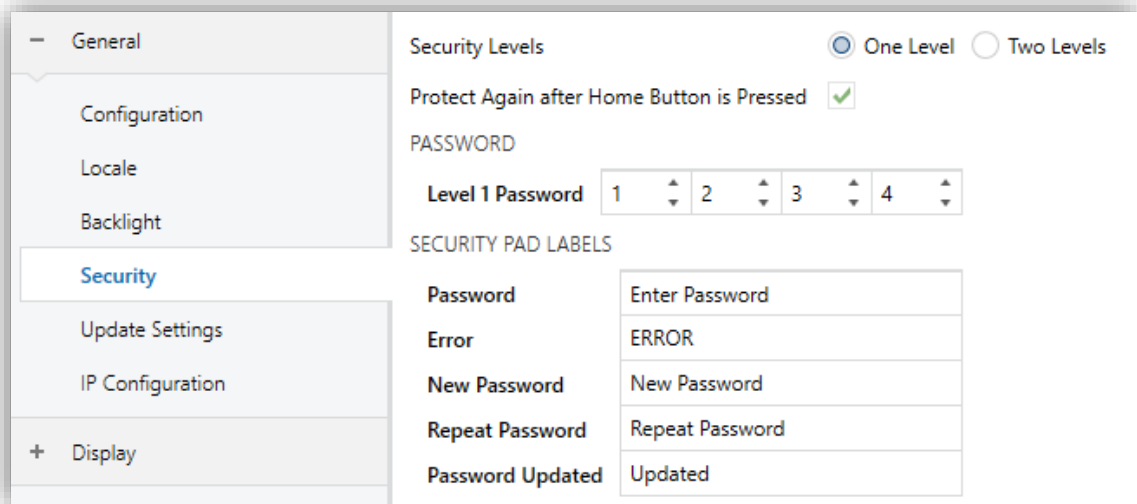

Figure 11. Security

- **Security Levels** [[One Level](#) / [Two Levels](#)]: parameter for selecting whether one or two security levels will be available.

Note: with independence of the option selected here, it will be necessary to establish the security level desired for each specific page of controls.

- **Protect Again after Home Button is Pressed** [[disabled](#) / [enabled](#)]: if enabled, the security of the boxes and/or pages will be restored when the Home Button is pressed.
- **Password** [Level 1: [1234](#); Level 2: [5678](#)]: parameter made of four additional textboxes, each of which should contain one of the four consecutive digits [0...9] that will compose the password. In case of enabling two security levels, the Password parameter will show twice, being the first one referred to the password of Level 1, and the second one to the password of Level 2.

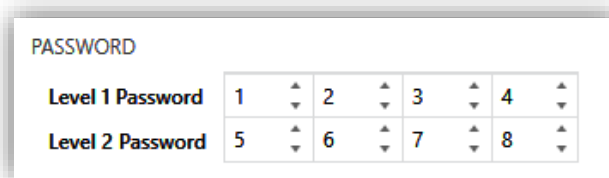

Figure 12. Two security levels

Important: the password insertion dialog features a specific option (lower left button) that lets the user change, in runtime, the passwords originally set by parameter. After accessing this option and prior to typing the new password, the

text box will be set with an orange background and the user will be required to type the corresponding old password (level 1 or level 2). Note that although it will be possible to type password 2 even if the device asks for password 1, the new password typed afterwards will be anyway stored as the new password for level 1.

- **Security Pad Labels:** parameter consisting in six additional textboxes, intended for the customisation of the messages that the device shows (or may show) when the user interacts with the password insertion dialog.
 - **Password 1** [[Enter Password 1](#)]: message shown when the user is required to type in the password for level 1.
 - **Password 2** [[Enter Password 2](#)]: message shown when the user is required to type in the password for level 2.
 - **Error** [[ERROR](#)]: message shown to the user when the typed password is not valid.
 - **New Password** [[New Password](#)]: message shown to ask the user for a new password, during the password change process.
 - **Repeat Password** [[Repeat Password](#)]: message shown when the user is required to re-type the new password.
 - **Password Updated** [[Updated](#)]: message shown to the user as a confirmation of the password change.

2.1.7 SCHEDULERS

Z50 / Z70 v2 / Z100 offers the possibility to enable up to **30 schedulers**, within which the execution of up to 30 timed sending actions to the KNX bus can be configured.

Timed actions are performed on the **programmable controls** that have been configured in the device:

- **1-Button Controls:**
 - Switch.
 - Scene
 - Two Object (Short Press/Long Press²).
 - Hold & Release.
 - Enumeration.
 - Constant (Counter / Scaling / Float).

● 2-Button Controls:

- Switch.
- Two Object (Short Press/Long Press²).
- Counter.
- Scaling.
- Float.
- Enumeration.
- Shutter.
- Dimmer.

● Climate Specific Controls:

- Temperature Setpoint control.
- Mode.
- Special modes.
- Fan.

● Other Controls:

- RGB Control.
- Macro.
- RGBW Control.

To adjust the scheduler configuration settings, access the configuration panel from any of the boxes that have been parameterised as "scheduler" type (see section 2.2.2.1.5.8). From this panel navigation to the rest of the available schedulers will be possible, each of them represented by its corresponding icon configured from ETS.

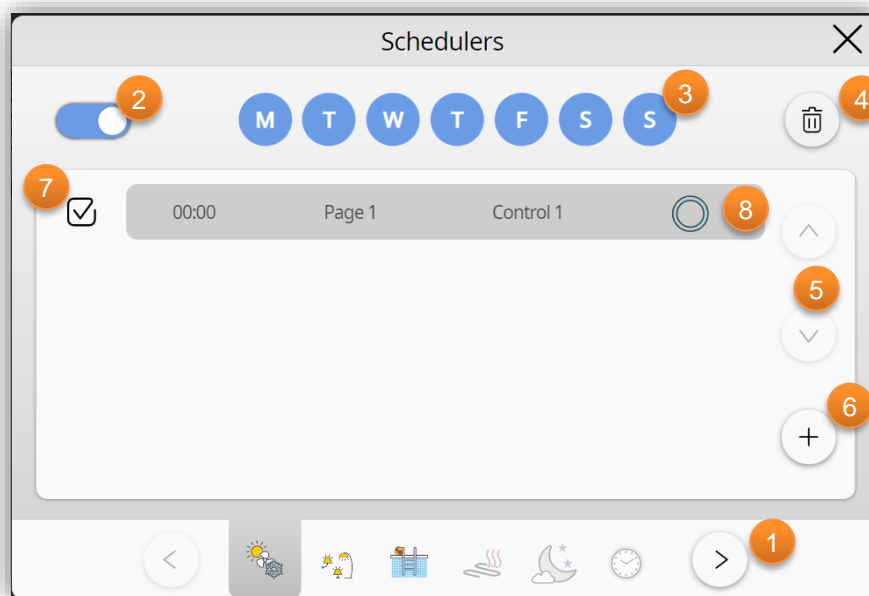

Figure 13. Schedulers panel

The scheduler panel consists of:

² In the case of two-object controls (Short Press/Long Press), the schedulers only take into account the short press value.

- 1 **Navigation area between schedulers** by means of the arrow buttons or by clicking directly on the icon of the scheduler to be displayed.
- 2 **General enable** button to enable/disable the scheduler without deleting the actions.
- 3 **Days of the week** on which the actions configured in the selected scheduler are to be executed.
- 4 Button to **delete all the actions** of the scheduler.
- 5 **Navigation area through the scheduler actions.**
- 6 Button to **add a new action** at the end of the list.
- 7 Checkbox to **deactivate an action individually** without deleting it.

- 8 **Timed action** which will show the **time** of execution, the **page** where the control is located, the **control** to be timed and the **value** to be sent once the configured time has been reached. In case the **Sunrise/sunset** functionality is enabled (see section 2.1.3), a selector shall also be displayed to configure the sending with respect to the time of sunrise or sunset.

The configuration of actions is done by entering edit mode. This happens when a new action is added or when clicking on one of the panel visible actions. Entering edit mode expands the action, showing the buttons to modify each field and a new button to delete the action, as shown in Figure 14.



Figure 14. Edit mode for scheduler actions

Saving the configured actions occurs when navigating to another scheduler or closing the panel by clicking outside the editing dialogue.

Note: *if there are any protected controls, these can only be timed if the panel is accessed with a security level equal to or higher than that of the control. Otherwise, these actions are hidden. Besides, if any action is configured with a higher security level than the current one, it will be notified with a padlock and it will not be allowed to modify the global actions of the scheduler (**general enabling, days of the week and deleting all actions**).*

Each of the schedulers may be enabled/disabled either from the panel or from the scheduler communication object "[Px] Scheduler - Enable".

ETS PARAMETERISATION

After enabling **Schedulers** from "Configuration" screen (see section 2.1.2), a new tab will be incorporated into the tree on the left.

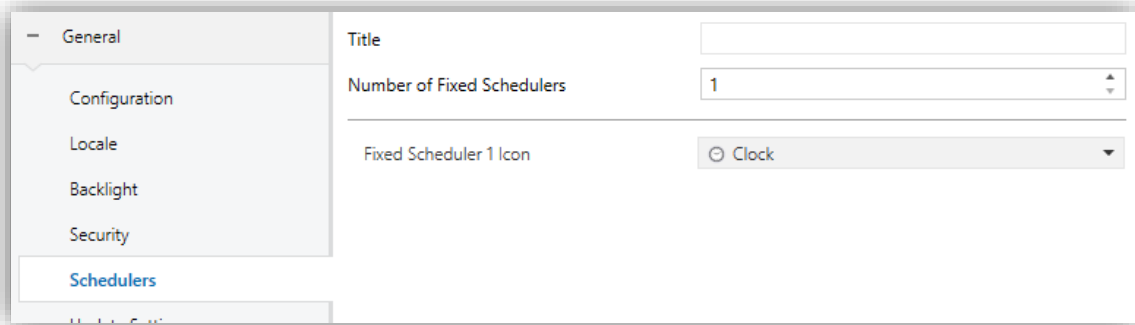

Figure 15. Schedulers tab

- **Title:** text displayed at the top of the general scheduler panel.
- **Number of Fixed Schedulers** [[1...30](#)]: sets the number of schedulers available for setting on the display.
 - **Fixed Scheduler n Icon** [[Clock](#)]: selects the icon to be displayed in the navigation area for each scheduler.

2.1.8 ENERGY MONITOR

The Energy Monitor control offers the possibility of **displaying energy and power consumption**, both for the house as a whole and for individual devices.

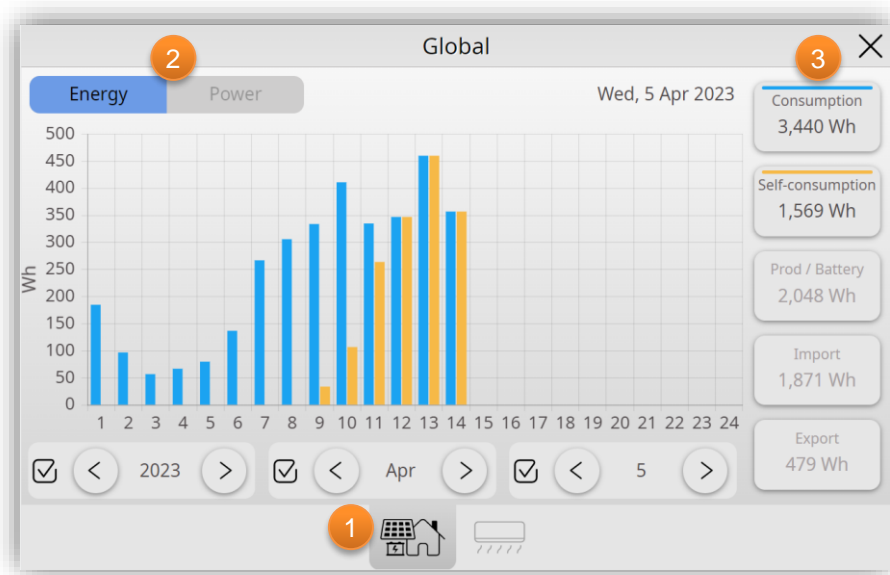

Figure 16. Energy Monitor - Global Tab

The panel of Energy Monitor consist of:

- 1 Navigation area between tabs of:
 - **Global measurements of the house** (consumption, solar production...)
 - **Individual device consumption.** It is possible to enable up to 4 individual consumption tabs with 6 devices each.

Navigation between the different tabs is done by clicking on the icons on the bottom bar of the panel.

- 2 Navigation area between graphs of:
 - **Energy:** has a zoom by day, month, year, and the history of the last 10 years. The values are represented with a bar graph, and in the case of the devices tab, the representation can be stacked or not.
 - **Power:** has an hour and day zoom, storing the data received for the last 30 days. The values are represented with a step-type graph.

For further information about graphs navigation see ANNEX IV. Graphs.

- 3 **Selectors of magnitudes/devices.** Allow to show or hide these values in the graph by clicking on the corresponding box.

The magnitudes shown depend on the house **installation type**:

- **No Solar Panels and No Battery:** in this case there is only one measurement point so only consumption data can be obtained.
- **Solar Panels without Battery / with Battery:** the following values can be displayed in the global tab:
 - **Consumption:** total energy consumed in the house.
 - **Self-consumption:** energy generated that has been consumed in the house.
 - **Production / Battery:** energy generated by the solar installation.
 - **Import:** energy imported from the electricity grid.
 - **Export:** energy exported to the electricity grid.

For more information about the configuration of the energy monitor, see [ANNEX V. Energy monitor configuration.](#)

ETS PARAMETERISATION

After enabling **Energy monitor** from “Configuration” screen (see section 2.1.2), a new tab will be incorporated into the tree on the left.

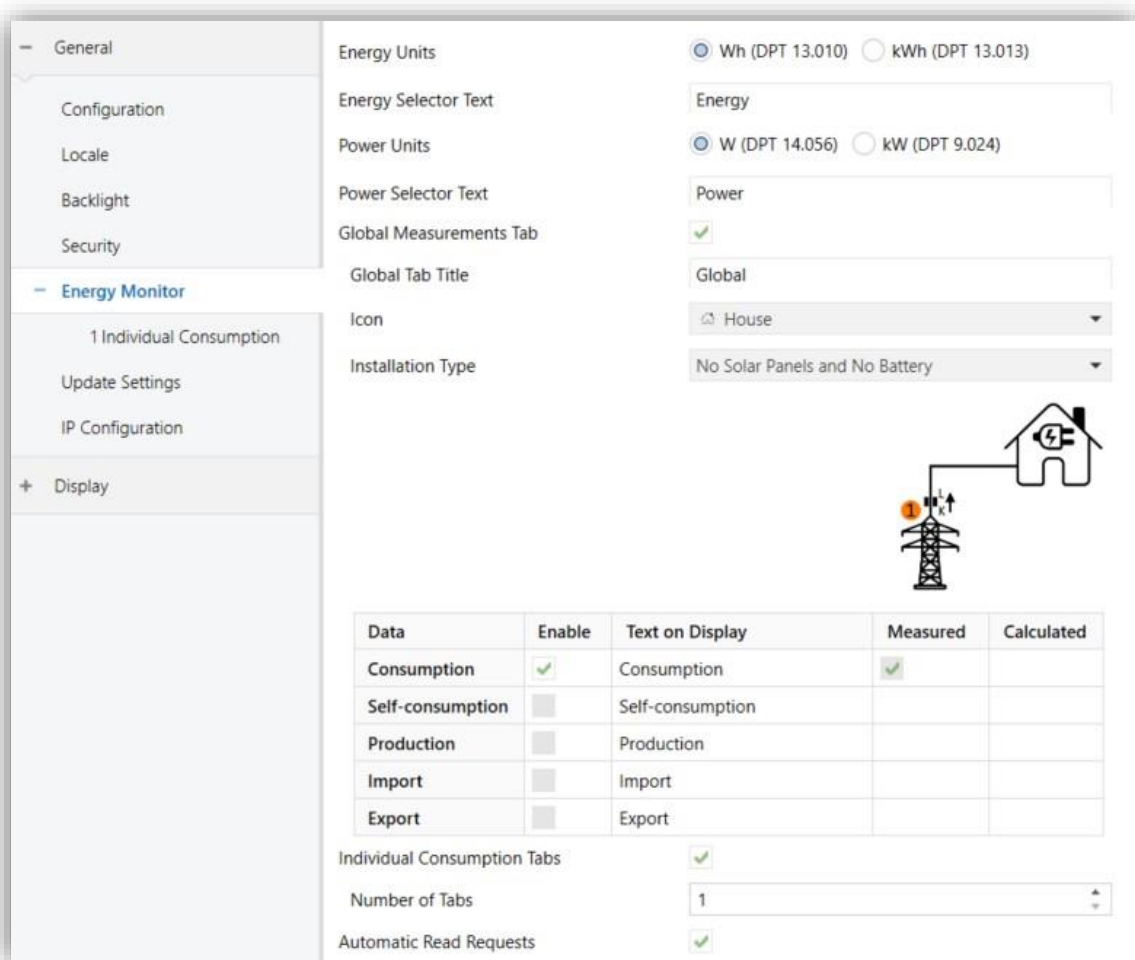

Data	Enable	Text on Display	Measured	Calculated
Consumption	<input checked="" type="checkbox"/>	Consumption	<input checked="" type="checkbox"/>	
Self-consumption	<input type="checkbox"/>	Self-consumption		
Production	<input type="checkbox"/>	Production		
Import	<input type="checkbox"/>	Import		
Export	<input type="checkbox"/>	Export		

Figure 17. Energy monitor tab

- **Energy units** [[Wh \(DPT 13.010\)](#) / [kWh \(DPT 13.013\)](#)]: sets the DPT of the energy objects. Regardless of the option chosen, the monitor will always display values below 1000 Wh in Wh and values above 1000 Wh in kWh.
- **Energy Selector Text** [[Energy](#)]: this text field allows choosing which text will be displayed for energy graph selector.
- **Power units** [[W \(DPT 14.056\)](#) / [kW \(DPT 9.024\)](#)]: sets the DPT of the power objects. Regardless of the option chosen, the monitor will always display values below 1000 W in W and values above 1000 W in kW.
- **Power Selector Text** [[Power](#)]: this text field allows choosing which text will be displayed for power graph selector.

- **Global Measurements Tab** [disabled / enabled]: enables the global measurements tab.
 - **Global Tab Title** [Global]: sets the text displayed at the top of screen of the global measurement tab.
 - **Icon** [House]: sets the icon of the global measurement tab.
 - **Installation Type** [No Solar Panels and No Battery / Solar Panels without Battery / Solar Panels with Battery]: In case of choosing an installation with solar panels the following parameter will be displayed:
 - **Is There House Measuring Point? (Point 3)** [disabled / enabled]: parameter to indicate whether there is a measuring point in the house such as point 3 in the diagram.

Below is a table with the different magnitudes that can be enabled (this will depend on the type of installation configured in ETS). In the same table, the text that will appear in the legend is also configured and it is indicated whether the magnitudes are calculated or measured:

- **Consumption**: enables “[EM] Consumed Energy” and “[EM] Consumed Power” objects.
- **Self-consumption**: this data is always calculated, so it has no object associated.
- **Production**: enables “[EM] Produced Energy” and “[EM] Produced Power” objects.
- **Importation and exportation**: enables “[EM] Imported Energy” and “[EM] Exported Energy” objects respectively, while in power data case there is one shared object “[EM] Imported/Exported Power”.

Note: *communication objects will only be displayed when the enabled data is marked as measured.*

- **Individual Consumption Tabs** [disabled / enabled]: enables the individual consumption tabs. In addition, the parameter appears:
 - **Number of tabs** [1 / ... / 4]: sets the number of individual consumption tabs.
- **Automatic Read Requests** [disabled / enabled]: if enabled, the display sends read requests at the end of each hour for all energy objects.

- **Split Imported/Exported Power into Two Objects** [[disabled](#)/[enabled](#)]: split the imported/exported power object into two separate objects.

2.1.8.1 INDIVIDUAL CONSUMPTION N

In case of enabling individual consumption tabs, subtabs will appear on the tree of the left with the following parameters:



Figure 18. Individual consumption tab

- **Tab title:** defines the individual consumption tab title.
- **Tab Icon** [[AC](#)]: sets the icon which will be displayed on the corresponding individual consumption tab.
- **Number of Devices** [[1](#) / ... / [6](#)]: sets the number of devices which will be displayed on an individual consumption tab. The objects "[EM][ICX][DX] Consumed Energy" and "[EM][ICX][DX] Consumed Power" will be added for each enabled device.
- **Device Name N:** text field which allows defining the device name from the N enabled devices.

2.1.9 SCREENSAVER

The touchscreen offers the possibility to display a screensaver after a **period of inactivity**, configurable by parameter.

The screensaver can be configured to only show the current **Time**, the current **external Temperature** or **both**.



Figure 19. Screensaver

There will also be an option to show an image on the screensaver. This image will be loaded from the webserver.

Note: Please refer to the user manual “**Webserver Tools**” (available in the product section at the Zennio homepage, www.zennio.com) for detailed information about its functionality and the configuration.

The screensaver disappears when activity is triggered (either by a pulsation, proximity detection or any other event that triggers activity).

Notes:

- If a Pop-Up is being displayed (see section 2.1.18.2), screensaver will not become active.
- If a pop-up is activated when the screensaver is active (see touch locking 2.1.12, cleaning function 2.1.18.1 or Pop-Ups 2.1.18.2) this pop-up will become show up over screensaver.

ETS PARAMETERISATION

After enabling **Screensaver** from “Configuration” screen (see section 2.1.2), a new tab will be incorporated into the tree on the left.

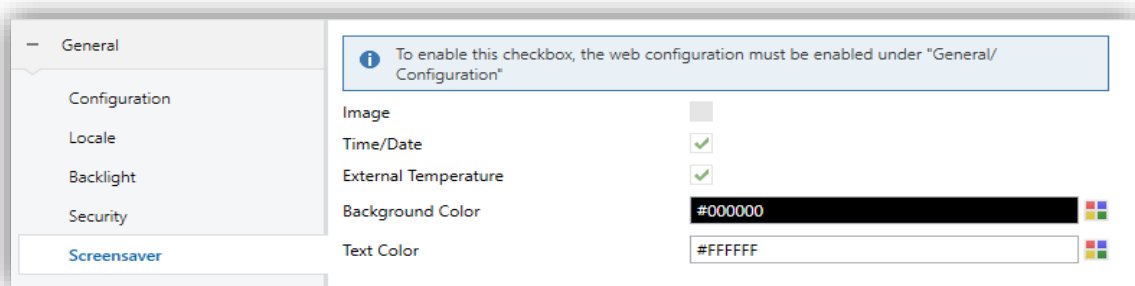

Figure 20. Screensaver Tab

- **Image** [[disabled](#)]: parameter to show an image in the screensaver. For this functionality to be available, the **Enable Web Configuration** parameter must be active (see section 2.1.2).
- **Time/Date** [[disabled](#) / [enabled](#)]: when this parameter is enabled, the current date and time is displayed centered on the screensaver.
- **External Temperature** [[disabled](#) / [enabled](#)]: when this parameter is enabled, the external temperature received by the “[**General**] **External Temperature**” object is displayed centered on the screensaver.
- **Background Color** [[#000000](#)]: color set for the background when there is no image in the screensaver.
- **Text Color** [[#FFFFFF](#)]: screensaver font color.

2.1.10 INTERNAL TEMPERATURE SENSOR

The touchscreen is equipped with **an internal temperature sensor** for monitoring the ambient temperature of the room, so that the device can report it to the KNX bus and trigger several actions when the temperature reaches certain values.

Please refer to the specific documentation of the “**Temperature Probe**” available at the Zennio homepage, www.zennio.com, for detailed information about the functionality and the configuration of the related parameters.

Note: *To ensure correct measurement of the temperature probe, when the temperature probe is enabled, the display will be permanently switched on.*

2.1.11 AMBIENT LUMINOSITY SENSOR

The touchscreen includes a sensor to measure the ambient luminosity level, so that the brightness of the display can be adjusted according to the current luminosity of the room.

Please refer to the specific manual “**Luminosity and Proximity Sensor**” (available in the product section at the Zennio homepage, www.zennio.com) for detailed information about the functionality and the configuration of the related parameters.

2.1.12 TOUCH LOCKING

The touch panel can be optionally locked and unlocked anytime by writing a configurable one-bit value to a specific object provided for this purpose. It can also be done through scene values.

While locked an informative message will be shown. In addition, any user presses on the screen will be ignored: no action associated with controls will be carried out.



Figure 21. Touch Locked Message

ETS PARAMETERISATION

After enabling **Touch Locking** from “Configuration” screen (see section 2.1.2) a new tab will be incorporated into the tree on the left.

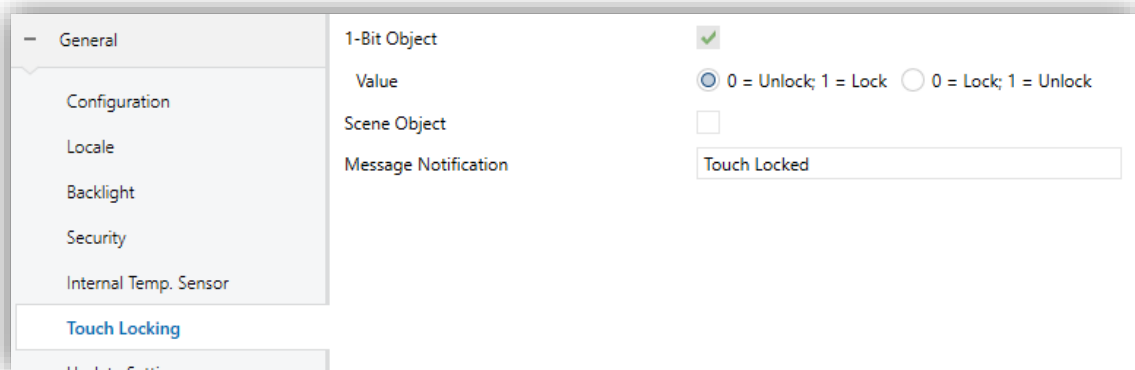

Figure 22. Touch Locking

- **1-Bit Object** [[enabled](#)]: enables the 1-bit object “[**General**] Touch Locking” to trigger the touch lock.
- **Value** [[0 = Unlock, 1 = Lock](#) / [0 = Lock, 1 = Unlock](#)]: parameter to select which value should trigger which action when received through the indicated object.

- **Scene Object** [[disabled](#) / [enabled](#)]: enables the touch locking and unlocking when receiving the configured scene value through the object (“**[General] Scene: receive**”).
 - **Lock: Scene Number (0 = Disabled)** [[0/1...64](#)]: scene number that locks the touch.
 - **Unlock: Scene Number (0 = Disabled)** [[0/1...64](#)]: scene number that unlocks the touch.
- **Message Notification** [[Touch Locked](#)]: textbox to enter the desired message.

2.1.13 SOUNDS

The touchscreen emits **3 types of sounds**, depending on the action performed:

- **Press Confirmation:** short beep indicating that the user has pressed a button. This only applies to step controls, i.e., controls that go through a certain range of values and that do not send a value after every touch, and to page accesses.
- **Sending Confirmation:** a slightly longer and sharper beep than the previous one. It indicates the sending of an object to the bus as a result of a press.
- **Doorbell:** sharp and longer beep than the previous one, high intensity. The volume and ringtone of the doorbell can be chosen by parameter, object or from the screen itself.

Enabling and disabling of this function can only be done by parameter. If enabled, the volume of the press and sending confirmation sounds will be possible to define.

ETS PARAMETERISATION

After enabling the “[Custom](#)” configuration of **Sounds** from “Configuration” screen (see section 2.1.2), a new tab will be incorporated into the tree on the left.

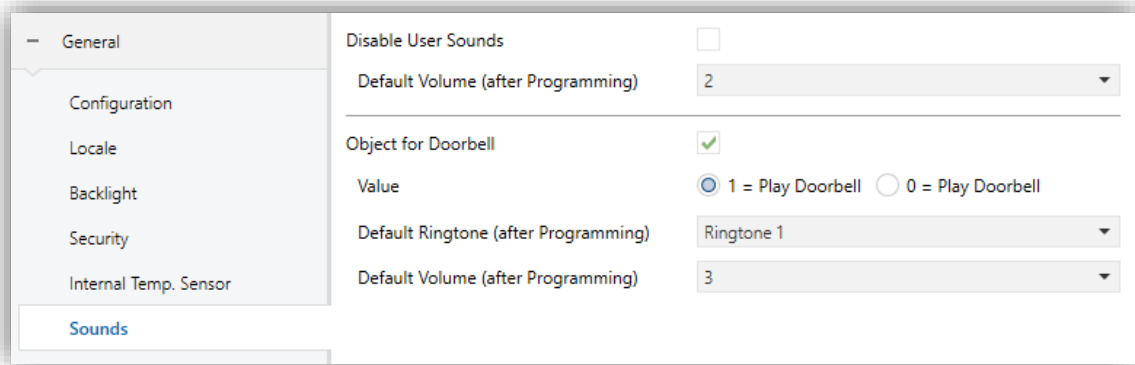

Figure 23. Sounds

The initial configuration of this screen is equivalent to the default option. However, the following parameters will be configurable.

- **Disable User Sounds** [*disabled / enabled*]: enables or disables acoustic signals when actions derived from button presses are executed. If enabled, the following parameter will be displayed:
 - **Default Volume (after Programming)** [*No Sound / 1 / 2 / 3*]: volume at which press and sending confirmation sounds will be emitted after ETS download.
- **Object for Doorbell** [*disabled / enabled*]: enables or disables the doorbell function. If enabled, a specific object (“**[General] Doorbell**”) will be included into the project topology.
 - **Value** [*0 = No Action, 1 = Doorbell / 0 = Doorbell, 1 = No Action*]: parameter to select which value should trigger which action when received through the indicated object.
 - **Default Ringtone (after Programming)** [*Ringtone 1 / ... / Ringtone 7*]: desired melody for doorbell after ETS download.
 - **Default Volume (after Programming)** [*No sound / 1 / 2 / 3 / 4 / 5*]: volume of the doorbell sound after ETS download.

2.1.14 UPDATE SETTING

It is possible upgrading via USB some of the available functions. These functionalities and how they should be updated are described in the following sections.

ETS PARAMETERISATION

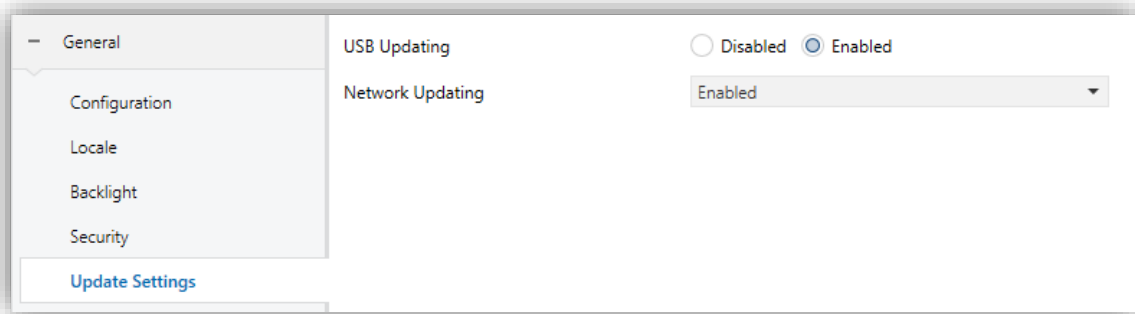

Figure 24. Firmware Update

- **USB Updating** [*Disabled / Enabled*]: enables or disables the device firmware update through the USB port. Thus, if this parameter is disabled, any action requiring the use of USB will have no effect.
- **Network Updating:** [*Disabled / Enabled / Enabled (Password Protected)*]: the latter brings the option to restrict the updates via Ethernet to those who can provide the required password to the update tool before the firmware download starts. This password, consisting in four numbers, needs to be set in ETS by the integrator.

Note: *reading the specific user manual of the firmware update process available at the Zennio webpage is encouraged, as it contains particular remarks regarding the password protection.*

2.1.14.1 FIRMWARE UPDATE

For detailed information about the update process, please refer to the “**Firmware update**” specific document, available at www.zennio.com.

Important:

- *Firmware updates do not re-set the alarm and error logs, nor does it clear the on-screen user configuration.*
- *Firmware updates via USB can be disabled in parameters (see section 2.1.14). Please bear in mind that if such possibility is left disabled and a new version of the application is downloaded before having updated the firmware to the corresponding version, then it will not be possible to re-enable it unless the application program is reverted to the version that corresponds to the current*

firmware version. In other words: the device does not apply any further parameter changes in case of a version mismatch between the application program and the firmware. Therefore, **it is always advisable to update the firmware** (which will imply having the USB option already enabled, if necessary) **prior to updating the application program**.

- The application program and firmware versions must match on the first two digits. An inconsistency between versions does not ensure the correct functioning of the device.

2.1.14.2 LICENCE SETUP

Some of the functionalities available require the installation of a license for their use. If it is not pre-installed, it will be provided by Zennio in a *.lic* file.

Functionality	Licence			
	“Com”	“Remote”	“Zenvoice”	“All”
Video Intercom	✓	✗	✗	✓
Internal Calls	✓	✗	✗	✓
Remote control via IP	✗	✓	✗	✓
Voice control	✗	✗	✓	✓

Table 2. Functionalities associated with licenses

Note: voice control functionality is only available if the device also has remote licence installed.

To install any of the licenses, the *.lic* license files must be included in the root directory of a USB memory or in a folder and/or *.zip* file named *license* and *z_license.zip* respectively.

When the touchscreen recognizes the inserted USB flash drive, a USB icon will appear on the top bar and an informative dialogue will appear on the screen. The actions notified in the message will be, for each of the files with extension *.lic* detected:

- *License Updated:* a new license has been installed.
- *Invalid license found:* a *.lic* file has been detected but the information it contains is not valid.

After installing all the available licenses in the USB memory, a restart will make the licenses effective.

Additionally, licenses can also be installed through a web server utility. The installation process is described in the manual "**Webserver Tools**", available in the product section in Zennio web portal, www.zennio.com.

2.1.14.3 IMPORT AND EXPORT TRANSLATIONS

The translations will be saved in *.xlf files. After a download, the ETS parameterised texts will be the ones in the main language, and it will be overwritten.

Other languages files will have to be generated externally and, afterwards, uploaded to the touchscreen. For this purpose, it will be possible to export and import languages via USB (with the exception of translations from the main language, which shall always correspond to the text of ETS):

- **Export:** it must be created an empty folder named "**lang_export**" on the root directory of a pen drive and connect it to the touchscreen. When the touchscreen detects the inserted USB flash drive, a USB icon appears in the top bar and an information dialog appears on the screen. The action notified in the message will be:
 - *Translations exported:* a copy of all the translation files of the device has been generated in this folder, including the file "*text_dflt.xlf*", which will contain the parameterised texts in ETS.
- **Import:** it must be created another folder named "**lang_import**" containing the files with extension *.xlf of the desired languages to incorporate. The files names should follow the nomenclature "*text_language-region.xlf*", where "*language*" must be the two letters code that correspond to the language and "*locale*" the two letters code associated to the region.

For example, "*text_en-GB.xlf*" would be the language corresponding to English and United Kingdom locale.

A generic translation file can also be generated for a language that is not associated with a particular locale. To do this, it is necessary to follow the nomenclature "*text_language-ZZ.xlf*".

- Once the translations are finished, plug in the USB to the touchscreen and, when it detects the inserted USB flash drive, a USB icon appears in the top bar and an information dialog appears:
 - *New translations imported*: a copy of all translation files stored in the "lang_import" folder has been generated.

Important: *if the language change is done using the 2-byte object, the translation files must follow the nomenclature "text_language-ZZ.xlf". If the 1-byte or 4-byte objects are used for the language change, the translation files must follow the nomenclature "text_language-region.xlf".*

Notes:

- *The finalization of the import and export of the translation files will be notified by a message on the screen.*
- *The USB memories must be formatted in FAT32.*
- *After a download, the *.xlf file for the main language is overwritten, but not for the other languages.*
- *Translations files should not include the characters '<', '>' or '&'. If someone wants to use these characters must use their equivalent valid representation: '<', '>', y '&';, respectively.*
- *The characters that can be displayed on the screen correspond to the alphabets supported by the "[Noto](#)" font.*

For texts translations, it is recommended to use a translation management tool such as OLT (Open Language Tool), to facilitate the translation process with *.xlf files.

2.1.14.4 CUSTOM ICONS

It is possible to import **customised icons** for buttons, boxes or indicators. These icons are parameterised from ETS and will appear with the name "**Cx**" (see sections 2.2.1.3 and 2.2.2.1).

It is necessary to import the icons using a USB with **FAT32 format**. To do this, a folder called "**icons**" must be created in the root directory of the USB, which in turn will have a certain folder structure:

- Custom icons will be differentiated between those generated for the light theme (folder “**light**”) and those generated for the dark theme (folder “**dark**”):

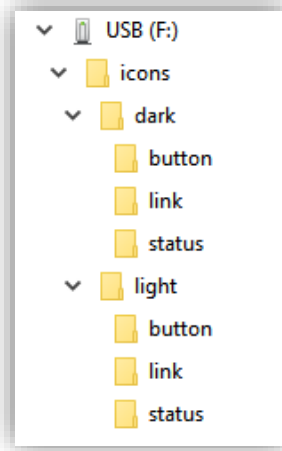

Figure 25. Custom icons (light and dark theme). Root folder structure

This structure will have other folders in which the custom icons will be saved with the name "**custom_icon_1.svg**", "**custom_icon_2.svg**", etc.:

- **Button:** icons for the boxes buttons (maximum 15 customised icons).
- **Link:** icons for direct link boxes or pages (maximum 40 customised icons).
- **Status:** icons for box indicators (maximum 40 customised icons).

Notes:

- *The maximum size of the icons cannot exceed 20KB.*
- *If the name or the format of any of the files is not correct, it will not be imported.*
- *Custom icons do not modify when **Icons type** parameter is set as [Monochromatic]*

After completing the above steps and connecting the USB to the touchscreen, as soon as it identifies the inserted USB flash drive, a USB icon will appear in the top bar and a dialog will inform the user of the action on screen: “New icons imported”.

Recommendations to generate customised icons

When designing and generating custom icons, it is recommended to take into account the following indications to ensure their correct display:

- The viewbox of each of the SVG files should be square (aspect ratio 1:1).

- When exporting the icons:
 - Check the “Convert to outlines” option in the font options.
 - Set the number of decimals to 3.
 - Check the “Responsive” option.

Figure 26 shows an example of the options in *Illustrator*.

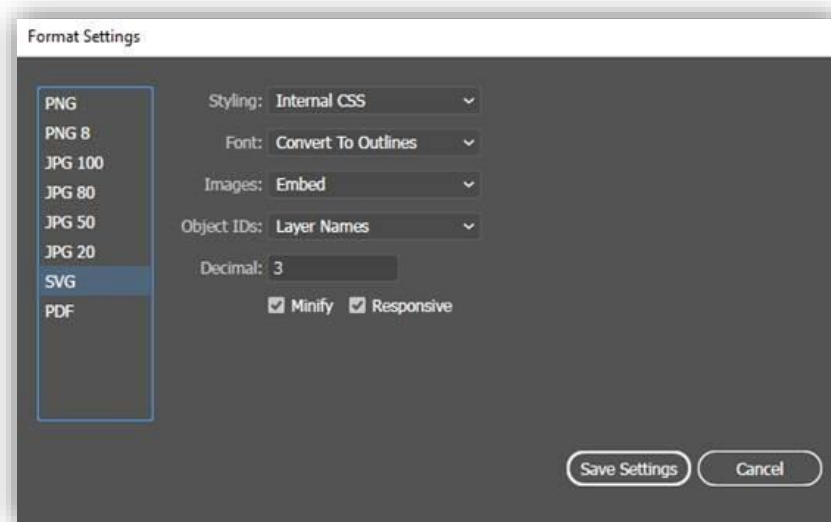

Figure 26. Configuration to export icon in Illustrator

2.1.15 IP CONFIGURATION

Z50 / Z70 v2 / Z100 is able to communicate with other external (**GetFace IP or any other compatible**) or internal (**Z41 COM, Z50, Z70 v2 or Z100**) units via Ethernet connection. Such communications will require correct configuration of certain general IP parameters.

ETS PARAMETERISATION

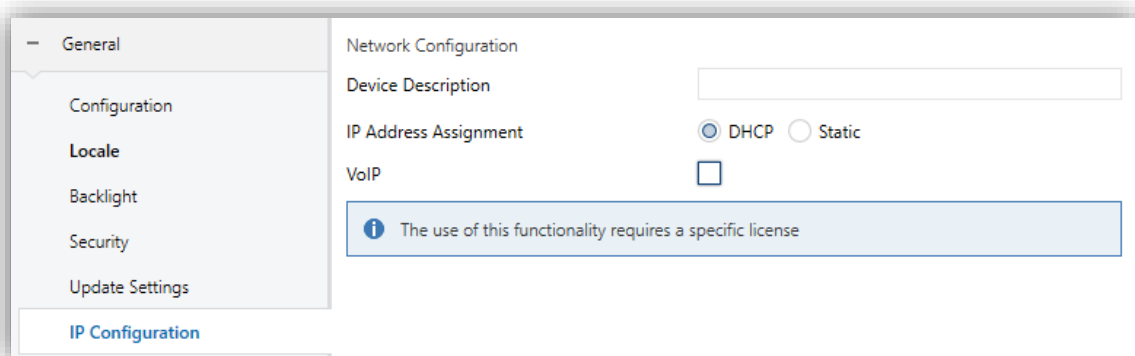

Figure 27. IP Configuration

- **Device Description:** assigns a name to the device.
- **IP Address Assignment** [[DHCP](#) / [Static](#)]: selects whether the IP is set by the DHCP protocol or is defined in a static way. If the [Static](#) option is chosen, the following parameters will be displayed:
 - **IP Address** [[192.168.1.100](#)]: is used to uniquely identify the touchscreen for functionalities such as Webserver, connection to the display via internet, obtaining the time via NTP or VoIP. Therefore, it is the IP address that will be indicated to access Webserver Tools, on the outdoor unit or on a contact of another display to make an internal call.

Note: *it is recommended to set this IP address out of the range of addresses assigned by the home router to prevent possible conflicts with the IP address visible to the internet.*
 - **Subnet Mask** [[255.255.255.0](#)]: must match the mask of the network of the touchscreen belongs to.
 - **Specify Gateway** [[192.168.1.1](#)]: when enabled permits introduce a gateway.
 - **Primary DNS** [[8.8.8.8](#)]: maintains the authoritative information of a domain name, obtained from its own configuration.
 - **Secondary DNS** [[8.8.4.4](#)]: copies its configuration from the primary.

General	Network Configuration
Configuration	Device Description
Locale	IP Address Assignment: Static
Backlight	IP Address: 192.168.1.100
Security	Subnet Mask: 255.255.255.0
Update Settings	Gateway: 192.168.1.1
IP Configuration	Primary DNS: 8.8.8.8
+ VoIP Calls	Secondary DNS: 8.8.4.4
+ Display	VoIP: <input checked="" type="checkbox"/>
	Different Network: <input type="checkbox"/>
	i The use of this functionality requires a specific license

Figure 28. IP Configuration with VoIP enabled on same network

- **VoIP** [[disabled](#) / [enabled](#)]: if enabled, allows communication with external or internal units.

- **Different network** [[disabled](#) / [enabled](#)]: allows to select whether the network for the VoIP functionality is on a different network than the device. When enabled, the following parameters are displayed:
 - **IP Address** [[192.168.1.101](#)].
 - **Subnet Mask** [[255.255.255.0](#)].
 - **Specify Gateway** [[disabled](#) / [enabled](#)]: enabling this allows to enter a gateway [[192.168.1.1](#)]. This only needs to be enabled if the touchscreen is on a different network to the other units it is communicating with.

Note: *If VoIP functionality is enabled, 2 scenarios are possible:*

- **Same network:** *the IP assignment can only be **static**, and the IP will be the same for both the device (the one used for Webserver, remote functionality, or setting the time via NTP), and the VoIP functionality.*
- **Different network:** *the IP assignment for the display can be either DHCP or static:*
 - **DHCP:** *in this case the IP of the display will be assigned via the DHCP protocol, while the IP for the VoIP functionality will be defined by the user statically.*
 - **Static:** *both the IP assignment for the display and for the VoIP functionality will be statically assigned (although they will be different), with the user defining all the parameters.*
- **IP Cameras** [[disabled](#) / [enabled](#)]: if enabled, allows configure IP cameras.

The screenshot displays the 'IP Configuration' settings in the Zennio web interface. The left sidebar shows a navigation menu with 'IP Configuration' selected. The main content area is titled 'Network Configuration' and includes the following fields and options:

- Device Description:** An empty text input field.
- IP Address Assignment:** Radio buttons for 'DHCP' (unselected) and 'Static' (selected).
- IP Address:** Text input field containing '192.168.1.100'.
- Subnet Mask:** Text input field containing '255.255.255.0'.
- Gateway:** Text input field containing '192.168.1.1'.
- Primary DNS:** Text input field containing '8.8.8.8'.
- Secondary DNS:** Text input field containing '8.8.4.4'.
- VoIP:** A checked checkbox.
- Different Network:** A checked checkbox.
- Configuration for VoIP Calls:**
 - IP Address:** Text input field containing '192.168.1.101'.
 - Subnet Mask:** Text input field containing '255.255.255.0'.
 - Specify Gateway:** A checked checkbox.
 - Gateway:** Text input field containing '192.168.1.1'.
- IP Cameras:** An unchecked checkbox.

A blue information banner at the bottom of the configuration area states: 'The use of this functionality requires a specific licence'.

Figure 29. IP Configuration with VoIP enabled on different network

2.1.16 VOIP CALLS (LICENSE REQUIRED)

Note: VoIP calls functionality requires a license installation. If not, even being possible to configure it from ETS, its use will not be accessible.

Z50 / Z70 v2 / Z100 can receive, over its Ethernet connection, voice and video calls from:

- A Zennio **indoor unit: Z41 COM, Z50, Z70 v2 or Z100**. These calls are referred in this document as **internal calls**.
- A Zennio **outdoor unit (GetFace IP)** or any video intercom compatible. These calls are referred in this document as **video intercom calls**.

In case the same outdoor unit calls more than one indoor units at the same time, they must be **synchronized** and connected to **the same network**. The synchronization will allow actions performed on one of the screens to be notified to the others.

ETS PARAMETERISATION

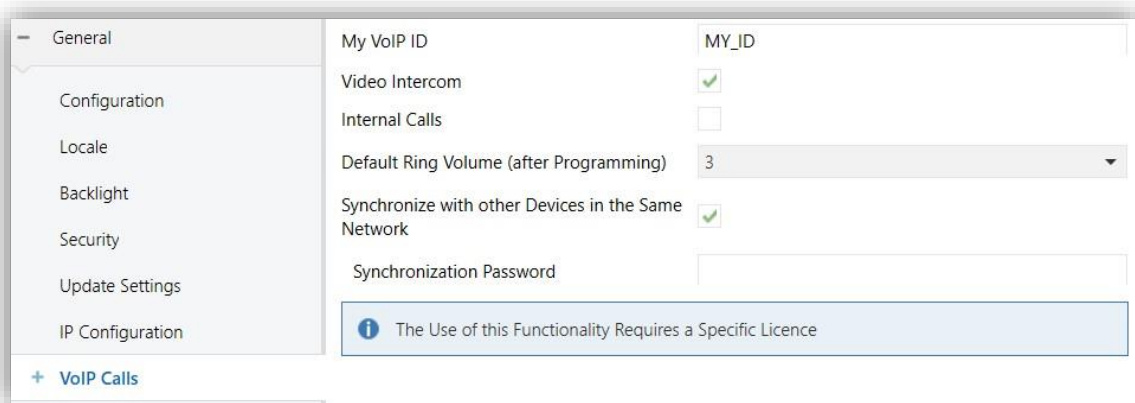

Figure 30. VoIP Calls

- **My ID** [[MY_ID](#)]: identification code of the Z50 / Z70 v2 / Z100 required to communicate with other devices.

Note: the characters included in this field must comply RFC 2396 standard.

- **Video Intercom** [[disabled](#) / [enabled](#)]: enables or disables “Video Intercom” tab for the configuration of external video intercom. See section 2.1.16.1 for more details.
- **Internal Calls** [[disabled](#) / [enabled](#)]: enables or disables “Internal Call” tab for the configuration of internal calls to other devices. See section 2.1.16.2 for more details.

If any of the above parameters are enabled, the following will appear:

- **Default Ring Volume (after Programming)** [[No sound](#) / [1](#) / [2](#) / [3](#) / [4](#) / [5](#)]: define the VoIP calls volume after Programming.
- **Synchronize with other Devices in the Same Network** [[disabled](#) / [enabled](#)]: enables the device to share the call status and history with all other units connected to the same network that have this functionality enabled. Then the following parameter will also appear:

- **Synchronization Password:** field that must match in all the devices to synchronise.

Note: synchronisation with other devices is available for Z50, Z70 v2 and Z100. If there is a Z41 COM in a system, synchronisation will not be performed.

In addition, when the parameters **Video Intercom** and/or **Internal Calls** are enabled, the following objects will appear:

- “[VoIP] Ringtone Volume”: object to change the volume of the incoming calls ringtone.
- “[VoIP] Video Intercom Ringtone” or “[VoIP] Internal Call Ringtone”: 1-byte object to change the video intercom or internal call ringtone.
- “[VoIP] Play Video Intercom Ringtone”: 1-bit object that plays the video intercom ringtone once.
- “[VoIP] “Do Not Disturb” Mode”: 1-bit object that enables and disables the do not disturb mode. While this mode is active, the touchscreen will not receive any incoming calls, but the calls will be recorded in the log.
- “[VoIP] Active Call”: this object is sent to the bus (with value ‘1’) when a call starts and (with value ‘0’) ends, indicating whether the call is active or not. The purpose of this object is, for example, to be able to mute a stereo during a call and have the sound resumed at the end of the call.

2.1.16.1 VIDEO INTERCOM (LICENSE REQUIRED)

Note: *Video Intercom functionality requires a license installation. If not, even being possible to configure it from ETS, its use will not be accessible.*

The touchscreen will be able to receive calls and show images from the camera of a Zennio outdoor unit (**GetFace IP**) or any other compatible (**Comelit, Doorbird, Fermanx, Akuvox or a custom** outdoor unit). Moreover, the door can be opened and a common call log is available for all configured video intercom.

Note: *to access the call log and visualization of the image of the camera is required necessary to parameterise a box as a Video Intercom. For further information see section 2.2.2.1.5.5.*

Up to 21 outdoor units can be enabled, one of them being generic. Each outdoor unit can parameterize up to 4 doors, for a total of 84 doors controllable. The GetFace IP, or the used video intercom, is responsible for controlling the power supply to the doors locks.

Meanwhile, each GetFace IP can call to a maximum of 10 indoor units in parallel.

The ETS configuration includes some predefined profiles that facilitate the configuration of the video intercom model used. It is also possible to make a complete configuration with the **Custom** profile (see section 2.1.16.1.1).

The following table shows the configuration of each of the available profiles:

Profile	Incoming call preview	Camera visualization	Call log snapshot	Door opening
Zennio	HTTP	HTTP	HTTP	HTTP with optional authentication
Comelit	SIP	Auto-answer	Screenshot	DTMF
Doorbird	HTTP with authentication	HTTP with authentication	HTTP with authentication	HTTP with authentication
Fermax	SIP	Auto-answer	Screenshot	SIP
Akuvox	HTTP with optional authentication	HTTP with optional authentication	HTTP with optional authentication	HTTP with optional authentication

Table 3. Video intercom profiles internal setting

In addition, in ANNEX I. Video Intercom Operation, the functions and controls of the different dialogues that appear related to the video intercom functionalities are detailed.

For further information about the configuration of Z50 / Z70 v2 / Z100 and external units GetFace IP, please refer to the "**GetFace IP Configuration Guide with Indoor Units**" and the specific documentation of "**Zennio GetFace IP**" (available at www.zennio.com).

For further information about the configuration of Z50 / Z70 v2 / Z100 and external units of different brands (Comelit, Fermax, Doorbird and Akuvox), please refer to the "**Video Intercom Configuration Guide with Predefined Profiles and Indoor Units**" (available at www.zennio.com).

ETS PARAMETERISATION

After enabling **Video Intercom** in the “VoIP Calls” screen (section 2.1.16), a new tab will be incorporated into the tree on the left.

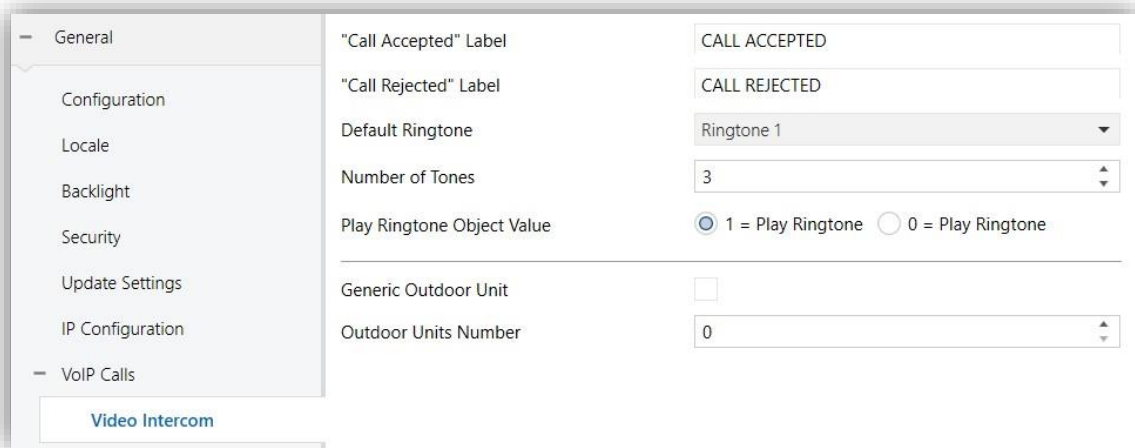

Figure 31. Video Intercom

- **“Call Accepted” Label** [[CALL ACCEPTED](#)]: text to be displayed when the call is accepted on a synchronised device.
- **“Call Rejected” Label** [[CALL REJECTED](#)]: text to be displayed when the call is rejected on a synchronised device.
- **Default Ringtone** [[Ringtone 1 / ... / Ringtone 7](#)]: melody played by the touchscreen when receiving a call from an video intercom. The tone can be changed from the configuration page (see section 2.2.1.2.3) or through the “[VoIP] Video Intercom Ringtone” object.
- **Numer of Tones** [[0...3...10](#)]: set how many times will sound the ringtone.
- **Play Ringtone Object Value** [[1 = Play Ringtone / 0 = Play Ringtone](#)]: define the polarity of “[VoIP] Play Video Intercom Ringtone” object.
- **Generic Outdoor Unit** [[disabled / enabled](#)]: checkbox that enables a new tab with the same name in the left menu where the generic outdoor unit is configured (see section 2.1.16.1.2).
- **Outdoor Units Number** [[0...20](#)]: enables the chosen number of new tabs where each video intercom is configured (see section 2.1.16.1.1).

2.1.16.1.1 Outdoor Unit N

The video intercom used can be of two types: **private** or **community**. The main difference between them is that **community** video intercom does not enable the camera image to be viewed if there is no incoming or ongoing call. In case the unit does not have a camera, the images will not be viewed in case of any event, no matter what type of video door phone it is.

Each outdoor unit enables the setting of up to 4 doors, whose opening can be executed by means of an **HTTP command** (it is possible to enable secure opening with username and password) sent to the outdoor unit and/or a **communication object** sent directly to the actuator.

It is also possible to enable the sending of a KNX object to the bus each time the door is opened.

ETS PARAMETERISATION

After enabling any of the **outdoor units** (see section 2.1.16.1), a new sub-tab "N Outdoor Unit" is displayed.

Figure 32. N Outdoor Unit

- **Name:** text field identifying the outdoor unit. This name will be displayed both in the call log and on the top bar of incoming and ongoing calls. If **Different Name for ETS** [*disabled / enabled*] is enabled a text field **ETS Name** appears which

allows displaying different names for the same outdoor unit in ETS and in the touchscreen.

- **Type** [[Private](#) / [Community](#)]: The [Private](#) type enables access at any time to the visualization of images from the camera of the outdoor unit.
- **Profile** [[Zennio](#) / [Comelit](#) / [Doorbird](#) / [Fermax](#) / [Akuvox](#) / [Custom](#)]: parameter to select predefined configuration for some video intercom models. Depending on the chosen profile, certain configurable parameters are shown. In the case of the [Custom](#) profile all parameters are shown.

Figure 33. Custom profile main setting

- **Unit with Camera** [[disabled](#) / [enabled](#)]: define whether the video intercom has camera.
- **Outdoor Unit ID**: outdoor unit alphanumerical identifier.
Note: *the characters included in this field must comply RFC 2396 standard.*
- **Set Static IP** [[disabled](#) / [enabled](#)]: if the touchscreen and the outdoor unit are in different networks, the **IP Address** [[0.0.0.0](#)] of the video intercom must be indicate, in addition to **Specifying Gateway**, in “IP Configuration” tab (see section 2.1.15).
➤ **Set Port** [[disabled](#) / [enabled](#)]: if enabled, the parameter **Port** [[5060](#)] will then be displayed to define the port of the video intercom used for communication. Together with this parameter, the **SIP URI** of the video intercom will be displayed.

If a video intercom with Comelit profile is being configured, the following parameter will appear:

- **Line number [1/.../1000]:** this parameter corresponds to the line where the video intercom has been configured in the "VIP to Sip lines" section of the Comelit gateway.

VIP to Sip lines						
	Reserved	VP address	VP subaddress	User	Access code	User ID
→ 1	True	00000101	Whole apartment	PLACA1		
2	True	00000100	Whole apartment	PLACA2		
*						

Figure 34. Comelit gateway configuration

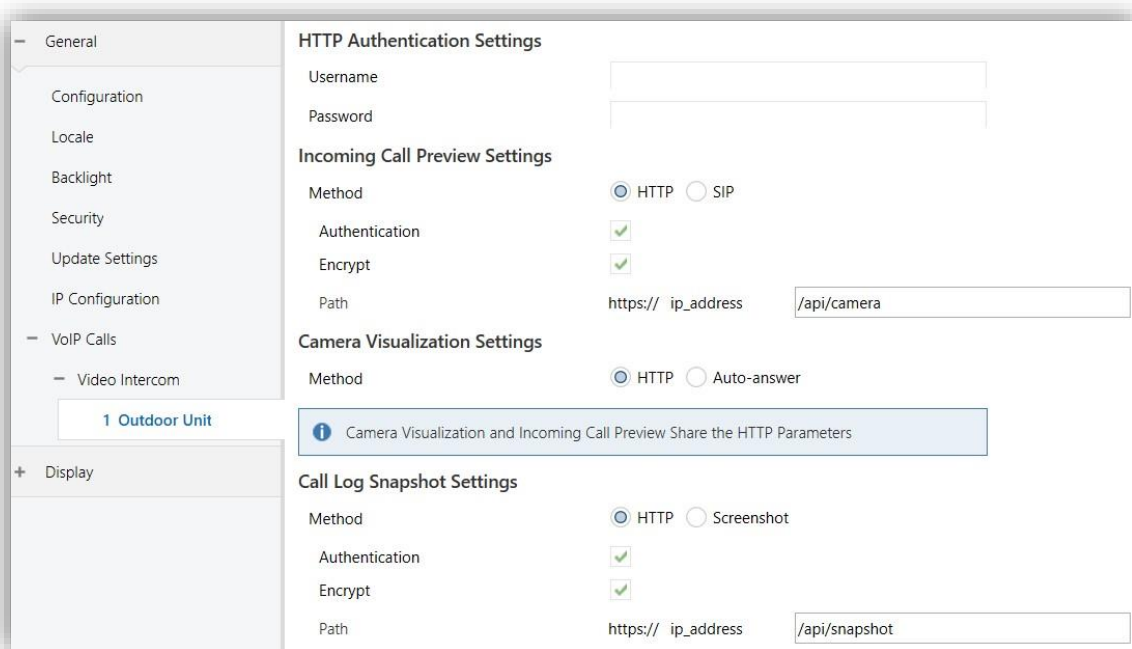

Figure 35. Incoming call preview, camera visualization and call log snapshot settings

- **HTTP Authentication Settings:** it is displayed if HTTP method with authentication has been selected in any of the next configurations.
 - **Username:** must match the username set in the video intercom HTTP authentication settings.
 - **Password:** must match the password set in the video intercom HTTP authentication settings.
- **Incoming Call Preview Settings:**

- **Method** [HTTP / SIP]: communication method used between the touchscreen and the video intercom for incoming call preview. If HTTP is chosen, the following parameters are displayed:
 - **Authentication** [disabled / enabled]: determines whether authentication is required for the incoming call preview.
 - **Encryption** [disabled / enabled]: determines whether the HTTP command uses security (https).
 - **Path** [/api/camera]: path for incoming call preview.
- **Camera Visualization Settings:**
 - **Method** [HTTP / Auto-answer]: communication method used between the touchscreen and the video intercom for camera visualization. If HTTP is chosen, the parameters are shared with the incoming call preview settings.
- **Call Log Snapshot Settings:**
 - **Method** [HTTP / Screenshot]: method used to set the photo in the call log. If HTTP is chosen, the 3 additional parameters explained in the **Incoming Call Preview Settings** section will be displayed.

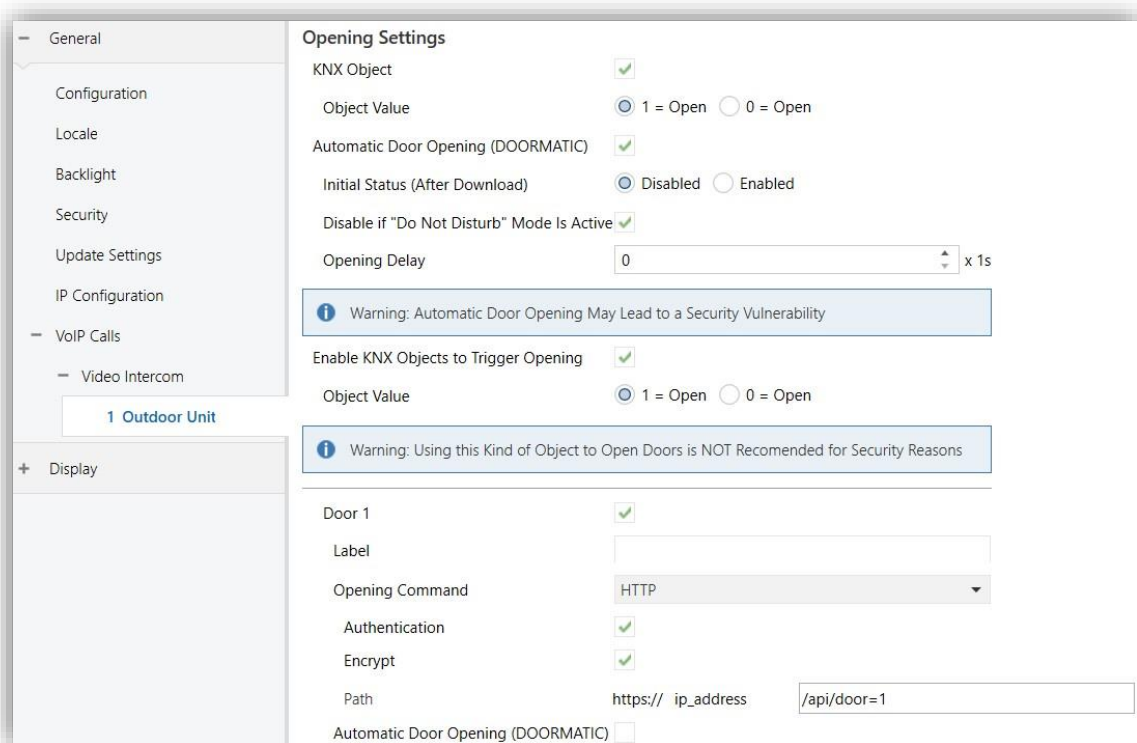

Figure 36. Opening settings

● Opening Settings:

- **KNX Object** [[disabled](#) / [enabled](#)]: enables the 1-bit object “[VI n] Switch n” which is sent to the bus each time the door is opened. This object could control the output of a KNX actuator connected to the lock. It is possible to choose the **Object Value** [[1 = Open](#) / [0 = Open](#)] to open the door.
- **Automatic Door Opening (DOORMATIC)** [[disabled](#) / [enabled](#)]: allows the door(s) to be opened automatically when a call is received. When enabled, the following parameters are displayed:
 - **Initial Status (After Download)** [[disabled](#) / [enabled](#)]: sets whether the automatic opening is enabled or not after ETS Download. It also can be changed at runtime through the object “[VI n] Enable Automatic Door Opening”.
 - **Disable if “Do Not Disturb” Mode Is Active** [[disabled](#) / [enabled](#)]: disables the automatic door opening when do not disturb mode is active.
 - **Opening Delay** [[0...255](#)] [[x 1s](#)]: sets a time after which the automatic door opening command will be sent.
- **Enable KNX Objects to Trigger Opening** [[disabled](#) / [enabled](#)]: enables the 1-bit object “[VI n] Trigger Switch n” which can open the door by writing on the KNX object. It is possible to choose the **Object Value** [[1 = Open](#) / [0 = Open](#)] to open the door.

Important: *For safety reasons, it is recommended to use an opening command to open the door instead of the communication object. If this object is used, it shall be under the responsibility of the integrator.*

- **Door n** [[disabled](#) / [enabled](#)]: enables or disables every door, up to 4 for each outdoor unit.
 - **Label:** name that will appear on the preview, incoming call and ongoing call panel to identify the door.
 - **Opening Command** [[Disabled](#) / [HTTP](#) / [DTMF](#)]: sets the opening command used. If [HTTP](#) chosen, the following parameters are displayed:
 - **Authentication** [[disabled](#) / [enabled](#)]: determines whether authentication is required to perform the door opening.

- **Encryption** [*disabled* / *enabled*]: determines whether the HTTP command uses security (https).
- **Path** [*/api/door=N*]: path used to perform the door opening, being *N* the door number.

If *DTMF* chosen as opening command, the following parameter is displayed:

- **DTMF Code** [*1234*]: DTMF (RTP – RFC2833) code used to perform the door opening.
- **Automatic Door Opening (DOORMATIC)** [*disabled* / *enabled*]: defines whether each of the doors should open automatically with the set delay. It can be enabled whenever the general parameter for **automatic door opening** of the outdoor unit is enabled.

For further information about the configuration above parameters of external units please refer to the specific manual of each video intercom. For GetFace IP refer to “**GetFace IP Configuration Guide with Indoor Units**” and the specific documentation of “**Zennio GetFace IP**” (available at www.zennio.com).

2.1.16.1.2 General Outdoor Unit

Whenever a call is received from a video intercom whose identification code (ID) does not match any of the parameterized ones for the rest of the enabled outdoor units (see **outdoor unit ID**, section 2.1.16.1.1), the call will be visualized on the generic outdoor unit panel.

ETS PARAMETERISATION

After enabling **Generic Outdoor Unit**, in “Video Intercom” (see section 2.1.16.1), a new tab with the same name is created:

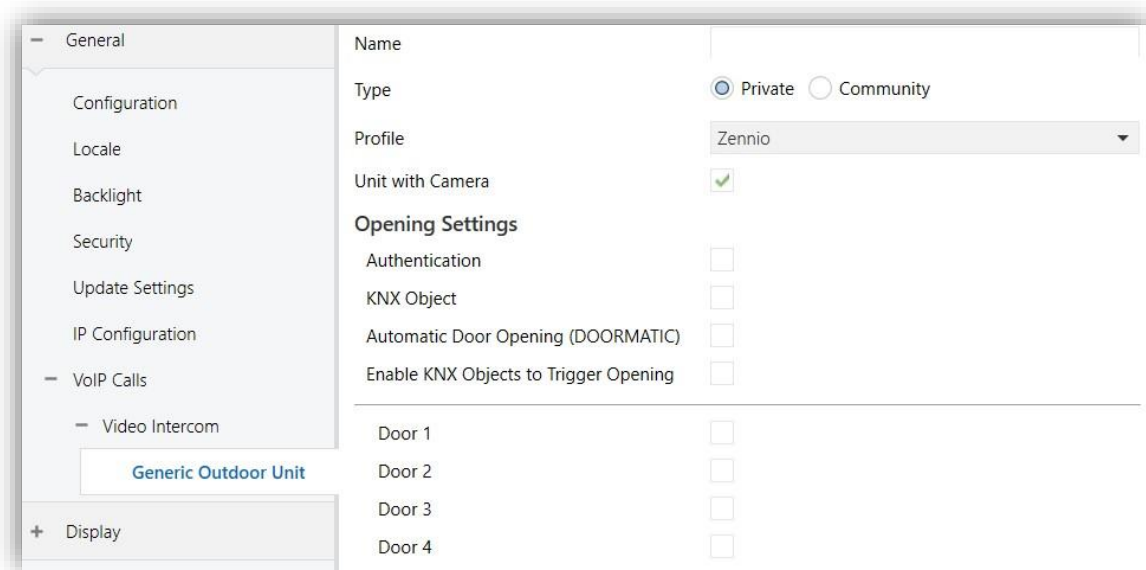

Figure 37. Generic Outdoor Unit

This tab is analogous to "Outdoor Unit N", but the video intercom identification fields (**Outdoor unit ID** and **Set Static IP**) are excluded.

For more information on the configuration of the parameters see section 2.1.16.1.1.

2.1.16.2 INTERNAL CALL (LICENSE REQUIRED)

Note: *Internal Call functionality requires a license installation. If not, even being possible to configure it from ETS, its use will not be accessible.*

Z50 / Z70 v2 / Z100 can, via its Ethernet connection, make and receive calls from others indoor unites and that will be registered. The access to the internal call history will be enabled as long as, at least one box is configured as an internal call (see section 2.2.2.1.5.6).

To receive calls, each of the screens involved in the communication must have the other configured as a contact. Up to 8 contacts can enable and configure or be imported up to 100 via web.

For further information about the configuration and importation of contacts via web, please refer to the "**Webserver Tools**" manual (available in the product section in Zennio web portal, www.zennio.com).

In ANNEX II. Internal Call Operation details the functions and controls of the dialogs related to the internal calls functionalities.

ETS PARAMETERISATION

After enabling **Internal Calls**, in “VoIP Calls” tab (section 2.1.16), a new tab will be incorporated into the tab tree:

Page Title: Incoming Call	Incoming Call
Page Title: Outgoing Call	Outgoing Call
Page Title: Ongoing Call	Ongoing Call
"Communication Error" Label	COMMUNICATION ERROR
"End Call" Label	END CALL
"Busy Contact" Label	BUSY CONTACT
Default Ringtone	Ringtone 1
Number of Tones	3
Import Contacts	<input checked="" type="radio"/> From ETS <input type="radio"/> From the Web
Contact 1	<input type="checkbox"/>
Contact 2	<input type="checkbox"/>
Contact 3	<input type="checkbox"/>
Contact 4	<input type="checkbox"/>
Contact 5	<input type="checkbox"/>

Figure 38. “Internal call” tab

- **Page Title: Incoming / Outgoing / Ongoing Call:** titles of the different dialogues of the internal calls.
- **“Communication Error” / “End Call” / “Busy Contact” Label:** text displayed on screen when a call cannot be established with the contact, the call is terminated or the contact has an ongoing call, respectively.
- **Default Ringtone** [[Tone 1](#) / ... / [Tone 7](#)]: selects the sound that the touchscreen will make when it receives an internal call from another device. The selected tone will be applied after downloading but can be changed later from the configuration page (see section 2.2.1.2.3) or by communication object.
- **Number of Tones** [[0](#) / ... / [3](#) / ... / [10](#)]: sets how many times the ringtone will sound.
- **Import Contacts** [[From ETS](#) / [From the Web](#)]: defines how the contacts list will be imported. If the **“From ETS”** option is chosen, the following parameters will also be displayed:

- **Contact n** [[disabled](#) / [enabled](#)]: checkbox enabling a new tab ("Contact n") where the parameters of each indoor unit are configured (see section 2.1.16.2.1).

Note: For further information about the configuration and importation of contacts via web, please refer to the “**Webserver Tools**” manual (available in the product section in Zennio web portal, www.zennio.com).

2.1.16.2.1 Contact n

ETS will enable to configure a list of up to 8 contacts for each touchscreen.

To be able to make calls to other screens, it is necessary to configure certain parameters such as the ID and IP address of each contact.

ETS PARAMETERISATION

After enabling **Contact n** in “Internal Call” subtab, a new tab is created where the name of the contact that is going to appear in the touchscreen and the necessary data to be able to establish communication with other devices is possible to set.

Figure 39. "Contact n" tab

This tab shows the following parameters:

- **Name** [[Contact n](#)]: This name will be displayed both in the call log and on the top bar of incoming and ongoing calls.

If **Different Name for ETS** [[disabled](#) / [enabled](#)] is enabled a text field **ETS Name** appears which allows displaying different names for the same outdoor unit in ETS and in the touchscreen.

- **ID** [[IC_n](#)]: Contact identifier.
- **IP Address** [[192.168.1.111](#)]: IP address of the contact.

Important: both the IP address and ID must match the **IP Address** and **My ID** set in the "IP Settings" tab (section 2.1.15) of the device to which the contact refers.

2.1.17 IP CAMERAS

Z50 / Z70 v2 / Z100 offers the possibility to display a panel where to navigate between the different enabled IP cameras (up to a maximum of 10 cameras).

This functionality is compatible with IP cameras using **HTTP** and **RTSP** protocol, and **MJPEG** and **H.264** video codec.

The panel displays the name of the camera and navigation buttons at the top, on the left side the video and on the right side a button with binary or scene control functionality can be enabled.

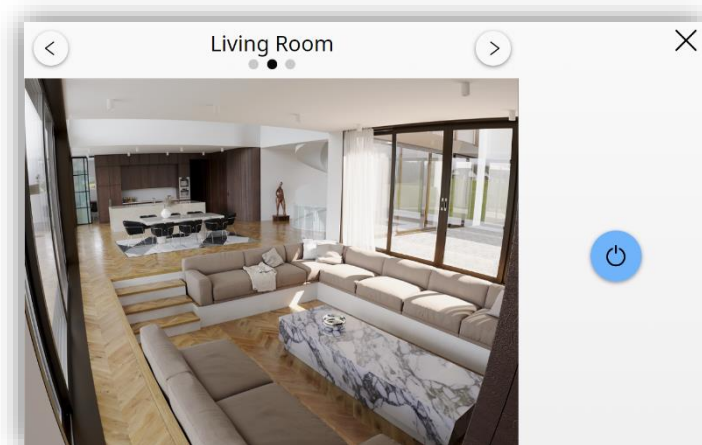

Figure 40. IP Cameras panel

Note: to access the IP camera is required necessary to parameterise a box as an IP camera (see section 2.2.2.1.5.12).

The configuration of the IP cameras can be done from ETS or the Webserver Tools. For further information, please refer to the "**Webserver Tools**" manual (available in the product section in Zennio web portal, www.zennio.com).

ETS PARAMETERISATION

The following parameter is displayed in the IP cameras tab:

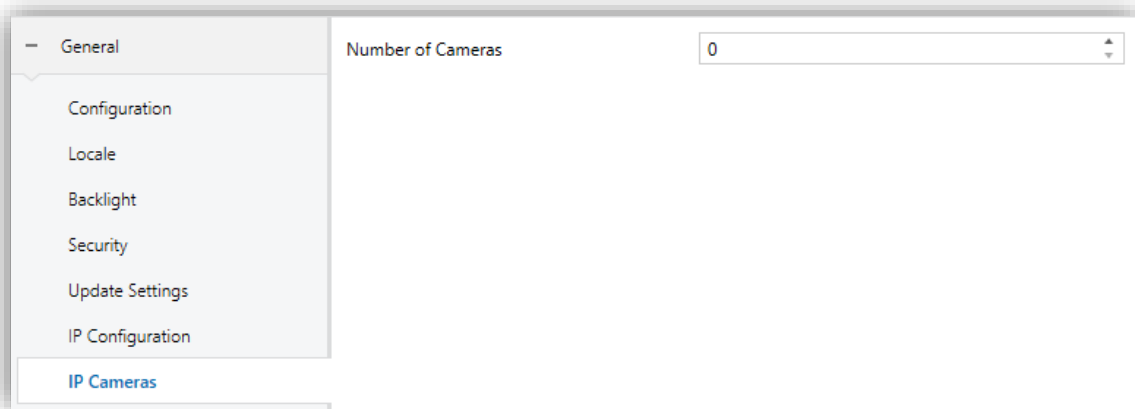

Figure 41. Number of IP cameras parameterisation

- **Number of Cameras** [0 / ... / 10]: sets the number of enabled cameras.

2.1.17.1 CAMERA N

For each enabled camera a new tab will be displayed with the following parameters:

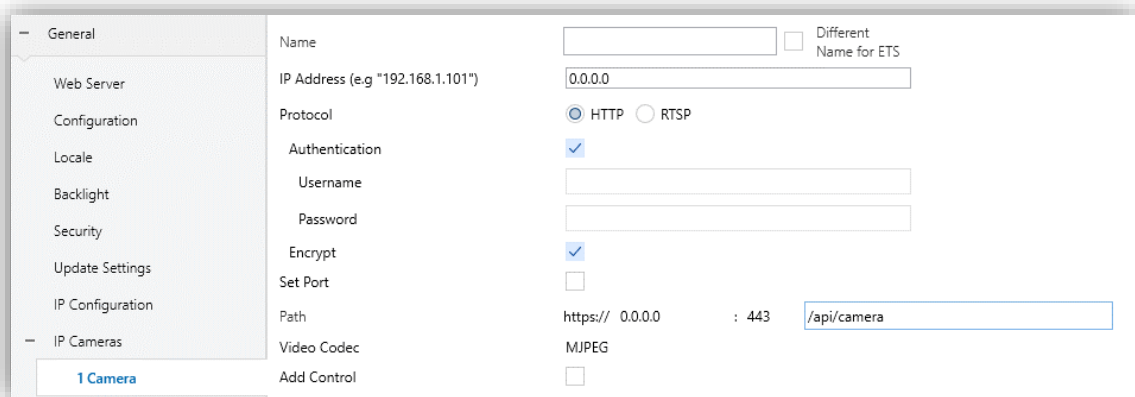

Figure 42. IP Camera parameterisation

- **Name**: text displayed on the panel of the IP camera.
- **IP Address** [0.0.0.0]: IP address of the camera. It is recommended to configure the camera with a static IP address.
- **Protocol** [HTTP / RTSP]: sets the communication protocol with the IP camera.

- **Authentication** [*disabled* / *enabled*]: determines whether authentication is necessary when communicating with the IP camera.
 - **Username:** this text field must match the username defined in the IP camera authentication settings.
 - **Password:** this text field must match the password defined in the IP camera authentication settings.
- **Encrypt** [*disabled* / *enabled*]: this parameter is only available if communication with HTTP protocol has been configured. If it is enabled, communication will be done using the secure transfer protocol (*https*).
- **Set Port** [*disabled* / *enabled*]: if enabled, the parameter **Port** [1024] will then be displayed to define the port of the IP Camera.

Note: *it is only necessary to define the port in case the IP camera does not use the default port for the configured protocol.*

- **Path** [/api/camera]: path through which the video will be requested to the IP camera. It contains the chosen communication protocol, the IP address and the port to be used. Next to this, a text box appears where the rest of the path must be included, which will depend on the IP camera used.
- **Video Codec** [MJPEG / H.264]: video codec used by the IP camera. If the HTTP protocol has been selected, only the MJPEG option can be selected.
- **Add Control** [*disabled* / *enabled*]: enables a control for the IP camera. If enabled, the following parameters are displayed:

- **Object Type** [Binary / Scene]: defines the type of control.

If Binary option is chosen, the following parameter will be displayed:

- **Action** [Send 0 / Send 1 / Toggle 0/1]: specifies what value will be sent to the bus through the object “[Camera n] Switch – Control “0/1”” after pressing the control.

If Scene option is chosen, the following parameters will appear:

- **Scene Number** [1 / ... / 64]: scene value to be sent.
- **Object to Use** [General Scene Object / Individual Camera Scene Object]: specifies whether the scene value will be sent through the object

"[General] Scenes: Send" or through the individual object "[Camera n] Scene – Send Scene Control".

- **Button:** drop-down list with the available icons to show in the button.

2.1.18 AVANCED

Independent tab for the parameterisation of some advanced functions. These functions are explained next.

ETS PARAMETERISATION

After enabling the **Advanced Configuration** from “Configuration” screen (see section 2.1.2), a new tab will be incorporated into the tree on the left.

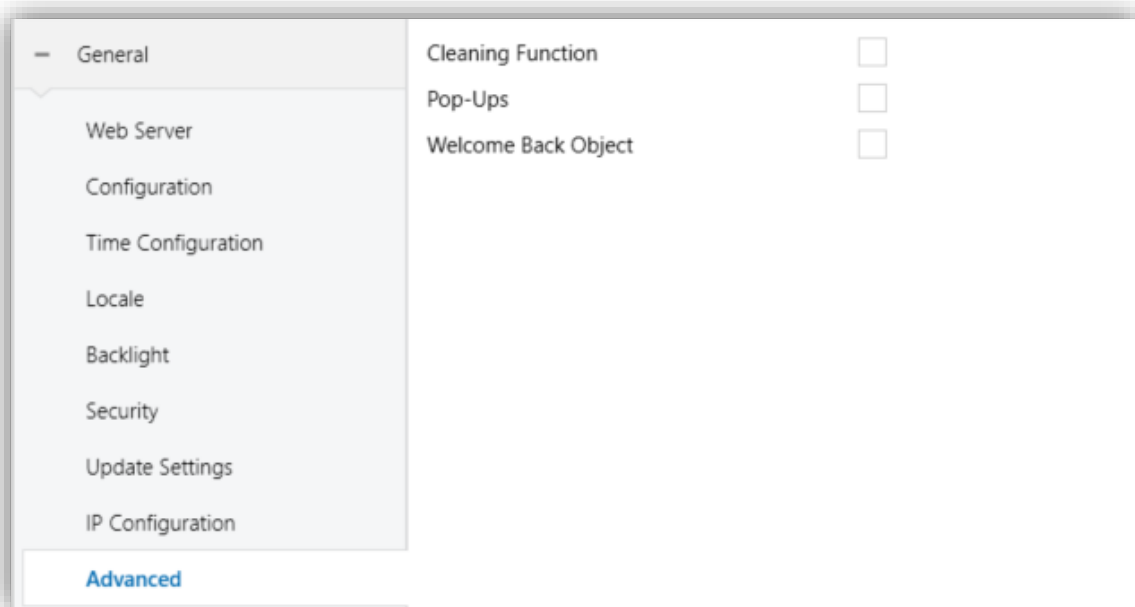

Figure 43. Advanced Configuration

- **Cleaning Function** [*disabled* / *enabled*]: enables or disables the “Cleaning Function” tab. See section 2.1.18.1 for details.
- **Pop-Ups** [*disabled* / *enabled*]: enables or disables the “Pop-Ups” tab. See section 2.1.18.2 for details.
- **Welcome Back Object** [*disabled* / *enabled*]: enables or disables the “Welcome Back Object” tab. See section 2.1.18.3 for details.

2.1.18.1 CLEANING FUNCTION

This feature is very similar to the touch locking, that is, it locks the touch area, thus discarding further button touches. The difference is that this function remains active only during a parameterisable time, and then stops.

This function is intended to let the user clean the touch area with the certainty of not triggering unwanted actions.

A message is shown during the cleaning state. When the timeout is about to end, making this message blink or the device beep (or both) is possible too.



Figure 44. Cleaning Function Message

ETS PARAMETERISATION

After enabling **Cleaning Function** from “Advanced” screen (see section 2.1.17), a new tab will be incorporated into the tree on the left.

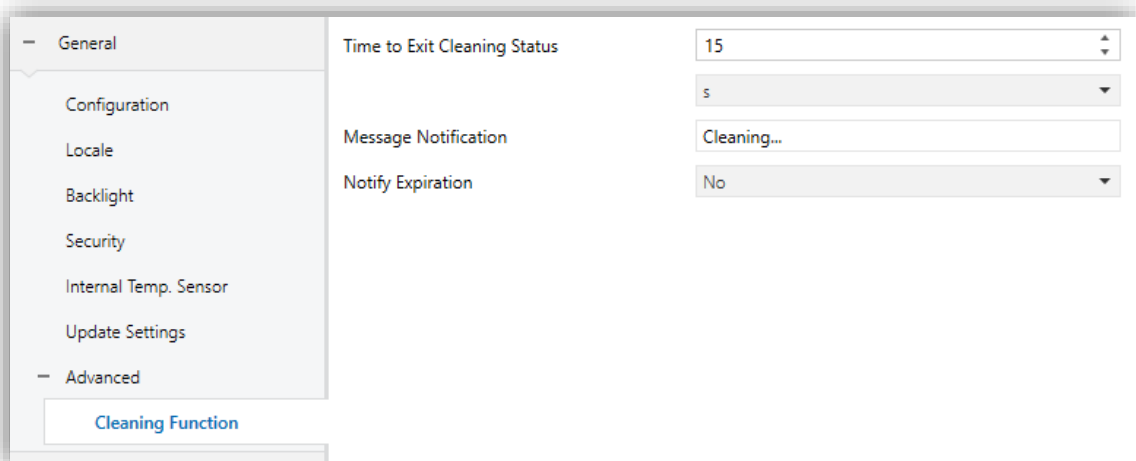

Figure 45. Cleaning Function

- **Time to Exit Cleaning Status** [5...15...65535] [s] [1...65535] [min / h]: timeout to deactivate the cleaning function after triggered.

- **Message Notification** [[Cleaning...](#)]: textbox to enter the desired message.
- **Notify Expiration** [[No](#) / [Blink Message](#) / [Play Sound](#) / [Both](#)]: sets whether to notify the timeout expiration or not. When any of the three later options is selected, a new parameter shows up:
 - **Length of the Warning** [[1...5...65535](#)] [[s](#)] [[1...65535](#)] [[min](#) / [h](#)]: sets the ahead-time to start the notification prior to the end of the cleaning function.

The “[**General**] **Cleaning Function**” one-bit object triggers the cleaning function when it receives a “1” from the KNX bus.

2.1.18.2 POP-UPS

This function permits showing the user a **pop-up message** of up to four lines of text on the display, each of which can be object-dependant or set in parameters.

It is possible to enable up to 6 pop-ups, each of which can be launched in 3 different ways: by using a 1-bit object, by using a 1-byte object or by modifying the text of one of the messages. They can also be launched when activating the different states of the control of Room State (see section 2.2.2.1.2.6).

The pop-up can be closed pressing the confirmation button inside it or using the 1-bit or 1-byte objects named above.

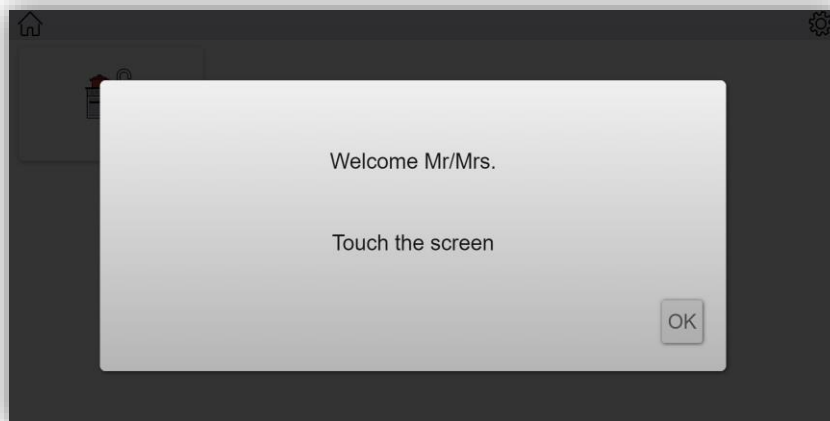

Figure 46. Pop-up

ETS PARAMETERISATION

After enabling **Pop-Ups** from “Advanced” screen (see section 2.1.17), a new tab will be incorporated into the tree on the left.

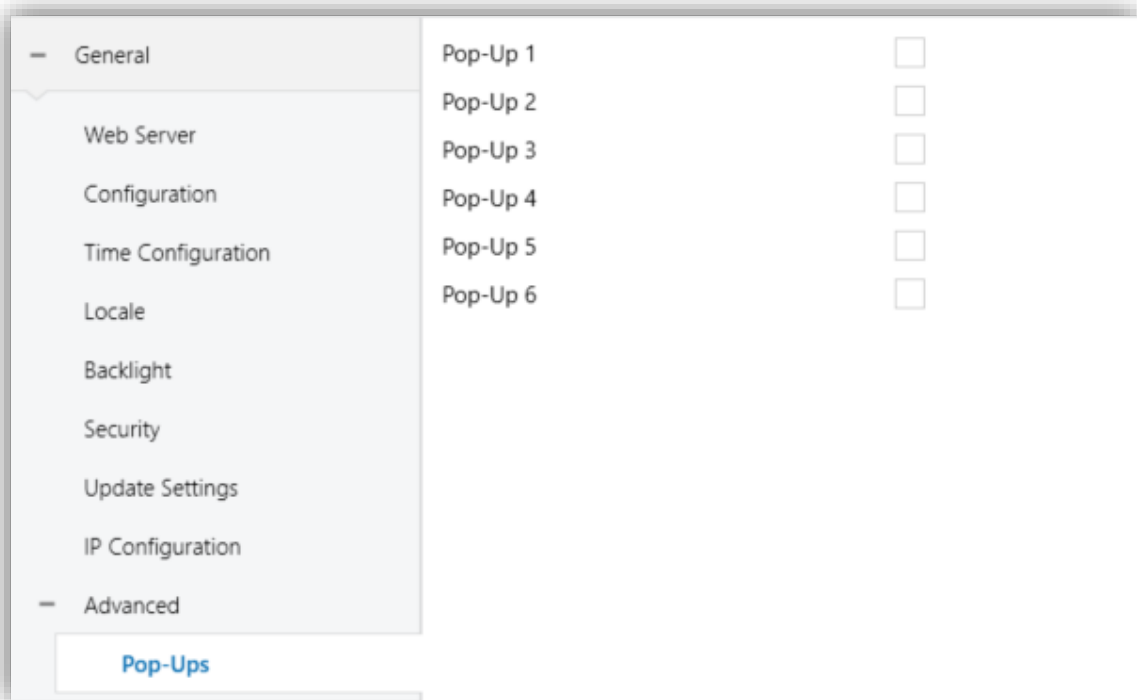

Figure 47. Pop-ups tab

- **Pop-Up n** [*disabled/enabled*]: allows to enable/disable each pop-up. After enabling each pop-up, a new tab will be incorporated into the tree on the left named “Pop-Up n”.

2.1.18.2.1 Pop-Up n

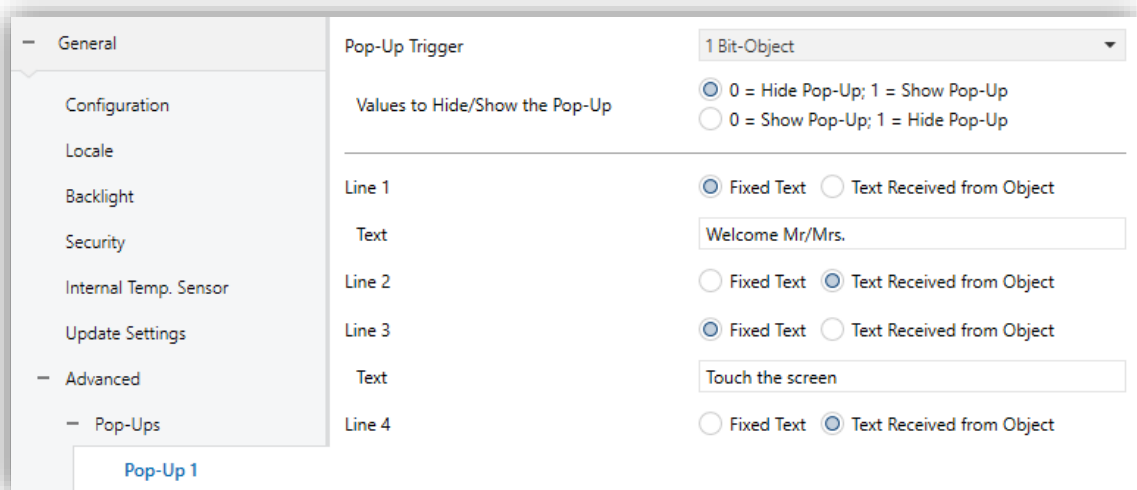

Figure 48. Pop-Up n

- **Pop-Up Trigger**: sets the type of object that is used to show the pop-up message.

- [\[1 Bit Object\]](#): when this option is selected, the object “[General][Pop-Up n] 1 Bit” appears to launch the pop-up message.
 - **Values to Hide/Show the Pop-Up** [[0 = Hide Pop-Up; 1 = Shown Pop-Up](#) / [0 = Shown Pop-Up; 1 = Hide Pop-Up](#)]: allows to choose the polarity of the 1-bit object to show/hide pop-up.
- [\[1 Byte Object\]](#): allows to show/hide the pop-up through the object “[General][Pop-Up n] 1 Byte”. When selected, the following parameters are displayed:
 - **Object Value to Hide Pop-Up** [[0...255](#)]: sets the value used to hide the pop-up.
 - **Object Value to Show Pop-Up** [[0...255](#)]: sets the value used to show the pop-up.

Note: *If the value to hide the pop-up is the same as the value to show it, it won't be hidden with any value.*
- [\[Changes in 14 Bytes Objects\]](#): when this option is selected, the pop-up will appear on the screen when a value is received through the objects “[General][Pop-Up n] Line x”.
 - **Line [1,4]** [[Fixed Text](#) / [Text Received from Object](#)]: sets whether the corresponding text line will be pre-defined or object-dependent. If “[Fixed Text](#)” is selected, the following parameter will appear
 - **Text:** textbox to enter the desired text for the corresponding line.

The 14-byte object “[General][Pop-Up n] Line x” will be shown up to four times per pop-up, depending on how many text lines have been assigned the option “[Text Received from Object](#)”.

2.1.18.3 WELCOME BACK OBJECT

Z50 / Z70 v2 / Z100 can send a specific object to the KNX bus when the user presses a touch button after a significant amount of time since the last press or presence detection (when the proximity sensor is enabled). Sending it or not can also depend on **an additional, configurable condition** consisting in the evaluation of up to five binary objects.

Any actions that in normal operation may be executed will not be if the welcome back object is sent to the bus. Thus, if the user presses a button and this causes the welcome back object to be sent, the normal action of that button will not be triggered.

ETS PARAMETERISATION

After enabling **Welcome Back Object** from “Advanced” screen (see section 2.1.18), a new tab will be incorporated into the tree on the left.

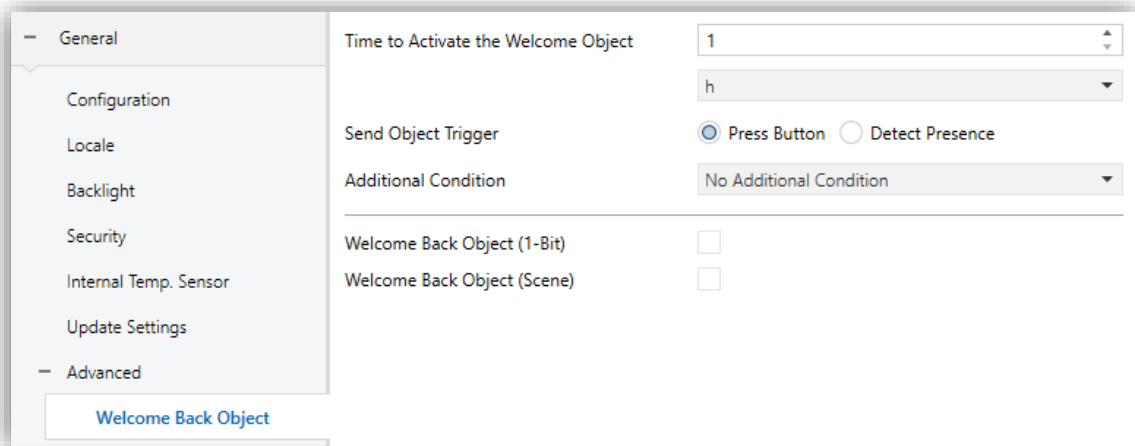

Figure 49. Welcome Back Object

- **Time to Activate the Welcome Object** [30...65535] [s] [1...65535] [min/h]: sets the minimum time that should elapse after the last button touch (or presence detection, when the proximity sensor is enabled) before the next one triggers the execution of the welcome back function.
- **Send Object Trigger** [Press Button / Detect Presence]: sets whether the welcome back object is sending after a touch in the screen or when the proximity sensor detects presence.
- **Additional Condition** [No Additional Condition / Do Not Send Unless All Additional Conditions are 0 / Do Not Send Unless All Additional Conditions are 1 / Do Not Send at Less One of the Additional Conditions is 0 / Do Not Send at Less One of the Additional Conditions is 1]: condition that must be fulfilled for sending the welcome object. When selecting any condition, the following parameter appears:
 - **Number of Condition Objects** [1...5]: up to 5 objects can be enabled for the additional condition.

- **Welcome Back Object (1-Bit)** [[disabled](#) / [enabled](#)]: checkbox to enable the sending of a 1-bit value (through “[**General**] **Welcome back**”) when the welcome back function is triggered and the condition (if any) evaluates to true. The desired value should to be set in **Value** [[Send 0](#) / [Send 1](#)].
- **Welcome Back Object (Scene)** [[disabled](#) / [enabled](#)]: checkbox to enable the sending of a scene run request (through “[**General**] **Scene: send**”) when the welcome back function is triggered and the condition (if any) evaluates to true. The desired value should to be set in **Scene Number** [[1...64](#)].

2.2 DISPLAY

2.2.1 PAGES

The user interface is organised into **pages** (up to twelve different pages, in addition to the 'Configuration Page'), each of which can be accessed from the Menu page, which (unless the contrary has been parameterised) is automatically shown after the start-up.

The twelve pages are **general purpose**, at the entire disposal of the integrator, who may include up to twelve controls with different functionalities per page. The remaining **Configuration** page is specific purpose, as it is provided for user customisation of the device.

The user interface permanently shows a top bar with the current page name, current time of day and temperature, and if desired, a button that allows the user to return to the "Home" page:



Figure 50. "Home" button

In addition, from the menu page, and provided that it has been enabled, the configuration page can be accessed via a button located in the navigation bar will be possible.



Figure 51. Configuration button

ETS PARAMETERISATION

Figure 52. General pages configuration

The parameters available are:

- **Number of Pages** [[1...12](#)]: number of general purpose pages that will be activated on the device. For each page a dedicated ETS tab will be shown for configuration.
- **Default Page** [[Menu](#)]: dropdown list that sets the page that will behave as the default page. This page will be the one shown after the inactivity time elapsed.
- **Menu Page** [[disabled](#) / [enabled](#)]: enables or disables a page with direct access to available general-purpose pages.
- **Home Button in the Navigation Bar** [[disabled](#) / [enabled](#)]: if enabled, the following parameter will be displayed:
 - **Page Linked to the Home Button** [[Menu](#)]: select the page to which the device will navigate when the “Home” button is pressed.
- **Configuration Page** [[disabled](#) / [enabled](#)]: if enabled, direct access to the configuration page from the menu page will be allowed.
- **Pages Distribution** [[Empty](#) / [1 Page](#) / ... / [12 Page](#)]: set which page, from a list of 12, will be placed in each of the twelve possible boxes on the screen.

2.2.1.1 MENU

The user interface may have up to twelve pages of general purpose, each of which can host up to twelve different controls or indicators.



Figure 53. Menu Page

ETS PARAMETERISATION

The **Menu** tab allows defining generic options regarding the enabled control pages, which can be accessed from this screen.

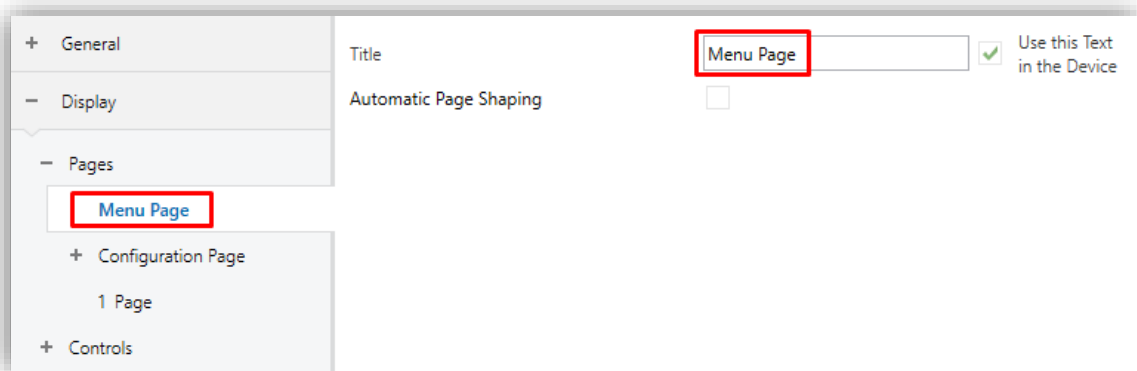

Figure 54. Menu

The parameters available are:

- **Title:** text field that identifies the menu pages. In addition, this field allows changing the name of the tab in ETS left menu, as shown in the Figure 54.
- **Use this Text in the Device** [*disabled / enabled*]: enables the text to be used as the page title in the device.

- **Automatic Page Shaping** [*disabled / enabled*]: enables choosing whether the pages in Menu should be automatically distributed depending on the number of pages configured, or be displayed as a static 3x4 grid.

2.2.1.2 CONFIGURATION PAGE

The Configuration page lets the user to know or adjust certain technical values about the device, as well as customise the visual and audio adjustments of the user interface:

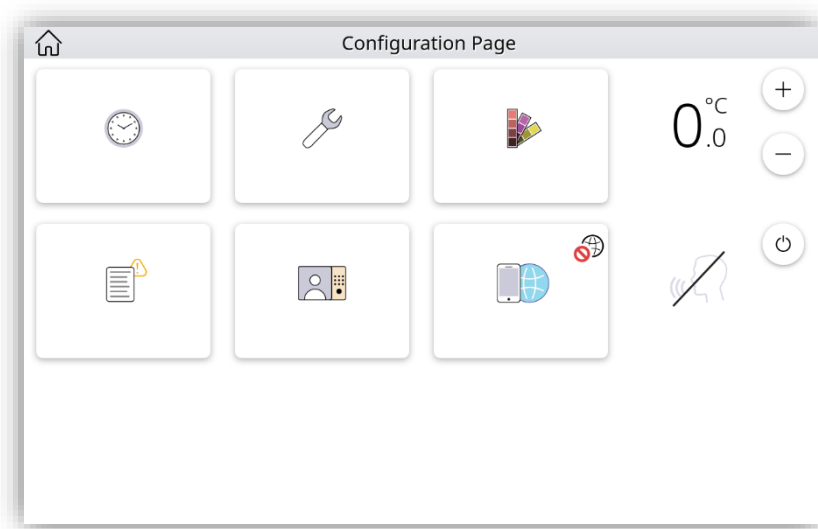

Figure 55. Configuration Page

ETS PARAMETERISATION

After enabling the **Configuration Page** from “Pages” screen (see section 2.2.1), a new tab will be incorporated into the tree on the left.

The screenshot displays the configuration interface for a Zennio device. On the left, a sidebar menu is visible with categories: General, Display, Pages, and Controls. Under 'Pages', 'Configuration Page' is selected and highlighted in blue. The main area shows the configuration for this page, including fields for Title, Automatic Page Shaping, Accessible From, Protect, Time/Date, Label, Profile, Alarm Log, Device Pairing, Voice Control, and Probe Calibration. Each setting has a corresponding input field or radio button.

Setting	Value / Option
Title	[Text Field] <input checked="" type="checkbox"/> Use this Text in the Device
Automatic Page Shaping	<input checked="" type="radio"/> No <input type="radio"/> Yes
Accessible From	<input checked="" type="radio"/> Menu <input type="radio"/> Any Page
Protect	<input checked="" type="radio"/> No <input type="radio"/> Yes
Time/Date	<input checked="" type="checkbox"/>
Label	[Text Field]
Protect	<input checked="" type="radio"/> No <input type="radio"/> Yes
Object to Show/Hide Box	<input type="checkbox"/>
Device	<input checked="" type="checkbox"/>
Label	[Text Field]
Protect	<input checked="" type="radio"/> No <input type="radio"/> Yes
Object to Show/Hide Box	<input type="checkbox"/>
Profile	<input checked="" type="checkbox"/>
Label	[Text Field]
Protect	<input checked="" type="radio"/> No <input type="radio"/> Yes
Object to Show/Hide Box	<input type="checkbox"/>
Probe Calibration	<input type="checkbox"/>
<div style="border: 1px solid #ccc; padding: 5px; background-color: #f0f0f0;"> <p>i To enable this box, it must be enabled the internal probe under "General/Configuration"</p> </div>	
Alarm Log	<input type="checkbox"/>
Device Pairing	<input checked="" type="checkbox"/>
Label	[Text Field]
Protect	<input checked="" type="radio"/> No <input type="radio"/> Yes
Object to Show/Hide Box	<input type="checkbox"/>
Voice Control	<input checked="" type="checkbox"/>
Label	[Text Field]
Protect	<input checked="" type="radio"/> No <input type="radio"/> Yes
Object to Show/Hide Box	<input type="checkbox"/>

Figure 56. Configuration tab

- **Title:** text field that identifies the configuration page. In addition, this field allows changing the name of the tab in ETS left menu, as shown in the Figure 56.
- **Use this Text in the Device** [*disabled* / *enabled*]: allows the text to be used as the page title in the device.
- **Automatic Page Shaping** [*No* / *Yes*]: allows choosing whether the boxes in the Configuration Page should be automatically distributed depending on the number of boxes configured, or be displayed as a static 3x4 grid.

- **Accessible From** [[Menu](#) / [Any Page](#)]: sets whether the access button to the configuration page appears on all pages or only on the menu page.
- **Protect**: sets whether the page will be password-protected or not. Depending on the security levels configured (one or two; see section 2.1.6) this list will contain the following options:
 - **One Level**:
 - [[No](#) / [Yes](#)]: sets whether the page is password-protected at level 1 or without a password.
 - **Two Levels**:
 - [[No](#) / [Level 1](#) / [Level 2](#)]: sets the level of security to access the configuration page.
- **Time/Date** [[disabled](#) / [enabled](#)]: if enabled, the date and time of the device can be set directly from the user interface:

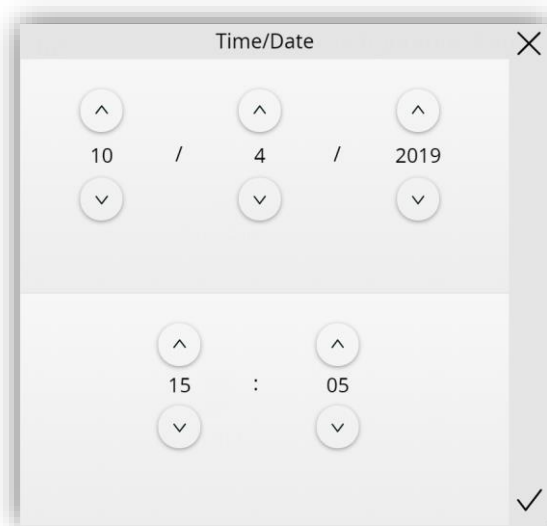

Figure 57. Time and date

- **Device** [[disabled](#) / [enabled](#)]: enables or disables the “Device” tab in the left menu. For more information, see section 2.2.1.2.1
- **Profile** [[disabled](#) / [enabled](#)]: enables or disables the “Profile” tab in the left menu. For more information, see section 2.2.1.2.2
- **Probe Calibration** [[disabled](#) / [enabled](#)]: enables or disables the box to configure the offset of the internal temperature probe.

- **Alarm Log** [[disabled](#) / [enabled](#)]: enables or disables the alarm log box that provides access to the log file where alarm events are incorporated, in reverse chronological order, with the name, time and date of every alarm event will being shown. In addition, the log will show the current status of each of them:



Alarm State	Icon
Alarm active	
Alarm finished, but not confirmed	
Alarm confirmed, but not finished	
Alarm finished and confirmed	OK

Table 4. Alarm Log Icons

This centralised file may be useful when the user needs to check the status of a set of alarm controls distributed across several pages.

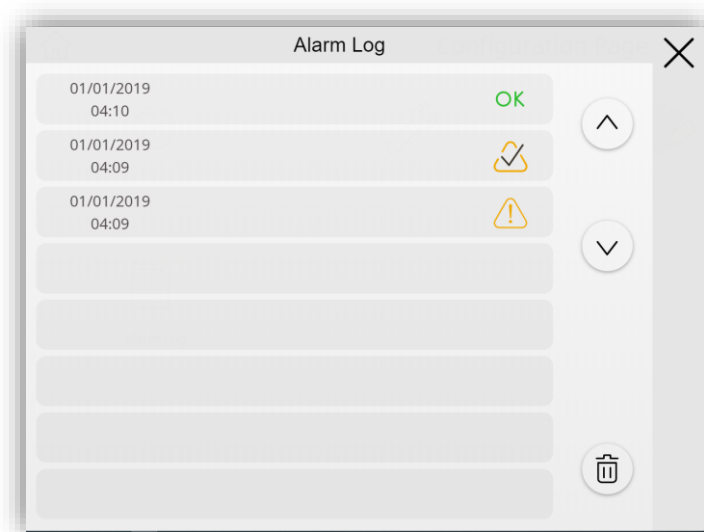



Figure 58. Alarm Log

To delete the record, press and hold the button , at the bottom right of the window for more than 3 seconds.

Note: For information on alarms, see section 2.2.2.1.5.4.

- **VoIP Calls** [[disabled](#) / [enabled](#)] (License required): enables or disables the “VoIP Calls” tab in the left menu. For more information, see section 2.2.1.2.3.
- **Device Pairing** [[enabled](#)] (License required): button to access to the pairing function, which must be executed with each device desired to control the

touchscreen remotely. For more details, please refer to [ANNEX III. Remote Control via IP](#).

- **Voice Control** [[enabled](#)] (License required): enable the box to activate or deactivate voice control function. Please refer to the user manual “**ZenVoice**” (available in the product section at the Zennio homepage, www.zennio.com) for detailed information about the functionality and the configuration.

Note: *the voice control and device pairing boxes will always be visible when the Remote Control parameter is enabled and hidden when the Remote Control parameter is disabled.*

Moreover, for all these controls, the following parameters can be configured:

- **Label:** text that will appear to identify the box.
- **Protect** [[No / Yes](#)] / [[No / Level 1 / Level 2](#)]: exactly the same as the page protection explained above, but for the boxes.
- **Object to Show/Hide Box** [[disabled / enabled](#)]: when this option is enabled, a new 1-bit object appears (“**[Config.][Bi] Show/Hide Box**”) that allows hiding / showing the box through the KNX bus.

2.2.1.2.1 Device

The configuration page, if **Device** is enabled, will display a button allowing access to several controls and indicators with device-specific information:

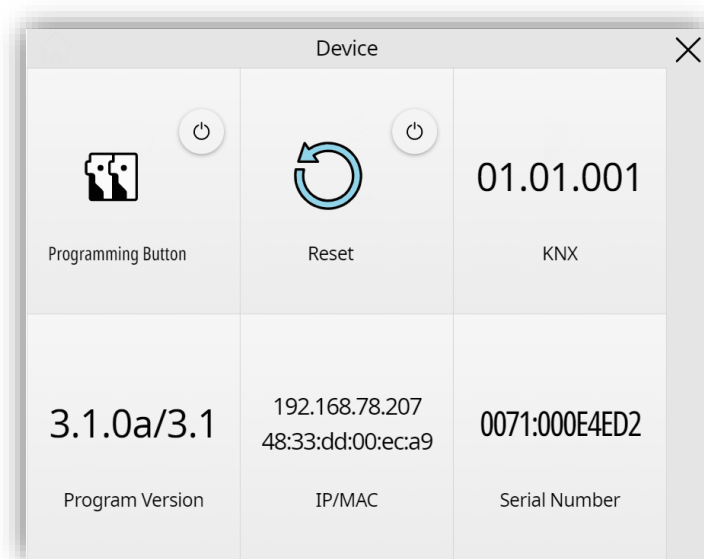

Figure 59. Device

ETS PARAMETERISATION

After enabling the **Device** from “Configuration Page” screen (see section 2.2.1.2), a new tab will be incorporated into the tree on the left.

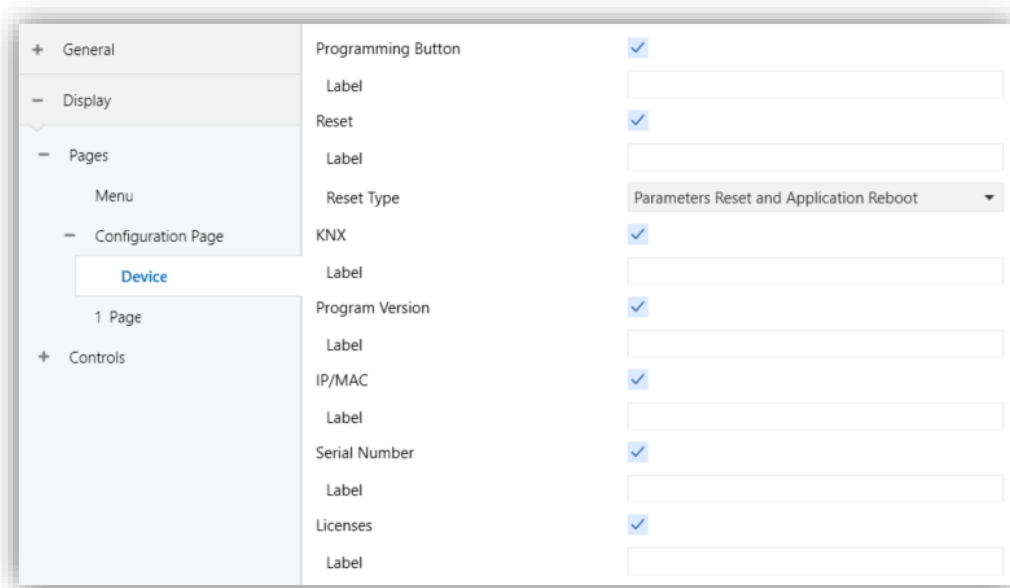

Figure 60. Configuration Page. Device

- **Programming Button** [*disabled* / *enabled*]: control/indicator that shows the status of the Prog./Test LED of the device. In particular, it permits entering/leaving the programming mode as by pressing the actual programming button of the device.
- **Reset** [*disabled* / *enabled*]: enables or disables the box to perform a reset on the device, by pressing more than 3 seconds the button:
 - **Reset Type:**
 - [*Parameters Reset*]: similar to restoring the device to the just-parameterised state.
 - [*Application Reboot*]: simple device reset, with no data loss.
 - [*Parameters Reset and Application Reboot*]: the above two, combined.
- **KNX** [*disabled* / *enabled*]: indicator that shows the individual address of the device.
- **Program Version** [*disabled* / *enabled*]: indicates the downloaded firmware and program version.
- **IP/MAC** [*disabled* / *enabled*]: indicates the IP and MAC direction.

- **Serial number** [*disabled* / *enabled*]: indicates the device serial number.
- **Licenses** [*disabled* / *enabled*]: indicates the licences that are installed on the device. Uninstalled licences will be displayed in light grey.

Moreover, for all these controls, the following parameter can be configured:

- **Label:** text that will appear to identify the box.

2.2.1.2.2 Profile

The configuration page, if **Device** is enabled, will display a button to access the visual and sound settings of the device:

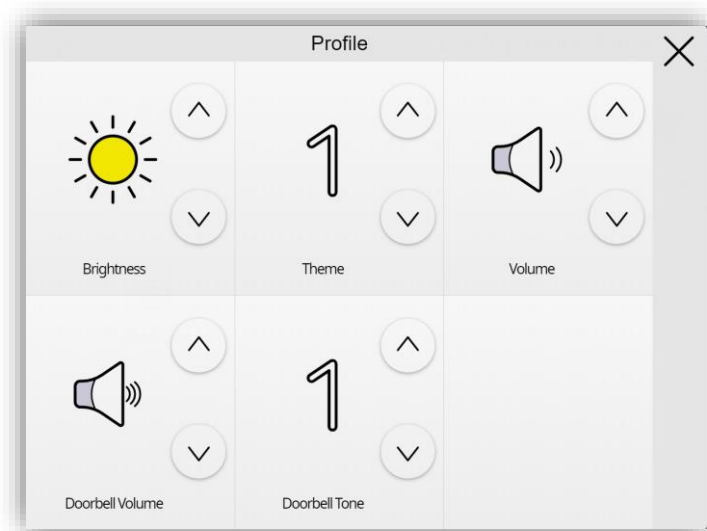

Figure 61. Profile

ETS PARAMETERISATION

After enabling the **Profile** from “Configuration Page” screen (see section 2.2.1.2), a new tab will be incorporated into the tree on the left.

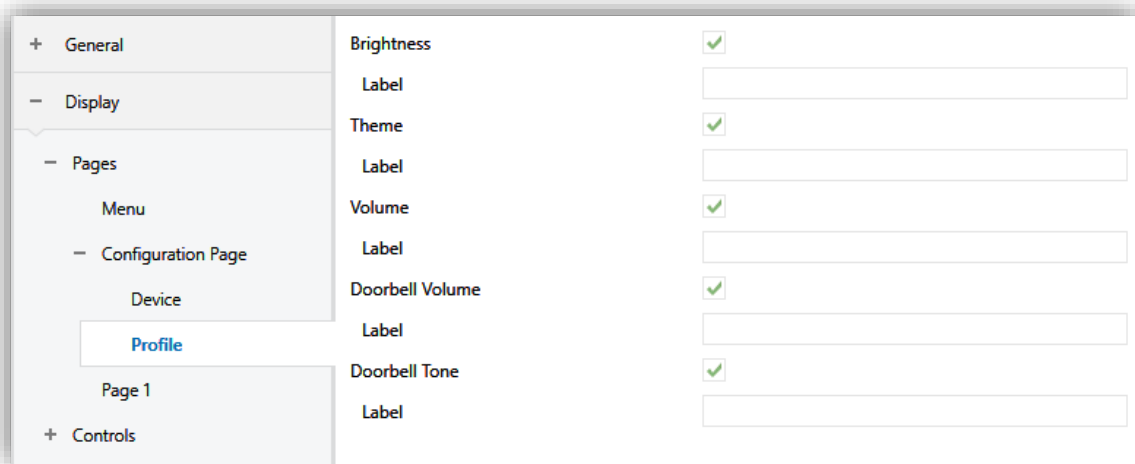

Figure 62. Configuration Page. Profile

- **Brightness** [*disabled* / *enabled*]: enables or disables the box to adjust the brightness of the display.
- **Theme** [*disabled* / *enabled*]: enables or disables the box for the selection of the theme.
- **Volume** [*disabled* / *enabled*]: box to control the volume of pulsation and sending sound. There are three volume levels in addition to the mute option.
- **Doorbell Volume** [*disabled* / *enabled*]: box to control the volume of doorbell. There are five volume levels in addition to the mute option.
- **Doorbell Tone** [*disabled* / *enabled*]: desired tone (among seven different options) for the acoustic signals emitted on doorbell.

Note: Doorbell boxes will be only available if the “**Object for Doorbell**” parameter is enabled in the custom sounds tab (see section 2.1.13).

2.2.1.2.3 VoIP Calls (License Required)

The configuration page, if **VoIP Calls** is enabled, will display a button to access the video intercom and internal call settings of the device:

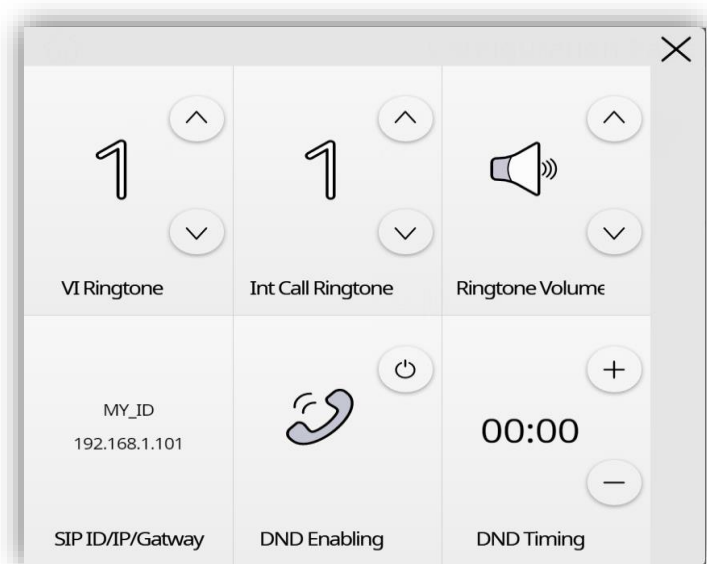

Figure 63. VoIP Calls

ETS PARAMETERISATION

After enabling the **VoIP Calls** from “Configuration Page” screen (see section 2.2.1.2), a new tab will be incorporated into the tree on the left.

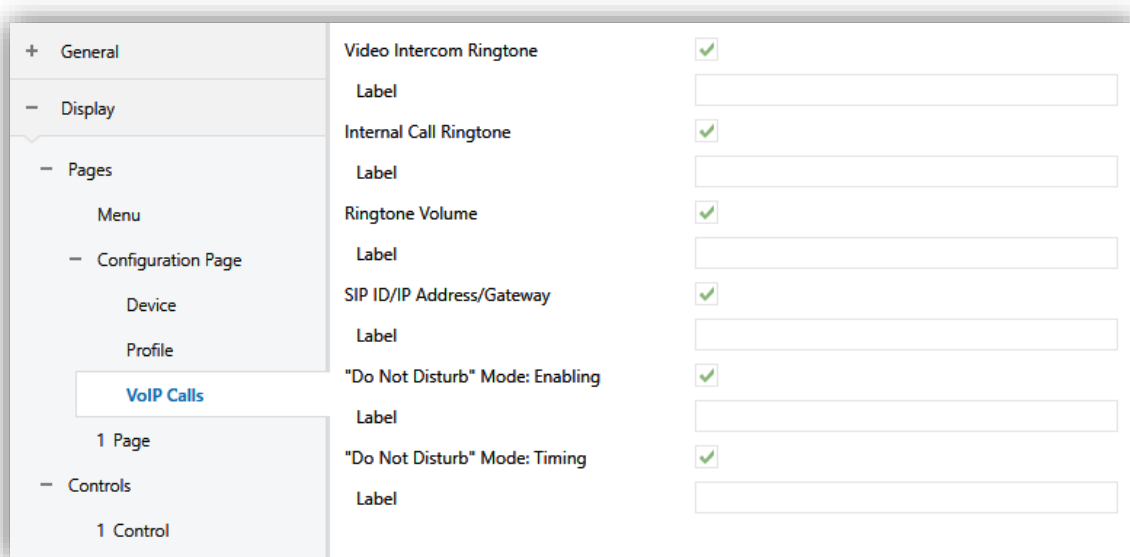

Figure 64. Configuration page - VoIP calls

- **Video Intercom Ringtone** [*disabled* / *enabled*]: box to change the melody to be played when receiving a call from an external unit.
- **Internal Call Ringtone** [*disabled* / *enabled*]: box to change the melody to be played when receiving a call for an internal unit.

- **Ringtone Volume** [*disabled / enabled*]: enables the box to modify the calls tone volume.
- **SIP ID/IP Address/Gateway** [*disabled / enabled*]: information box showing the ID, IP address and gateway, as configured in “IP Configuration” tab (see section 2.1.15)
- **“Do Not Disturb” Mode: Enabling** [*disabled / enabled*]: checkbox to enable or disable the do not disturb mode. When enabled, incoming calls will not be received. However, in case of Video Intercom functionality, they will be registered in the call log.

When enabling the mode, the value ‘1’ is sent through the object “[VoIP] “Do Not Disturb” Mode” and when disabling it is sent the value ‘0’.

Note: *if do not disturb mode is enabled during a call, the call will go through normally and the mode will be activated when the call finishes.*

- **“Do Not Disturb” Mode: Timing** [*disabled / enabled*]: this box set the time that the do not disturb mode will be active. A time 0 will activate this mode indefinitely.

When enabling the mode, the value ‘1’ is sent through the object “[VoIP] “Do Not Disturb” Mode” and when the timing expires it is sent the value ‘0’. It is also possible to stop the countdown disabling the mode (by manually or through the communication object).

2.2.1.3 PAGE N

Z50 / Z70 v2 / Z100 has up to twelve general purpose pages that can be enabled from the "Pages" tab. Thus, a new tab called **Page n** will be displayed for each of the *n* enabled pages.

Inside each page, the desired controls can be placed as boxes arranged in order, according to the parameters for each page. In addition, larger boxes can be created by grouping 4 boxes, with a format of 2x2. To make this type of grouping it is necessary to configure the page as shown in Figure 65.

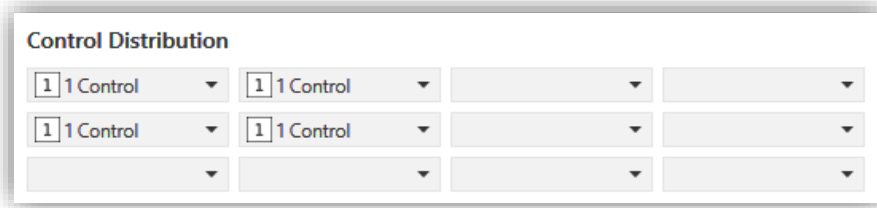

Figure 65. 2x2 Boxes Configuration

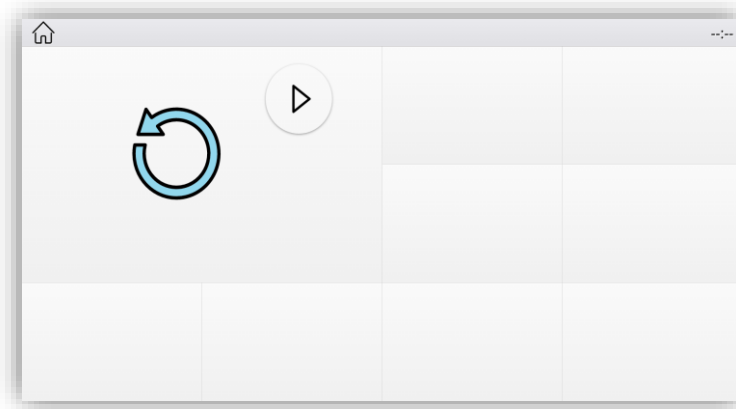

Figure 66. 2x2 Box Visualization

ETS PARAMETERISATION

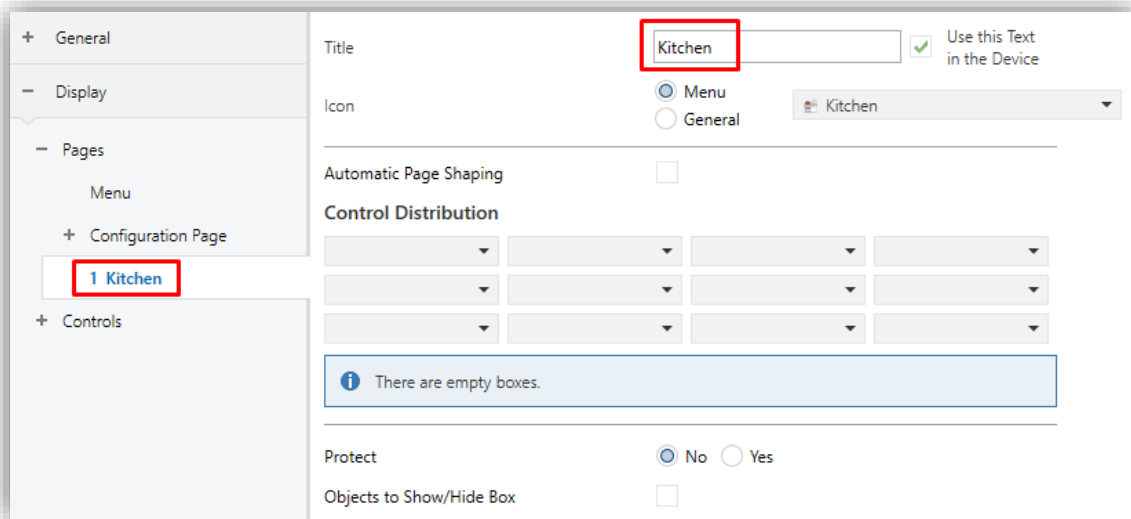

Figure 67. Configuration Page n

This screen contains the following parameters:

- **Title:** text field that identifies each of the enabled pages. In addition, this field allows changing the name of the tab in ETS left menu, as shown in the Figure 67.
- **Use this Text in the Device** [*disabled* / *enabled*]: allows the text to be used as the page title in the device.

- **Icon** [[Kitchen](#)]: sets the icon that will represent the page in the Menu page. It could be selected from two available lists [[Menu / General](#)].
 - “[Menu](#)” is a list of the most common icons that are configured in the main menu.
 - “[General](#)” is a list of all available icons. At the end of the list, customised icons, that must have been previously imported, can be selected (see section 2.1.14.4).

Note: a list with all icons available can be found in document “Icon list”, available at www.zennio.com.

- **Automatic Page Shaping** [[disabled](#) / [enabled](#)]: enables to choose whether the controls should be automatically or be displayed as a static grid.

Note: if automatic page shaping is enabled, grouping of 2x2 cells is not possible.

- **Control Distribution** [[Nothing](#) / [Control 1...Control 180](#)]: enables selecting which control, from a list of 180 controls, will be placed in each of the twelve possible boxes on the screen.
- **Protect:** sets whether the page will be password-protected or not. Depending on the security levels configured (one or two; see section 2.1.6) this list will contain the following options:
 - **One Level:**
 - [[No](#) / [Yes](#)]: sets whether the page is password-protected at level 1 or without a password.
 - **Two Levels:**
 - [[No](#) / [Level 1](#) / [Level 2](#)]: sets the level of security to access the page.
- **Objects to Show/Hide Box** [[disabled](#) / [enabled](#)]: enables or disables a 1-bit object for each enabled box in which a control has been configured (“**[Pn][Bi] Show/Hide Box**”) to show or hide the corresponding box.

2.2.2 CONTROLS

User interface can have up to 180 different controls placed on 12 pages. Each of this controls will be configurated independently and placed in the desire box of the page (see section 2.2.1.3).

Within the controls tab, sub-tabs with groupings of up to 15 controls each are displayed to do parameterization easier.

ETS PARAMETERISATION

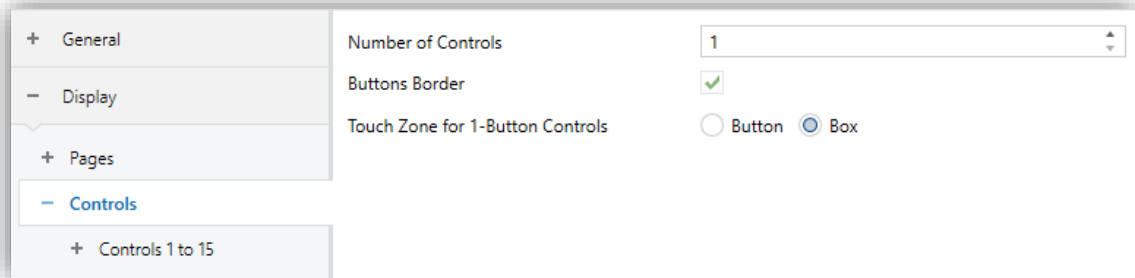

Figure 68. Controls configuration

- **Number of Controls** [[1...180](#)]: selects the number of controls that will become available. For each of them a new ETS tab will be shown.
- **Buttons Border** [[disabled](#) / [enabled](#)]: sets whether the buttons will have an outline or if only the button icon is displayed.
- **Touch Zone for 1-Button Controls**: this parameter defines whether the touch zone for 1-button controls is the entire box or a separated button. The behavior in each case is:
 - [[Box](#)]: actions will take place by clicking anywhere in the box.
 - [[Button](#)]: a separate button will be displayed in the upper right of the box. The control will be only executed when the button area is clicked.

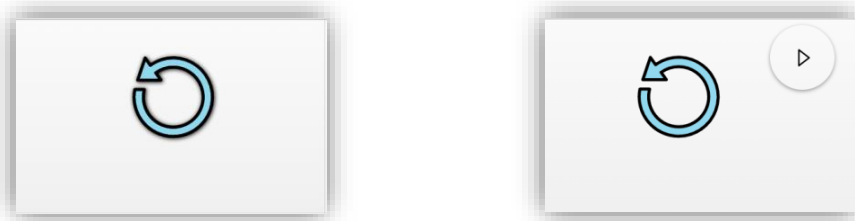
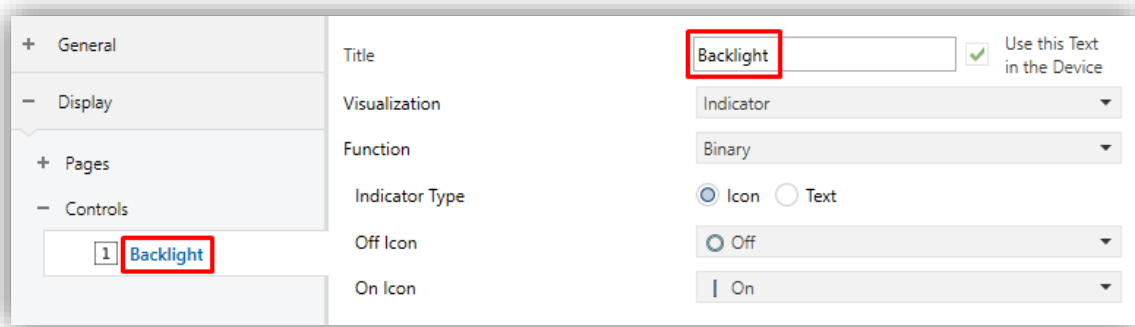

Figure 69. Touch zone in box vs in button

2.2.2.1 CONTROL *i*

This screen contains the following parameters common to all type of boxes:

Figure 70. Control *i*

- **Title:** text field that identifies each of the enabled controls and their communication objects, which are designated with the prefix “[Cx][Title]”.

In addition, this field allows changing the name of the tab in ETS left menu, as shown in the Figure 70.

- **Use this Text in the Device** [*disabled* / *enabled*]: allows the text to be used as the box label where this control is placed in the device.
- **Visualization:** box format. The available box formats are:
 - [*Indicator*]: the box will work as a status indicator.
 - [*1-Button Control*]: the box will work as a one-button control.
 - [*2-Button Control*]: the box will work not only as a status indicator, but also as a two-button control.
 - [*Climate Control*]: the box will act as a climate indicator and a climate control.
 - [*Other*]: the box will implement some other special functionality.
- **Function:** depending on the “Visualization” type selected, the parameters below will change. The following sections explain the available parameters depending on the visualization type selected.
- **Slider** [*disabled* / *enabled*]: sets whether control is via buttons or via a slider. The following is a list of 2-button controls where this option exists:
 - Percentage
 - Dimmer
 - Shutter
 - Temperature Setpoint control

- **Minimum Increment:** step value that the slider will have.

Note: in some cases, like shutters or lighting, the control objects may vary, having precise control objects when the control has been configured as a slider.

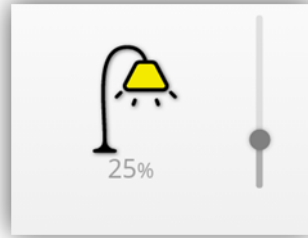

Figure 71. Slider Control

- **Icon and/or Button:** drop-down list with the available icons to show in the indicator(s) and/or button(s) of the box. At the end of the list, the custom icons (“Cx”) that must have been previously imported, can be selected (see section 2.1.14.4).

Note: a list with all icons available can be found in document “Icon list”, available at www.zennio.com.

- **Log & Graph** [[Disable](#) / [Record Log](#) / [Record Log and Show Graph](#)]: sets if received data through the indicator object will be recorded and if the graph will be displayed. See ANNEX IV. Graphs for more information.

If [Record Log and Show Graph](#) is enabled, the following parameters will be displayed:

- **Show Hour Zoom** [[disabled](#) / [enabled](#)]: sets whether the hour zoom is enabled on the control graph.
- **Graph Type** [[Curve](#) / [Straight](#) / [Step](#)]: graph types available for the control. The options for this parameter will depend on the type of control chosen and will only be displayed for non-binary types.
- **Polarity** [[0 = Low Level; 1 = High Level](#) / [0 = High Level; 1 = Low Level](#)]: sets which is the high level and which is the low level depending on the value received. This parameter will only be displayed on binary type controls.
- **Protect:** sets whether the box will be password-protected or not. Depending on the security levels configured (one or two; see section 2.1.6) this list will contain the following options:
 - **One Level:**

- [\[No / Yes\]](#): sets whether the control is password-protected at level 1 or without a password.

➤ **Two Levels:**

- [\[No / Level 1 / Level 2\]](#): sets the level of security to operate on the control.

Note: *neither indicators nor change-scale buttons can be protected.*

2.2.2.1.1 INDICATORS

Controls designed for displaying statuses, showing a numeric or text value, or displaying an icon that represents the current value of a communication object.

2.2.2.1.1.1 Binary

When this function is assigned to a control, the “[Ci] Binary Indicator” communication object become available, as well as following parameters:

Visualization	Indicator
Function	Binary
Indicator Type	<input checked="" type="radio"/> Icon <input type="radio"/> Text
Off Icon	Off
On Icon	On

Figure 72. Indicator - Binary

- **Indicator Type** [\[Icon / Text\]](#): allows selecting whether the status represented by each indicator value will be text type or icon type.

2.2.2.1.1.2 Enumeration

The box will behave analogously to the case of the **Binary Indicator** however, it will be possible to distinguish up to 6 states.

When this function is assigned to a control, a 1-byte communication object, “[Ci] Enumeration Indicator”, will become available as well as a series of parameters:

Figure 73. Indicator - Enumeration

- **Number of Value** [1...2...6]: sets the number of states in the enumerated list. For every distinguished state, the parameter **Value** [0...255] will become available together with the corresponding indicator.
- **Indicator Type** [*Icon* / *Text*]: enables to select whether the status indicator which each value is represented will be text type or icon type. As many drop-down lists of icons or text boxes will be displayed as states have been enabled in the previous parameter.

2.2.2.1.1.3 Numerical Indicators

Indicators configured as “Integer”, “Percentage”, “Float”, “Temperature” and “Cost” are numerical type indicators that show the value of the corresponding communication object, enabled when that control is assigned to a box.

Figure 74. Indicator - Numerical

The range of values allowed for each type and the name of the corresponding object are included in the following table.

Function	Size	Sign	Range	Related Object
<i>Integer</i>	<i>1 Byte</i>	<i>Unsigned</i>	0 – 255	[Ci] 1-Byte Unsigned Int Indicator

		<u>Signed</u>	-128 – 127	[Ci] 1-Byte Signed Int Indicator
	<u>2 Bytes</u>	<u>Unsigned</u>	0 – 65535	[Ci] 2-Byte Unsigned Int Indicator
		<u>Signed</u>	-32768 – 32767	[Ci] 2-Byte Signed Int Indicator
	<u>4 Bytes</u>	<u>Unsigned</u>	0 – 4294967295	[Ci] 4-Byte Unsigned Int Indicator
<u>Signed</u>		-2147483648 – 2147483647	[Ci] 4-Byte Signed Int Indicator	
<u>Percentage</u>	<u>1 Byte</u>		0 – 100	[Ci] Percentage Indicator
<u>Float</u>	<u>2 Bytes</u>		-671088.64 – 670433.28	[Ci] 2-Byte Float Indicator
	<u>4 Bytes</u>		-3,403x10 ³⁸ – 3,403x10 ³⁸	[Ci] 4-Byte Float Indicator
<u>Temperature</u>	<u>2 Bytes</u>	<u>Float</u>	-99 – 199	[Ci] Temperature Indicator
<u>Cost</u>	<u>1 Byte</u>	<u>Unsigned</u>	0 – 255	[Ci] Cost Indicator: 1-Byte Unsigned Int
		<u>Signed</u>	-128 – 127	[Ci] Cost Indicator: 1-Byte Signed Int
	<u>2 Bytes</u>	<u>Unsigned</u>	0 – 65535	[Ci] Cost Indicator: 2-Byte Unsigned Int
		<u>Signed</u>	-32768 – 32767	[Ci] Cost Indicator: 2-Byte Signed Int
	<u>2 Bytes</u>	<u>Float</u>	-671088.64 – 670433.28	[Ci] Cost Indicator: 2-Byte Float

Table 5. Numerical indicators

- **Decimal Places** [0 / 1 / 2]: if the control is set as float, this parameter define the number of decimal displayed in the box.
- **Units**: permits specifying the measuring units of the displayed value.

Note:

- For percentage indicator, the symbol % always will be displayed as unit.
- The temperature indicator will be shown in °C or °F depending on the active locale (see section 2.1.3). In addition, the following parameters will be available for this control type:
 - **Button to Change between °C and °F** [disabled/enabled]: enables a control that allows the temperature scale to be changed from the box itself:



Figure 75. Indicator - Temperature (box)

- **Include Plus Sign before Positive Numbers** [disabled/enabled]: shows the '+' sign before positive temperature values.

- For cost indicator, choosing as a unit the currency associated with it, from a list of available ones, will be mandatory. This will be placed before or after the indicator, according to the active locale (see section 2.1.3).

2.2.2.1.1.4 Text

The box will show the text received through the communication object “[Ci] Text Indicator”.

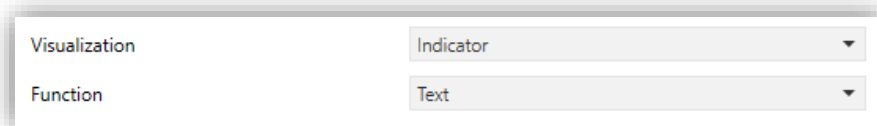

Figure 76. Indicator - Text

2.2.2.1.2 1-BUTTON CONTROL

The box configured with this control type will have a button (at the top right or throughout the box, see section 2.2.2) and a state indicator. In addition, through **Function** parameter, it will be possible to select the specific function that the control will perform.

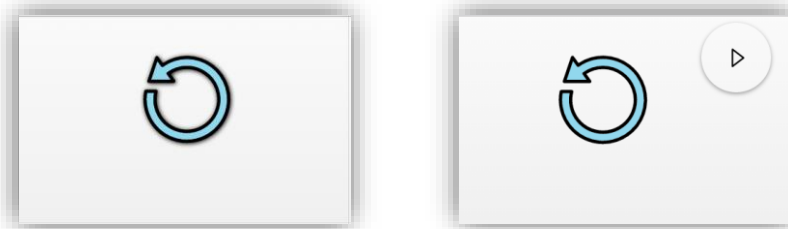

Figure 77. 1-Button Control (Box)

2.2.2.1.2.1 Switch

The button of the box will react to user presses by sending a binary value to the bus through the “[Ci] Switch” object. In addition, this control will have associated a dedicated object for the box indicator (“[Ci] Binary Indicator”), which is automatically updated after the control order is sent and can also receive values from the bus.

Visualization	1-Button Control
Function	Switch
Action	Send 0
Indicator Type	<input checked="" type="radio"/> Icon <input type="radio"/> Text
Off Icon	<input checked="" type="radio"/> Off
On Icon	On
Button	<input type="radio"/> On/Off

Figure 78. 1-Button Control - Switch

- **Action** [[Send 0](#) / [Send 1](#) / [Toggle 0/1](#)]: specifies what value will be sent to the bus after pressing the control button.
- **Indicator Type** [[Icon](#) / [Text](#)]: allows selecting whether the status represented by each indicator value will be text type or icon type.

2.2.2.1.2.2 Two Objects (Short Press/Long Press)

The button in the box will react differently to a short press and to a long press, setting a time threshold to distinguish both types of press by parameter.

Visualization	1-Button Control
Function	Two Objects (Short Press/Long Press)
Action on Short Press	Send 0
Action on Long Press	Send 1
Long Press Threshold Time	6 x 1 ds
Off Icon	<input checked="" type="radio"/> Off
On Icon	On
Button	<input type="radio"/> Point

Figure 79. 1-Button Control - Two Objects

- **Action on Short / Long Press** [[Send 0](#) / [Send 1](#) / [Toggle 0/1](#) / [Send 1-Byte Unsigned Integer Value](#)]: sets what value will be sent to the bus before which events.

When the option “[Send 1-Byte Unsigned Integer Value](#)” is selected, the value indicated in **Value** [[0...255](#)] parameter will be sent.

Different objects are used to send values for short and long pulsations: "[Ci] Two objects - Short Press" and "[Ci] Two objects - Long Press", respectively.

If the option chosen is "Send 0" or "Send 1", the object "[Ci] Two objects - Indicator" will appear for the box indicator, which is automatically updated after the control order is sent and when values are received from the bus.

- **Long Press Threshold Time** [4...6...50] [ds]: sets the minimum time the user should hold the button in order to consider it a long press.

2.2.2.1.2.3 Hold & Release

This control function allows the user to configure sending a binary value on pressing and a different binary value on releasing the button. In addition, this control will have associated a dedicated object for the indicator ("[Ci] Binary Indicator"), which is automatically updated after the control order is sent and when values are received from the bus.

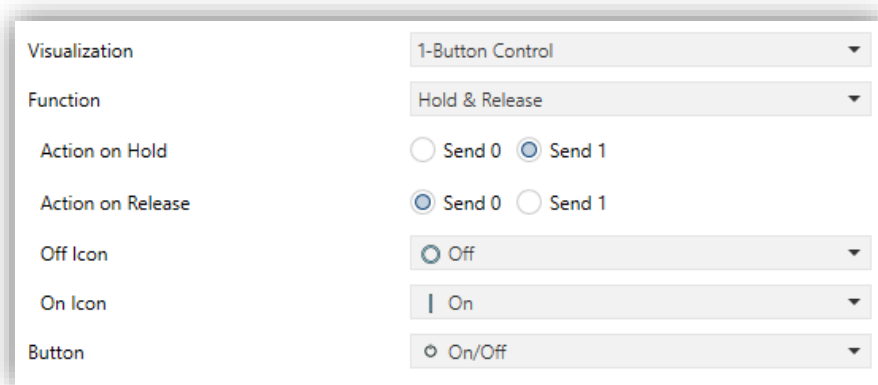

Figure 80. 1-Button Control - Hold & Release

- **Action on Hold / Release** [Send 0 / Send 1]: permits setting what value will be sent to the bus through the objects "[Ci] Hold & Release", and before which events.

2.2.2.1.2.4 Scene

When this function is assigned to a control, the box button will react to the different pulses by sending a certain scene value.

The screenshot shows a configuration window for a 1-Button Control. The settings are as follows:

- Visualization: 1-Button Control
- Function: Scene
- Action: Run Run and Save
- Scene Number: 1
- Object to Use: General Scene Object Individual Box Scene Object
- Icon: Star
- Button: Play

Figure 81. 1-Button Control - Scene

- **Action** [[Run](#) / [Run and Save](#)]: sets whether the device will only send scene execution orders (after a short press) or if it will be possible, to send scene save orders (after a long press).
- **Scene Number** [[1...64](#)]: scene value to be sent.
- **Object to Use** [[General Scene Object](#) / [Individual Box Scene Object](#)]: specifies whether the scene value will be sent through the object "[General] Scenes: Send" or through the individual object "[Ci] Scene: Send".

2.2.2.1.2.5 Constant Numerical Controls

When the functions "[Counter Constant](#)", "[Scaling Constant](#)" or "[Float Constant](#)" is assigned to a control, the button in the box will react to user presses by sending a certain numerical value. This numerical value will depend on the constant control type selected to the box.

The screenshot shows a configuration window for a 1-Button Control. The settings are as follows:

- Visualization: 1-Button Control
- Function: Counter Constant
- Size: 1 Byte 2 Bytes
- Sign: Signed Unsigned
- Object Value: 0
- Icon: No Icon
- If "No Icon" is selected the box will show the object value.
- Units: (empty field)
- Button: Play

Figure 82. 1-Button Control – Constant Numerical

Table 6 shows the permitted value range and the name of the object through which the values are sent to the bus.

Function	Size	Sign	Range	Related Object
<i>Integer</i>	<i>1 Byte</i>	<i>Unsigned</i>	[0...255]	[Ci] 1-Byte Unsigned Int Control
		<i>Signed</i>	[-128...0...127]	[Ci] 1-Byte Signed Int Control
	<i>2 Bytes</i>	<i>Unsigned</i>	[0...65535]	[Ci] 2-Byte Unsigned Int Control
		<i>Signed</i>	[-32768...32767]	[Ci] 2-Byte Signed Int Control
Scaling	1 Byte		[0...100]	[Ci] Percentage Control
Float	2 Bytes		[-671088.64...0...670433.28]	[Ci] 2-Byte Float Indicator

Table 6. Numerical constant controls

- **Decimal Places** [0 / 1 / 2]: if the control is set as float, this parameter define the number of decimal places displayed in the box.
- **Units**: permits specifying the measuring units of the displayed value. For percentage indicators, the symbol % always will be displayed as unit.

2.2.2.1.2.6 Room State

Configuring with this function the box, controlling the states of the room will be possible, as well as show the associated pop-up. Thus, pressing the button in the box will cause the room status to switch between *normal* and *Do Not Disturb* or *Make Up Room*.

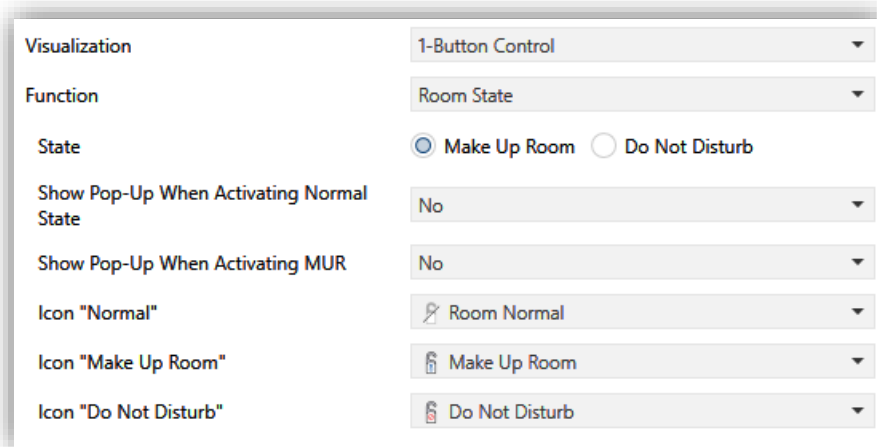

Figure 83. 1-Button Control - Room State.

- **State** [*Make Up Room* / *Do Not Disturb*]: sets the status to be switched together with Normal. The switched values are sent to the bus via the 1-byte object "[Ci] Room State".

- **Show Pop-Up When Activating Normal State** [[No](#) / [Pop-Up 1](#) / ... / [Pop-Up 6](#)]: allows to select the pop-up to be displayed when the normal mode is activated.
- **Show Pop-Up When Activating MUR** [[No](#) / [Pop-Up 1](#) / ... / [Pop-Up 6](#)]: allows to select the pop-up to be displayed when the MUR mode is activated.

Note: *the pop-ups selected must be activated (see section 2.1.18.2).*

This control will have associated a dedicated object for the indicator (“**[Ci] Room State Indicator**”), which is automatically updated after the control order is sent and when values are received from the bus.

2.2.2.1.2.7 Enumeration

The box will behave analogously to the case of the switch, however the communication objects (control object “**[Ci] Enumeration Control**” and the status “**[Ci] Enumeration Indicator**”) will be 1-byte. Up to six discrete states can be distinguished depending on the value that the status object acquires from the control or receives from the bus.

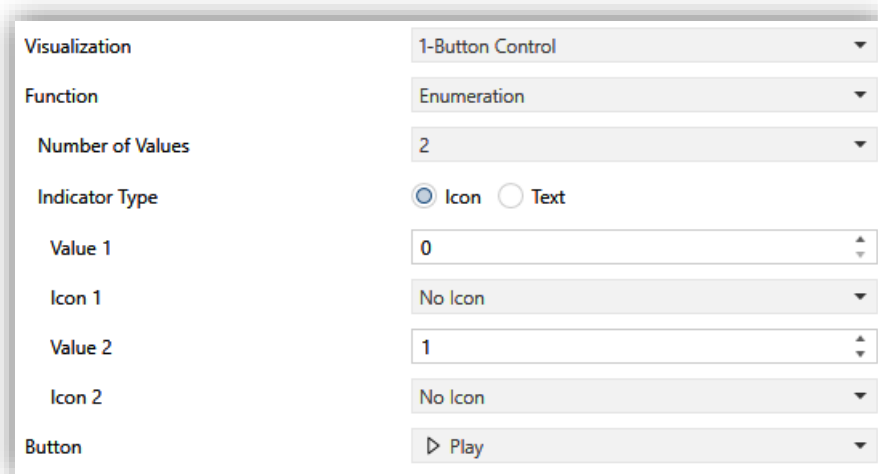

Visualization	1-Button Control
Function	Enumeration
Number of Values	2
Indicator Type	<input checked="" type="radio"/> Icon <input type="radio"/> Text
Value 1	0
Icon 1	No Icon
Value 2	1
Icon 2	No Icon
Button	▶ Play

Figure 84. 1-Button Control – Enumeration.

The available parameters are:

- **Number of Values** [[1](#)...[2](#)...[6](#)]: number of states that will be distinguished. For every distinguished state, the parameter **Value** [[0](#)...[255](#)] will become available together with the corresponding indicator.
- **Indicator Type** [[Icon](#) / [Text](#)]: allows selecting whether the status indicator which each value is represented will be text type or icon type. As many drop-down lists of icons or text boxes will be displayed as states have been enabled in the previous parameter.

2.2.2.1.3 2-BUTTON CONTROL

The box configured with this control type will have a button at the right and a state indicator. In addition, through **Function** parameter, it will be possible to select the specific function that the control will perform.



Figure 85. 2-Button Control (Box)

2.2.2.1.3.1 Switch

When the user touches the buttons in the box, a binary value will be sent through the “[Ci] Switch” object, while the status object “[Ci] Binary Indicator” will determine the icon or text shown in the box. The indicator will be updated automatically after each control order, and will also be able to receive values from the bus.

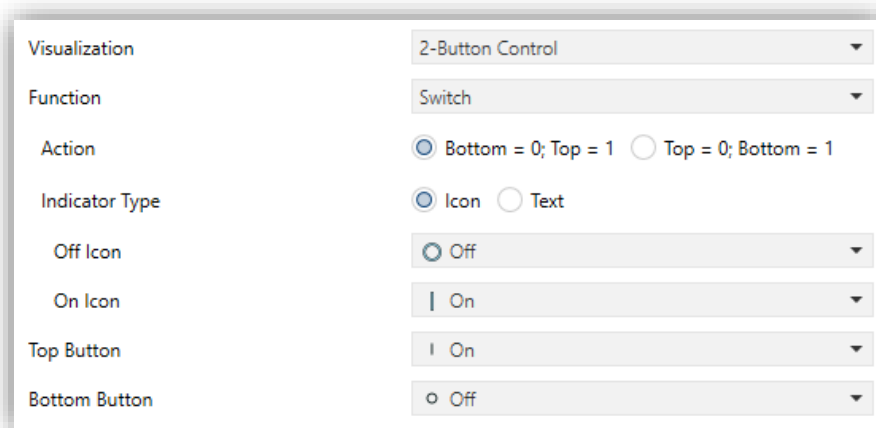

Figure 86. 2-Buttons Control - Switch

- **Action** [*Bottom = 0; Top = 1 / Top = 0; Bottom = 1*]: sets the value to be sent when pressing each of the two buttons.
- **Indicator Type** [*Icon / Text*]: allows selecting whether the status represented by each indicator value will be text type or icon type.

2.2.2.1.3.2 Switch + Indicator

In the same way the previous control, when pressing in any of the controls configured as switch, the touchscreen will send the parameterised binary value to the bus through the

object "[Ci] Switch". However, the indicator is independent and will only be updated according to the value received by the dedicated object.

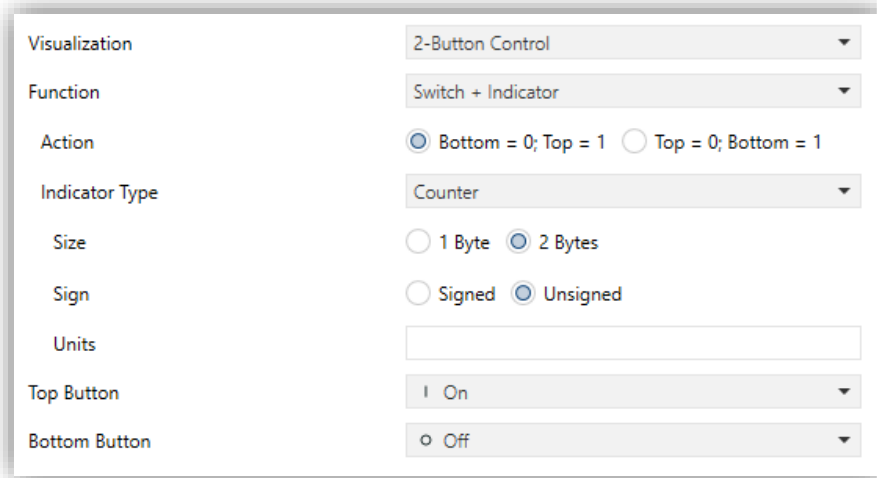

Figure 87. 2-Buttons Control - Switch + Indicator

- **Action** [[Bottom = 0; Top = 1](#) / [Top = 0; Bottom = 1](#)]: sets the value to be sent when pressing each of the two buttons.
- **Indicator Type** [[Counter](#) / [Scaling](#) / [Float](#) / [Temperature](#)]: sets the indicator type. According to the selected indicator the objects. The range of values allowed in each case and the name of the corresponding object are listed in the table.

Function	Size	Sign	Range	Related Object
Counter	1 Byte	<i>Unsigned</i>	0 – 255	[Ci] 1-Byte Unsigned Int Indicator
		<i>Signed</i>	-128 – 127	[Ci] 1-Byte Signed Int Indicator
	2 Bytes	<i>Unsigned</i>	0 – 65535	[Ci] 2-Byte Unsigned Int Indicator
		<i>Signed</i>	-32768 – 32767	[Ci] 2-Byte Signed Int Indicator
Scaling	1 Byte		0 – 100	[Ci] Percentage Indicator
Float	2 Bytes		-671088.64 – 670433.28	[Ci] 2-Byte Float Indicator
Temperature	1 Byte		-99 – 199	[Ci] Temperature Indicator

Table 7. Numerical indicators – Switch + Indicator

- **Decimal Places** [[0](#) / [1](#) / [2](#)]: if the control is set as float, this parameter define the number of decimal places displayed in the box.
- **Units**: permits specifying the measuring units of the displayed value.

Note:

- For percentage indicator, the symbol % always will be displayed as unit.

➤ The temperature indicator will be shown in °C or °F depending on the value of the active locale (see section 2.1.3). In addition, the following parameters will be available for this control type:

- **Button to Change between °C and °F [disabled / enabled]:** enables a control that allows the temperature scale to be changed from the box itself:

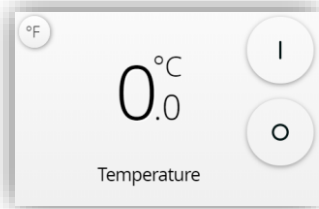

Figure 88. Temperature 2-Buttons Control (Box)

- **Include Plus Sign before Positive Numbers [disabled / enabled]:** shows the '+' sign before positive temperature values.

2.2.2.1.3.3 Two Objects (Short Press/Long Press)

Control for sending specific binary values both after a short or a long press on any of the two buttons. Two different objects are used to send values for short and long pulsations, "[Ci] Two objects - Short Press" and "[Ci] Two objects - Long Press".

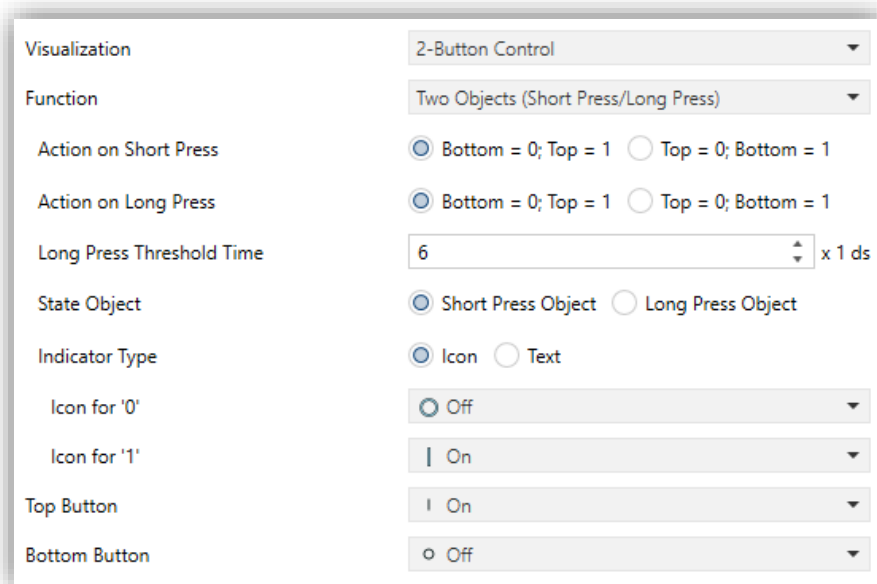

Figure 89. 2-Buttons Control - Two Objects

- **Action on Short / Long Press [Bottom = 0; Top = 1 / Top = 0; Bottom = 1]:** sets the value to be sent when short / long pressing each of the two buttons.

- **Long Press Threshold Time** [4...6...50] [ds]: sets the minimum time the user should hold the button in order to consider it a long press.
- **State Object** [[Short Press Object](#) / [Long Press Object](#)]: allows setting the control command to which the status indicator, "[Ci] Two Objects - Indicator", will obey. This object can also receive values from the bus.
- **Indicator Type** [[Icon](#) / [Text](#)]: allows selecting whether the status indicator which each value is represented will be text type or icon type.

2.2.2.1.3.4 Numerical Controls

If any of the functions “Counter”, “Scaling” or “Float” is assigned to the control, user touches over the buttons will trigger the sending of a certain numerical value to the bus. This value will be progressively increased or decreased with every touch on top button or button bottom, through the control object, while the box itself will permanently reflect the current value of the corresponding status object. This object can also receive values from the bus.

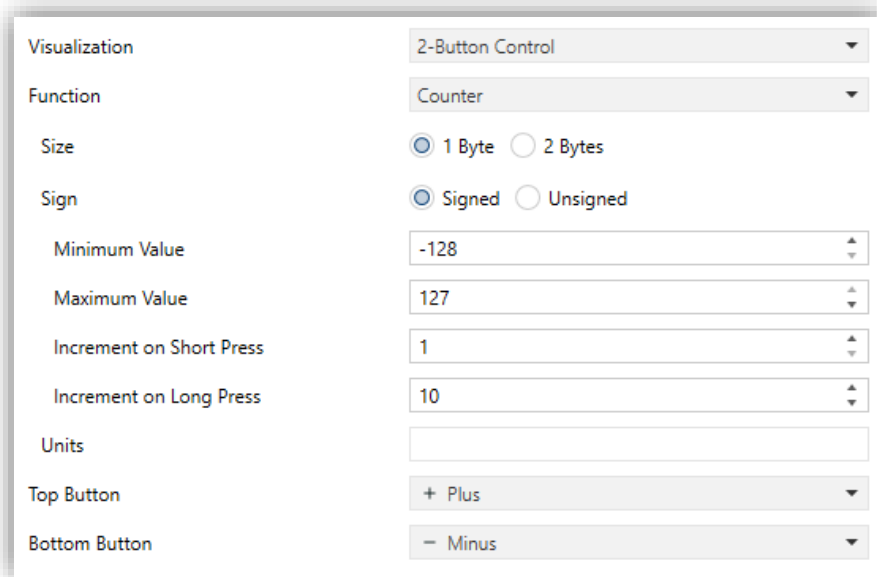

Figure 90. 2-Buttons Control - Numerical Control

The different types of 2-button numerical control available, their configuration options and the objects associated with them are listed in the following table:

Function	Size	Sign	Minimum Value	Maximum Value	Increment on short press	Increment on long press	Related Object
Counter	1 Byte	Signed	[-128...127]	[-128...127]	[1...127]	[1...10...127]	[Ci] 1-Byte Signed Int Indicator [Ci] 1-Byte Signed Int Control
		Unsigned	[0...255]	[0...255]	[1...255]	[1...10...255]	[Ci] 1-Byte Unsigned Int Indicator [Ci] 1-Byte Unsigned Int Control

	2 Byte	Signed	[-32768...32767]	[-32768...32767]	[1...32767]	[1...32767]	[Ci] 2-Byte Signed Int Indicator [Ci] 2-Byte Signed Int Control
		Unsigned	[0...65535]	[0...65535]	[1...65535]	[1...65535]	[Ci] 2-Byte Unsigned Int Indicator [Ci] 2-Byte Unsigned Int Control
Scaling	1 Byte		[0... 100]	[0... 100]	[1...100]	[1... 10...100]	[Ci] Percentage Indicator [Ci] Percentage Control
Float	2 Byte		[-671088.64... ...670433.28]	[-671088.64... ...670433.28]	[0.1...0.5... ...670433.28]	[0.1...1... ...670433.28]	[Ci] 2-Byte Float Indicator [Ci] 2-Byte Float Control

Table 8. Numerical Control 2-Button

- **Decimal Places** [\[0 / 1 / 2\]](#): if the control is set as float, this parameter define the number of decimal places displayed in the box.
- **Units**: permits specifying the measuring units of the displayed value. For percentage indicator, the symbol % always will be displayed as unit.

2.2.2.1.3.5 Enumeration

The box will behave analogously to the case of the switch, however the communication objects (control object “[Ci] Enumeration Control” and the status “[Ci] Enumeration Indicator”) will be 1-byte. Up to six discrete states can be distinguished depending on the value that the status object acquires from the control or receives from the bus.

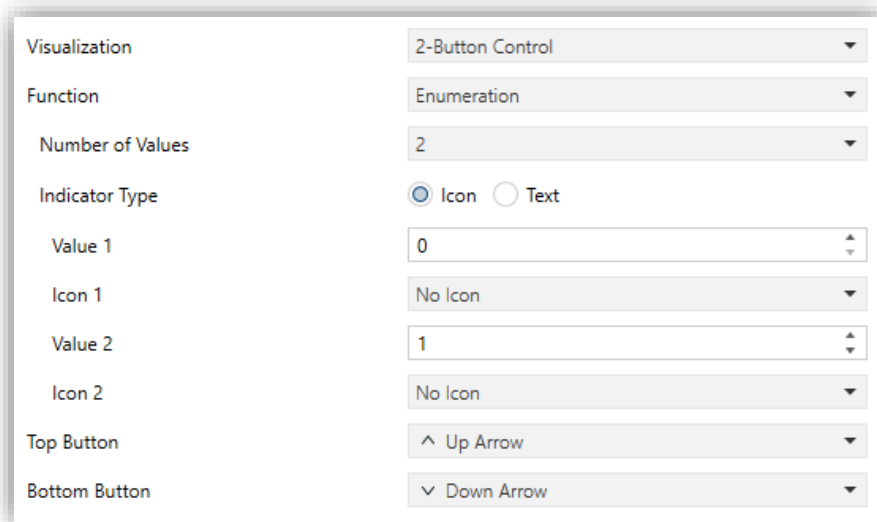

Figure 91. 2-Buttons Control - Enumeration

- **Number of Values** [\[1...2...6\]](#): number of states that will be distinguished. For every distinguished state, the parameter **Value** [\[0...255\]](#) will become available together with the corresponding indicator.
- **Indicator Type** [\[Icon / Text\]](#): allows selecting whether the status indicator which each value is represented will be text type or icon type. As many drop-down lists

of icons or text boxes will be displayed as states have been enabled in the previous parameter.

2.2.2.1.3.6 Two Scene

Analogously to the 1-button scene control, 2-button scene controls allows sending the KNX bus a scene value, however in this case there will be two buttons in the box, each of which can be configured independently.

Visualization	2-Button Control
Function	Two Scenes
Top Scene	1
Action	<input checked="" type="radio"/> Run <input type="radio"/> Run and Save
Object to Use	<input checked="" type="radio"/> General Scene Object <input type="radio"/> Individual Box Scene Object
Bottom Scene	1
Action	<input checked="" type="radio"/> Run <input type="radio"/> Run and Save
Object to Use	<input checked="" type="radio"/> General Scene Object <input type="radio"/> Individual Box Scene Object
Indicator	★ Star
Top Button	▶ Play
Bottom Button	▶ Play

Figure 92. 2-Button Control – Two Scenes

- **Top / Bottom Scene** [[1...64](#)]: value of the scene that will be sent to the bus after pressing on the top and bottom button.
 - **Action** [[Run](#) / [Run and Save](#)]: sets whether the device will only send orders to execute specified scene (after a short press) or if will be possible to send orders to save the scene (after a long press).
 - **Object to Use** [[General Scene Object](#) / [Individual Box Scene Object](#)]: specifies whether the scene value will be sent through the object "[General] Scenes: Send" or through the individual object for each: "[Ci] Top Scene: Send" and/or "[Ci] Bottom Scene: Send".

2.2.2.1.3.7 Shutter

Shutter control permits sending move up and move down ("[Ci] Shutter - Move") or stop ("[Ci] Shutter – Stop/Step") to control a shutter actuator connected to the bus by pressing the buttons in the box. In addition, the box will contain an indicator that will

permanently show, as a percentage, the value of the status object (“[Ci] Shutter Position”).

In case of configuring **Slider** type control, the control value will be sent through the “[Ci] Shutter – Percentage Control” object. In addition, a new “[Ci] Shutter – Move Status” object will appear to indicate to the device whether the shutter is currently moving. If the shutter is in motion, the indicator icon will change and become clickable, thus allowing the shutter movement to stop.

Title	<input type="text"/>	<input type="checkbox"/> Different Title for ETS
Visualisation	2-Button Control	
Function	Shutter	
Slider	<input type="checkbox"/>	
Type	<input checked="" type="radio"/> Standard <input type="radio"/> Hold & Release	
Show Percentage Indicator	<input checked="" type="checkbox"/>	
State Icons		
Shutter Open (0%)	Shutter Up	
Shutter Half-open (1-99%)	Shutter Middle	
Shutter Closed (100%)	Shutter Down	
Top Button	Up Arrow	
Bottom Button	Down Arrow	
Log & Graph	Disable	
Protect	<input checked="" type="radio"/> No <input type="radio"/> Yes	

Figure 93. 2-Buttons Control - Shutter

- **Type:** set the desired behaviour for the buttons:
 - [[Standard](#)]: a long press will make the device send to the KNX bus an order to start moving the shutter (upwards or downwards, with the top or bottom button respectively), while a short press will make it send a stop order (or step up / step down).
 - [[Hold & Release](#)]: as soon as the button is held, the device will send the KNX bus an order to start moving the shutter (upwards or downwards, with the top or bottom button respectively). Once the button is released, it will send an order to stop the shutter.
- **Show Percentage indicator** [[disabled](#) / [enabled](#)]: enables or disables the shutter position indicator (in percentage) in the box.

Additionally, the shutter control will have the percentage object "[Ci] Shutter Positioning (Only Schedulers and Macros)" which will be used by schedulers and macros for a precise regulation of the shutter.

2.2.2.1.3.8 Dimmer

The light control function permits making use of the two buttons in the box to send orders to a light dimmer, either through a binary object or through a 4-bit object. Moreover, the box will permanently display the current value of the dimming status object ("[Ci] Light – Dimming Indicator"), which needs to be linked to the analogous object from the dimmer (as it does not get automatically updated on button presses).

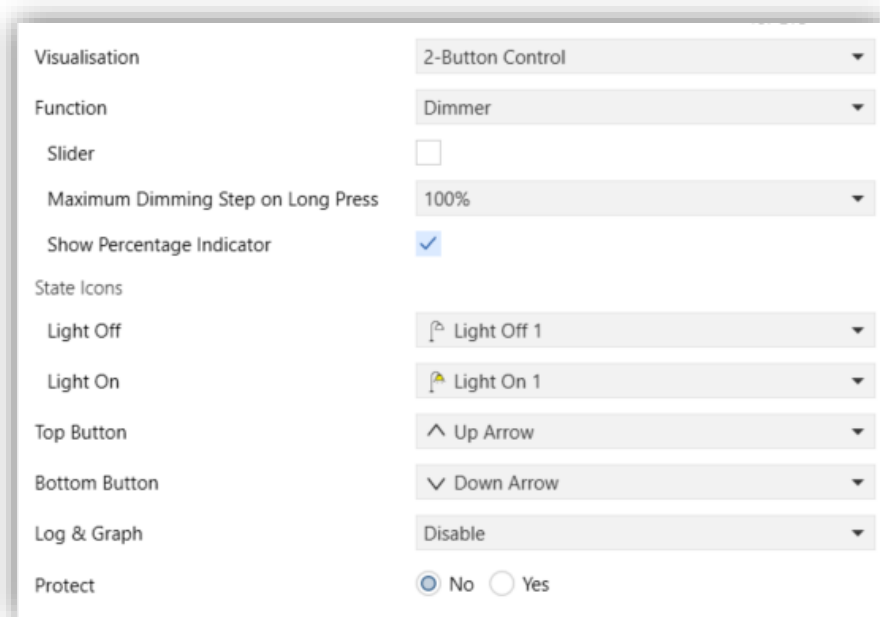

Figure 94. 2-Buttons Control - Dimmer

The parameters available are:

- **Slider** [*disabled / enabled*]: enables the option to control the checkbox with slider instead of buttons.
- **Maximum Dimming Step on Long Press** [*100% / 50% / 25% / 12.5% / 6.25% / 3.1% / 1.5%*]: sets the increase or decrease in the light level that will be requested, via object "[Ci] Light – Dimming", from the dimmer with each long press on the top or bottom button respectively.

After a short press on the top button the value "1" will be sent through the "[Ci] Light - On/Off" binary object, while a short press on the bottom button will trigger the sending of the value "0".

- **Show Percentage Indicator** [*disabled* / *enabled*]: enables or disables the shutter status indicator in the box.

Note: *most light dimmers implement light step dimming progressively (i.e., sending a dimmer a step order of 25% typically does not imply that the light level is suddenly incremented/decremented by 25%, but a progressive increment or decrement of the light level by 25% which is in fact interrupted if a stop order arrives (such order is sent by the touchscreen when the user releases the button). Due to this behaviour, it is advised to parameterise dimming steps of 100%, so that the user can perform a complete dimming (from totally off to totally on, or vice versa) or a partial dimming by simply holding the button and then releasing it as soon as he gets the desired light level, therefore with no need of performing successive long presses for regulations greater than the parameterised step.*

Additionally, the dimmer control will have the 1-byte object "**[Ci] Precise Dimming (Only Schedulers and Macros)**" which will be used by schedulers and macros for a precise lighting control.

In case of configuring it as a **Slider**, the control will be done through the object "**[Ci] Light – 1-Byte Percentage Control**", allowing also to send an on/off command with a click on the central icon of the box "**[Ci] Light – Switch Control**". The following parameters will be displayed:

Slider	<input checked="" type="checkbox"/>
Minimum Increment	<input type="text" value="1"/> %
Colour Temperature	<input checked="" type="checkbox"/>
Minimum Dimming Value	<input type="text" value="2500"/> °K
Maximum Dimming Value	<input type="text" value="6500"/> °K
Minimum Increment	<input type="text" value="100"/> °K
Show Percentage Indicator	<input checked="" type="checkbox"/>

Figure 95. Dimming control with slider

- **Minimum Increment** [*1...100*] [%]: step value that the slider will have.
- **Colour Temperature** [*disabled* / *enabled*]: enables an additional slider to control the colour temperature through the objects "**[Ci] Light – Colour Temperature Control**" and "**[Ci] Light – Colour Temperature Status**".

- **Minimum Dimming Value** [1000...2500...20000] [K]: sets the minimum value that can be reached by the slider.
- **Maximum Dimming Value** [1000...6500...20000] [K]: sets the maximum value that can be reached by the slider.
- **Minimum Increment** [1...100...1000] [K]: step value that the slider will have.

2.2.2.1.3.9 Room State

Configuring with this function the box, controlling the states of the room will be possible, as well as show the associated pop-up. Thus, pressing on the top button will cause the room status to switch between *normal* and *Make Up Room*, while with the bottom button, the state will be switch between *normal* and *Do Not Disturb*.

Visualization	2-Button Control
Function	Room State
Show Pop-Up When Activating Normal State	No
Show Pop-Up When Activating MUR	No
Show Pop-Up When Activating DND	No
Icon "Normal"	Room Normal
Icon "Make Up Room"	Make Up Room
Icon "Do Not Disturb"	Do Not Disturb
MUR Button	Make Up Room
DND Button	Do Not Disturb

Figure 96. 2-Buttons Control - Room State

- **Show Pop-Up When Activating Normal State** [[No](#) / [Pop-Up 1](#) / ... / [Pop-Up 6](#)]: allows to select the pop-up to be displayed when *normal* mode is activated.
- **Show Pop-Up When Activating MUR** [[No](#) / [Pop-Up 1](#) / ... / [Pop-Up 6](#)]: allows to select the pop-up to be displayed when *Make Up Room* mode is activated.
- **Show Pop-Up When Activating DND** [[No](#) / [Pop-Up 1](#) / ... / [Pop-Up 6](#)]: allows to select the pop-up to be displayed when *Do Not Disturb* mode is activated.

Note: the pop-ups selected must be activated (see section 2.1.18.2).

This control will have associated a dedicated object for the indicator (“**[Ci] Room State Indicator**”), which is automatically updated after the control order is sent and when values are received from the bus.

2.2.2.1.4 CLIMATE CONTROL

This category covers a set of functions related to the climate control. The available options for **Function** (and for the dependent parameters) are as follows:

2.2.2.1.4.1 *Temperature Setpoint*

This function permits controlling the temperature setpoint of an external thermostat by means of a two-button box and of the parameters enabled to that effect: “**[Ci] (Climate) Setpoint Temperature Control**” for the control and “**[Ci] (Climate) Setpoint Temperature Indicator**” for the status. It is also possible to enable a real temperature indicator that will be updated through the object “**[Ci] (Climate) Real Temperature Indicator**”.

The box itself will permanently reflect the value in °C o °F of the status object, whose value gets automatically updated after sending control orders (that is, after pressing the buttons), being even possible to receive values from the bus, for example, from the corresponding setpoint status object from the external thermostat.

Therefore, after every press on the temperature increment button, the bus will be sent (through the control object) a certain value, progressively increased on every button press until the parameterisable maximum setpoint value has been reached. Analogously, after every press on the temperature decrement button, the bus will be sent a progressively decreased value until the parameterisable minimum setpoint value has been reached.

Visualisation	Climate Control
Function	Temperature Setpoint
Slider	<input type="checkbox"/>
Button to Change between °C and °F	<input type="checkbox"/>
Include Plus Sign before Positive Numbers	<input type="checkbox"/>
Indicator Type	Just Setpoint Temperature
Different Limits for Cool/Heat Mode	<input type="checkbox"/>
Minimum Value	10 °C
Maximum Value	30 °C
Increment on Short Press	0.5 °C
Increment on Long Press	1 °C
Top Button	+ Plus
Bottom Button	- Minus
Log & Graph	Disable
Protect	<input checked="" type="radio"/> No <input type="radio"/> Yes

Figure 97. Climate Control – Temperature Setpoint

The parameters available are:

- **Slider** [*disabled / enabled*]: enables the option to control the checkbox with slider instead of buttons.
- **Button to Change between °C and °F** [*disabled / enabled*]: enables a control that allows the temperature scale to be changed from the box itself.
- **Include Plus Sign before Positive Numbers** [*disabled / enabled*]: adds the '+' sign before positive temperature values.
- **Indicator Type:**
 - [*Just Setpoint Temperature*]: only the setpoint temperature will be displayed.
 - [*Setpoint is Main and Real is Secondary*]: this option shows two temperatures at the same time. The real temperature will be displayed below the setpoint temperature in a smaller font size and accompanied by a house icon.
 - [*Setpoint is Secondary and Real is Main*]: this option shows two temperatures at the same time. The setpoint temperature will be displayed below the real temperature in a smaller font size and accompanied by a thermometer icon.



Figure 98. Setpoint Temperature with different indicator types

- **Different Limits for Cool/Heat Mode** [[disabled](#) / [enabled](#)]: sets a different upper and lower limit for cool mode and heat mode.
- **Minimum Value** [[-99...10...199](#)]: minimum value than can be reached by the control after a number of presses on the bottom button. If the parameter **Different Limits for Cool/Heat Mode** is enabled, this parameter will be duplicated, one for cooling mode and one for heating mode.
- **Maximum Value** [[-99...30...199](#)]: maximum value than can be reached by the control after a number of presses on the top button. If the parameter **Different Limits for Cool/Heat Mode** is enabled, this parameter will be duplicated, one for cooling mode and one for heating mode.
- **Increment on Short Press** [[0.1...0.5...10](#)]: sets the increase or decrease step to be applied to the current value on every short press over the top or bottom buttons, respectively.
- **Increment on Long Press** [[0.1...1...10](#)]: sets the increase or decrease step to be applied to the current value on every long press over the top or bottom buttons, respectively.

Note: Long and short increments are applied in °C regardless of the scale used.

2.2.2.1.4.2 Mode

This function turns the box into a climate mode control.

When this type of mode control is assigned to the box, two communication objects are enabled: the “[Ci] (Climate) Mode Control” control object, and the “[Ci] (Climate) Mode Indicator” status object. Depending on the mode selected by the user, the control object will be sent to the bus a certain value, after which the box will display the icon that corresponds to the new mode.

Two mode control types are possible: Heat / Cool control type and the Extended (HVAC) control type.

● Mode Type:

- [[Heat/Cool](#)]: Selecting this type of mode control turns the box into a 2-button control one of which will activate the Heat mode, while the other one will activate the Cool mode. A centered indicator will reflect, as an icon, the currently active mode.

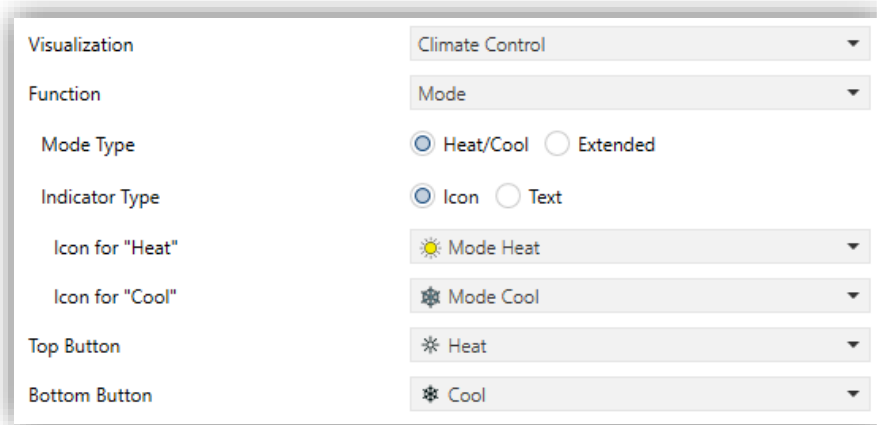

Figure 99. Climate Control - Heat/Cool Mode

When the user activates the Cool mode, the device will send the value "0" through the control object, while on the activation of the Heat mode the value "1" will be sent. Moreover, the box will automatically commute between one icon and the other every time the user executes a mode change, and also on the reception of a new value (from the bus) through the status object.

- [[Extended](#)]: Selecting this type of mode control turns the box into a 2-button control, which permit sequentially commuting among the different HVAC climate modes. A centred indicator will reflect, as an icon, the currently active mode.

Up to five modes [[Auto / Heat / Cool / Fan / Dry](#)] are available, each of which can be enabled/disabled in ETS by means of the proper checkbox, which permits setting which of all the five extended modes will be included into the sequential scrolling implemented by the buttons.

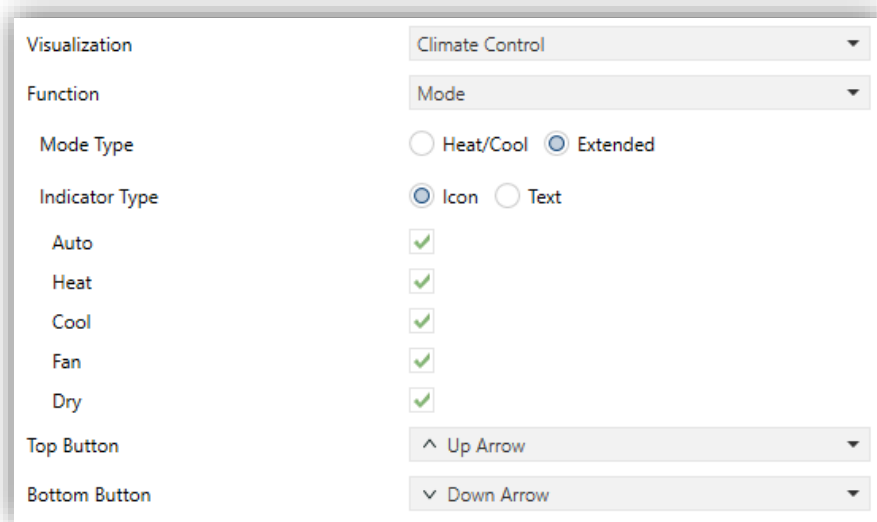

Figure 100. Climate Control - Extended Mode.

Depending on the mode selected by the user, the control object will be sent to the bus a certain value (see Table 9). The box will display the icon that corresponds to the new mode. Additionally, if the status object receives from the bus a value that represents any of the modes, the box will adopt the corresponding icon, while if an unrecognised value is received, no icon will be shown.

Mode	Value sent
Auto	0 (0x00)
Heat	1 (0x01)
Cool	3 (0x03)
Fan	9 (0x09)
Dry	14 (0x0E)

Table 9. HVAC Mode vs. Object Value

- **Indicator Type** [*Icon / Text*]: enables to select whether the status indicator which each value is represented will be text type or icon type. As many drop-down lists of icons or text boxes will be displayed as modes have been enabled.

2.2.2.1.4.3 Fan Control

This function implements a 2-button (increase / decrease) fan control, as well as an icon indicator.

When this function is assigned to the box, a control object and a 1-byte status object (“**[Ci] (Climate) Fan Indicator**”) are enabled. The status object (which needs to be linked

to the status object of the fan actuator) will express, as a percentage, the value of the current fan level, which will be represented with a variable icon on the box.

Visualization	Climate Control
Function	Fan
Speed Levels	1
Control Type	1 bit (Decrease/Increase)
Cyclical	<input type="checkbox"/>
Auto Mode	<input type="checkbox"/>
Allow Speed 0	<input type="checkbox"/>
Top Button	+ Plus
Bottom Button	- Minus

Figure 101. Climate Control - Fan

- **Speed Levels** [1...5]: sets how many speed levels will be available in the control. 1 to 5 levels.
- **Control Type**: sets the type of the communication objects that will control the fan level.
 - [1 bit (decrease/increase)]: orders of speed increase/decrease are sent through the one-bit object “[Ci] (Climate) Fan Control (1-Bit)”.
 - [Scaling]: scaling values are sent through the one-byte object “[Ci] (Climate) Fan Control (scaling)”.
 - [Enumeration]: integer values are sent through the one-byte object “[Ci] (Climate) Fan Control (enumeration)”.
- **Cyclical** [disabled / enabled]: sets whether scrolling through the speed levels is circular or not. If checked, an increase order in the maximum level switches to the minimum and vice versa (in the minimum level a decrease order switches to the maximum). In case of having **Control Type: 1 bit (Decrease/Increase)**, this parameter cannot be enabled.
- **Auto Mode** [disabled / enabled]: sets whether the fan Auto mode will be available or not. If checked, the following parameters are also shown.
 - **Dedicated Object for Auto Mode** [disabled / enabled]: sets how the Auto mode should be activated. In the absence of a dedicated object, the Auto fan mode will be activated by switching to fan level 0.

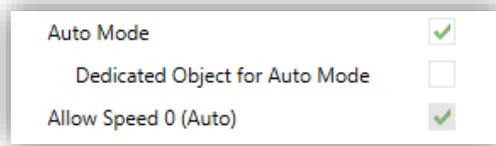

Figure 102. Fan Control – Auto Mode.

In case to be disabled (supposing that **Speed Levels** has been set to “3”), the fan levels that can be navigated through short presses are:

Auto (0)	Minimum	Medium	Maximum
------------	---------	--------	---------

On the other hand, marking the checkbox enables the one-bit object “[Ci] (Climate) Fan Control - Auto mode”, which will trigger the Auto mode when it receives the value “1” or “0”, depending on the subsequent parameter **Value to Set the Auto Mode** [[Send 0 / Send 1](#)].

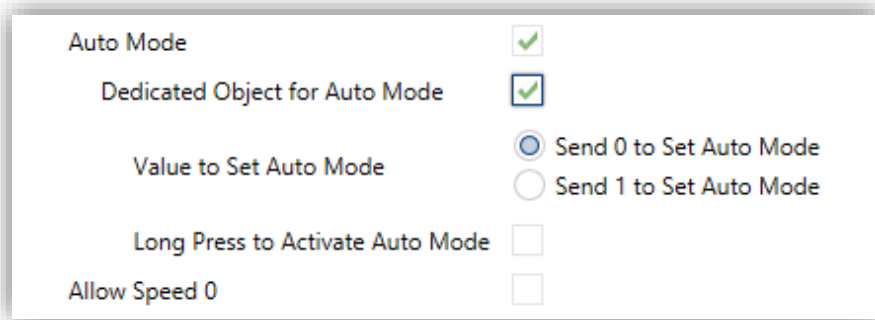

Figure 103. Fan Control – Dedicated Object for Auto Mode

However, in this case the Auto mode can be activated in two ways (and mutually exclusive):

- By short press: Auto mode can be reached as a further level above the maximum one. In this case the fan levels activated by short presses are (note that **speed 0 is optional**):

(0)	Minimum	Medium	Maximum	Auto
-------	---------	--------	---------	------

- By long press on any of the buttons of the control (requires checking **Long Press to Activate Auto Mode** [[disabled / enabled](#)]). A further long press deactivates back the Auto mode

In this case the fan levels reachable through short presses are (**speed 0 is optional**):

(0)	Minimum	Medium	Maximum
-------	---------	--------	---------

Here, the Auto mode is only activated by long press.

- **Allow speed 0:** sets whether the speed level 0 will be present or not. When the **Auto Mode without a dedicated object** has been configured, this option will be necessarily activated.

2.2.2.1.4.4 Special Mode

Boxes configured as special mode controls include two buttons that let the user sequentially commute between the different special climate modes, as well as an icon indicator that will adopt an aspect or another depending on the currently active special mode.

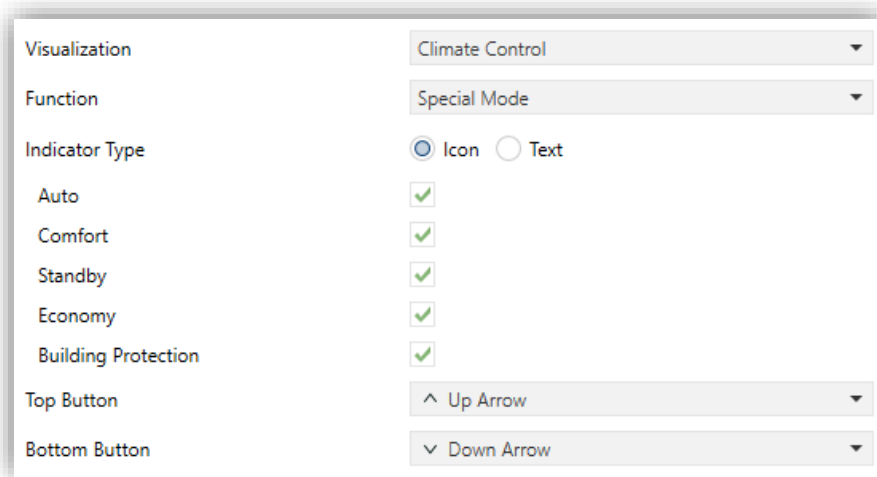

Figure 104. Climate Control - Special Mode

When this function is assigned to the box, two 1-byte objects (“**[Ci] (Climate) Special Mode Control**” as the control object, and “**[Ci] Special Mode Indicator**” as the status object) will be enabled. The former will be sending the bus the value that corresponds to the mode that the user selects by touching the buttons (see Table 10), while the status object (which can receive values from the bus although it gets self-updated as well on button presses) will determine the indicative icon represented in the box at any time. If this object receives an unrecognised value from the bus, no icon will be displayed in the indicator.

Special Mode	Icon	Object Value
Comfort		1 (0x001)





Standby		2 (0x002)
Economy		3 (0x003)
Protection		4 (0x004)
Auto Mode		5 (0x005)

Table 10. Special Modes vs. Icon vs. Object Value

- **Indicator Type** [[Icon](#) / [Text](#)]: allows selecting whether the status indicator which each value is represented will be text type or icon type. If “[Text](#)” is selected, as many text boxes will be displayed as modes have been enabled.

2.2.2.1.5 OTHER

2.2.2.1.5.1 RGB Control

This function is intended for sending orders to three-colour LED light regulators.

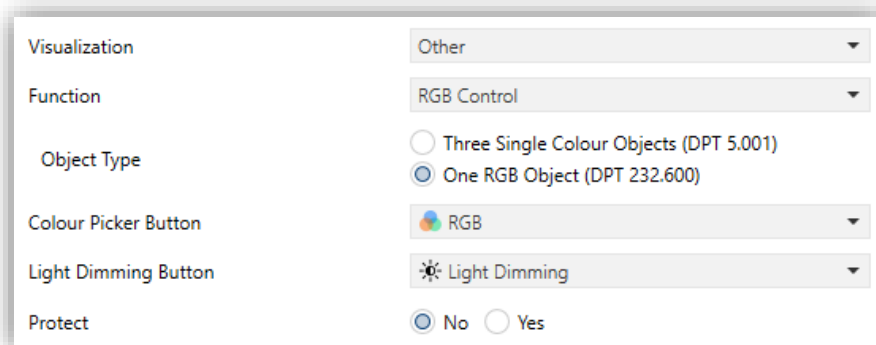

Figure 105. RGB Control

When the function is assigned to the box, the following parameter come up:

- **Object Type** [[Three Single Colour Objects \(DPT 5.001\)](#) / [One RGB Object \(DPT 232.600\)](#)]: permits selecting what type of object will be used for controlling the light level of the RGB channels.
 - “[Three Single Colour Objects \(DPT 5.001\)](#)”: three 1-byte objects (“**[Ci] Red Channel**”, “**[Ci] Green Channel**” and “**[Ci] Blue Channel**”) will be enabled, which can send orders and receive statuses.

- “One RGB Object (DPT 232.600)”: only one 3-byte object will be enabled (“**[Ci] RGB Color**”). The light levels of the three channels are sent (and received) concatenated into the above 3-byte object.

Regarding the RGB control boxes themselves, a central label will permanently show the colour and current light level (which is determined by the channel with the highest current light level). This **indicator** gets updated automatically as the user interacts with the box, but is also conditioned by the values received from the bus through the already described objects.

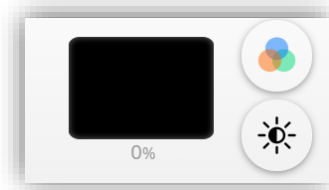

Figure 106. RGB (Box)

Moreover, two buttons can be found in the box:

- **Short-pressing** on the lower button send on/off control commands via the "**[Ci] RGB - On/Off**" object. **Long-pressing** it, on the other hand, will make the device send a 4-bit dimming order through object "**[Bi] Light Dimming Control**", analogously as the light dimming control.
- The upper button, when pressed, launches a pop-up containing a **colour wheel** that permits the selection of a light level for every channel. Within this, there is an area to choose the colour and a slider to adjust the intensity of the colour.



Figure 107. RGB/RGBW Colour Selector

2.2.2.1.5.2 RGBW Control

The RGBW control is **analogous to the above** RGB control, although it also lets controlling a specific **fourth channel** for white (“**[Pn][Bi] White Channel**”).

It also has the particularity of being able to choose a colour object.

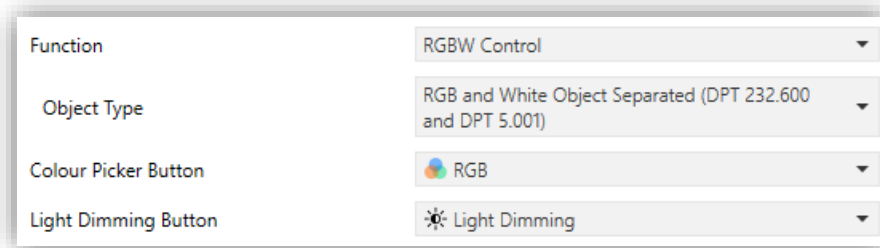

Figure 108. RGBW Control

- **Object Type** [Four Single Colour Objects (DPT 5.001) / RGB and White Objects Separated (DPT 232.600 and DPT 5.001) / One RGBW Object (DPT 251.600)]: permits selecting what type of object will be used for controlling the light level of the RGBW channels.
 - “Four Single Colour Objects (DPT 5.001)”: 1-byte object is enabled for each channel (“**[Ci] RGBW – Red Channel**”, “**[Ci] RGBW – Green Channel**”, “**[Ci] RGBW – Blue Channel**” and “**[Ci] RGBW – White Channel**”).
 - “RGB and White Objects Separated (DPT 232.600 and DPT 5.001)”: two objects will be enabled, one 3-byte object analogous to RGB (“**[Pn][Bi] RGB Color**”) and a 1-byte object for de white channel (“**[Ci] Red Channel**”).
 - “One RGBW Object (DPT 251.600)”: a 6-bytes object will be enabled: “**[Pn][Bi] RGBW Color**” through which the light levels of the four channels are sent and received concatenated.

2.2.2.1.5.3 Page Direct Link

This control allows a shortcut to the page indicated by parameter. To configure a box as a page direct link type control, the following parameter must be set in addition to the icon:

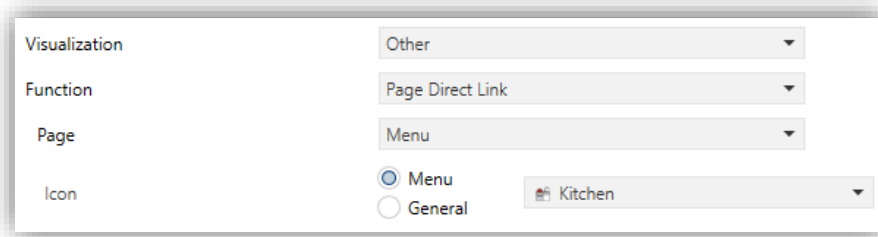

Figure 109. Page Direct Link

- **Page** [Menu / Configuration / Page 1 / ... / Page 12]: page that will be accessed.

2.2.2.1.5.4 Alarm

Boxes configured as alarms perform user warnings on anomalous events. For this purpose, boxes of this type are related to the binary object “[Ci] Alarm Trigger” that permits receiving alarm messages from the bus, thus making the touchscreen emit a **continuous beep** while the screen **light blinks**. In addition, the screen will automatically browse to the page containing the alarm box that has been triggered and pop-ups that were open will be deactivated.

Notes:

- *If the touchscreen is locked, the lock pop-up will not be closed, but the alarms will be silenced with a press on the screen.*
- *If the page where the alarm is located is protected, the display will not automatically access that page.*

The **blinking warning icon** shows that the alarm is active and not confirmed. This icon will also appear in the upper right corner of the button of the page where the alarm is located.

When an alarm has been activated, there are two different ways to silence the sound notification and the luminous blinking of the display.

- **Pressing the ‘Home’ button:** it will silence the sound notification and end the flashing, but it will not confirm the alarm. The alarm box icon will continue blinking.

- Press the 'OK' button in the alarm box: this will silence the sound notification, end the flashing light, confirm the alarm, and cause the icon to stop blinking. When this button is pressed, the binary object "[Ci] Alarm Confirmation" with the value "1" will be sent through the bus. If this object receives from the bus the value "1", the alarm will also be confirmed, having the same effects.

The alarm will definitely become inactive once it has been confirmed and, in addition, once the "[Ci] Alarm Trigger" object goes back to the "no alarm" state (the order of these two events is irrelevant), after which the box icon and the page icon will finally turn off.

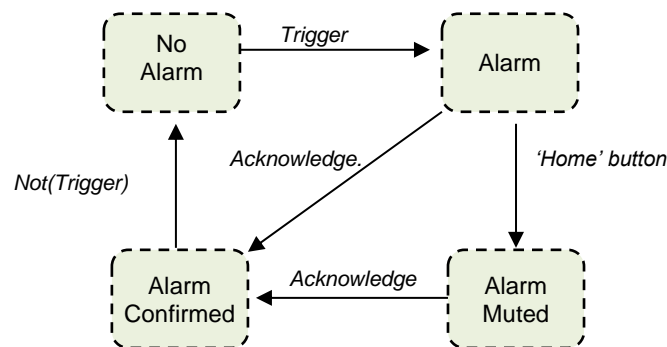

Figure 110. Alarm state diagram (case of confirmation previous to the alarm end)

There is also the possibility of **periodically monitoring** the status of the trigger object, for situations where this object is periodically received from the bus. This will let the touchscreen automatically assume the alarm situation if the "no alarm" value does not get sent through the trigger object after a certain time, for example upon failures of the transmitter. The maximum time window can be defined by parameter.

It is also possible to set the duration of the visual and audible warning of the alarm. Consequently, alarm boxes permit configuring the following parameters:

Visualization	Other
Function	Alarm
Trigger	<input type="radio"/> 0 <input checked="" type="radio"/> 1
Periodic Monitoring	<input checked="" type="radio"/> No <input type="radio"/> Yes
Stop Visual and Audible Warning	<input checked="" type="checkbox"/>
Length of the Warning (0 = Silent Alarm)	30
	s

Figure 111. Alarm

- **Trigger** [0 / 1]: defines the value that will trigger the alarm (“0” or “1”; it is “1” by default), i.e., the value that, when received through “[Ci] Alarm Trigger”, should be interpreted as an alarm situation. Implicitly, this parameter also defines the inverse “no alarm” value.
- **Periodic Monitoring** [No / Yes]: activates or deactivates periodic monitoring of the alarm trigger object. When activated, the following parameter appears:
 - **Cycle Time** [30...65535] [s] [1...255] [min / h]: sets the maximum accepted time space without receiving the “no alarm” value before the touchscreen adopts the alarm situation.
- **Stop Visual and Audible Warning** [disabled / enabled]: When activated, the following parameter appears:
 - **Length of the Warning (0 = Silent Alarm)** [0...30...65535] [s / min / h]: set the duration of the visual and audible warning. After this time the alarm will still be unconfirmed but the visual and audible warning will have ceased.

2.2.2.1.5.5 Video Intercom

Note: Video Intercom functionality requires a license installation. If not, even being possible to configure it from ETS, its use will not be accessible.

This control enables access to the call log (bottom button) and to the preview of the images of the configured video intercoms (top button).

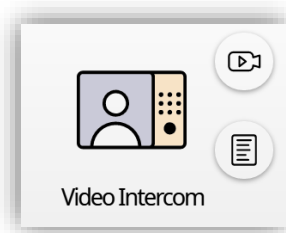

Figure 112. Video intercom (Box)

From the preview window, the video intercom configured by default will be opened and it will be possible to navigate between the different parameterised video intercoms, showing the image from the external unit's camera.

The call log will be common to all configured video intercom.

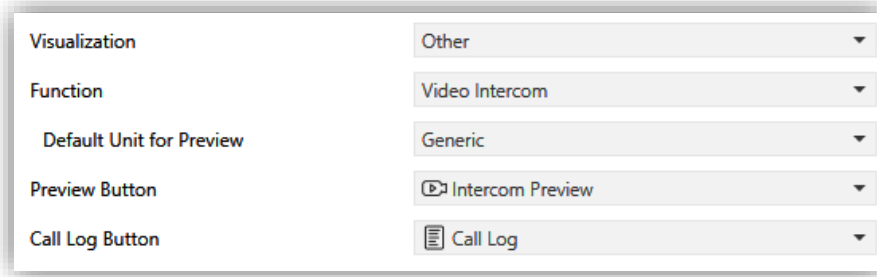

Figure 113. Video Intercom box

When the function is assigned to the box, the following parameter come up:

- **Default Unit for Preview** [[Generic / 1 / ... / 20](#)]: external unit displayed by default when preview window is opened.

For more detailed information about the functions and controls of the different dialogues of video intercom functionalities, please refer to [ANNEX I. Video Intercom Operation](#).

2.2.2.1.5.6 Internal Call

Note: Internal Call functionality requires a license installation. If not, even being possible to configure it from ETS, its use will not be accessible.

This control enables access to the contacts list or number keypad in order to start a call (top button) and to the internal calls log (bottom button):

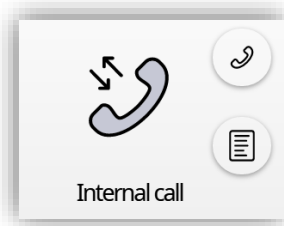

Figure 114. Internal Call (Box)

When the function is assigned to the box, the following parameter come up:

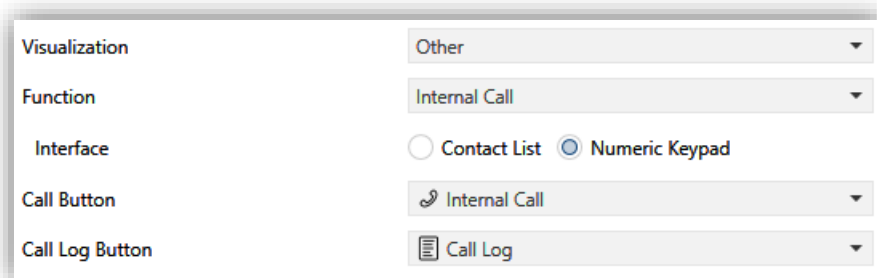

Figure 115. Internal call box

- **Interface** [[Contact List / Numeric Keypad](#)]: dialog type for internal calls box. This parameter is only available if **Import contacts** “from web” has been selected in the general screen of “Internal Calls” (see section 2.1.16.2).
- [[Contact List](#)]: shows a list of contacts and two arrows to go through it.

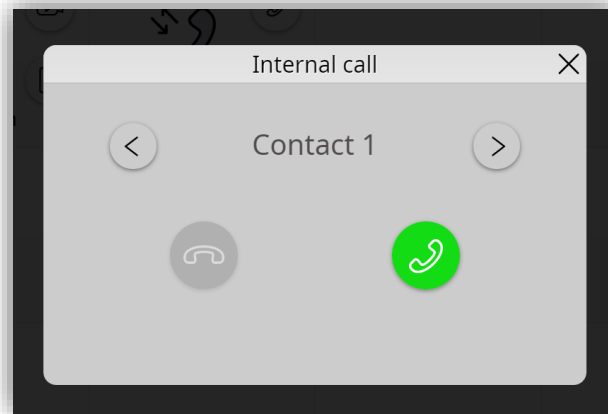

Figure 116. Contacts list

Note: The interface in Figure 116 will also be displayed if the **Import contacts** “from web” option (see section 2.1.16.2) is not enabled and the contact list is configured in ETS.

- [[Numeric Keypad](#)]: shows a keypad to enter the code number associated with the contact intended to call.

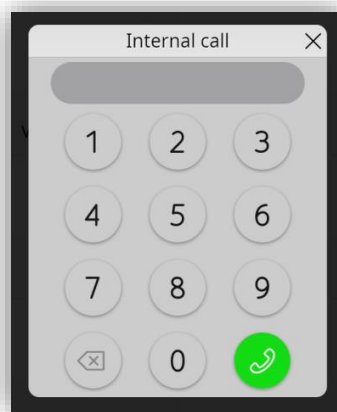

Figure 117. Numeric Keypad

For more detailed information about the functions and controls of the different dialogues of internal calls functionalities, please refer to [ANNEX II. Internal Call Operation](#).

2.2.2.1.5.7 Chronothermostat

This control let the final user schedule the timed sending of **temperature setpoints orders** (preceded by switch-on orders) or **switch-off orders** to a thermostat through the objects “[Ci] Chronothermostat: On/Off” and “[Ci] Chronothermostat: Temperature”.

To that end, setting the following parameters is necessary:

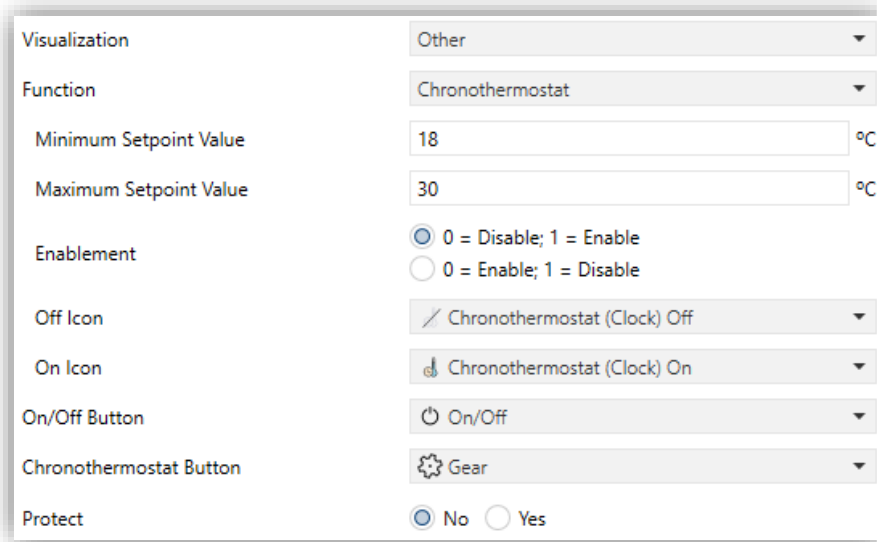

Visualization	Other
Function	Chronothermostat
Minimum Setpoint Value	18 °C
Maximum Setpoint Value	30 °C
Enablement	<input checked="" type="radio"/> 0 = Disable; 1 = Enable <input type="radio"/> 0 = Enable; 1 = Disable
Off Icon	Chronothermostat (Clock) Off
On Icon	Chronothermostat (Clock) On
On/Off Button	On/Off
Chronothermostat Button	Gear
Protect	<input checked="" type="radio"/> No <input type="radio"/> Yes

Figure 118. Chronothermostat

- **Minimum Setpoint Value** [-99 ... 18 ... 199][°C]: minimum setpoint value that the user can be set on the chronothermostat panel (see Figure 120).
- **Maximum Setpoint Value** [-99 ... 30 ... 199][°C]: maximum setpoint value that the user can be set on the chronothermostat panel (see Figure 120).
- **Enablement** [0 = Disable; 1 = Enable / 0 = Enable; 1 = Disable]: selects the polarity of the control object “[Ci] Chronothermostat: Enable”, which will enable or disable the chronothermostat analogously as from the on-screen switch button of the box (see Figure 119). The box configured as a chronothermostat control looks as follows:

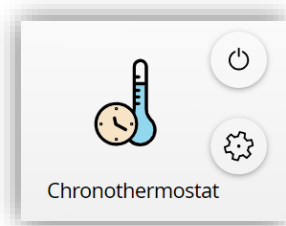

Figure 119. Chronothermostat box

The top button will enable the **chronothermostat to be switched on or off**, i.e. to resume or stop the programmed sending. The **programming of the timed actions** will be performed through the following pop-up window, visible by clicking on the bottom button:

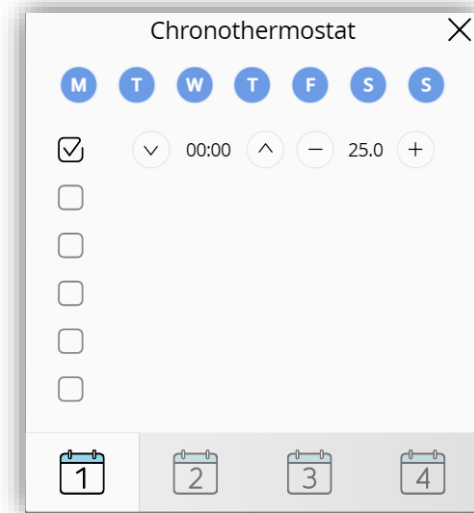

Figure 120. Chronothermostat panel

Each box configured as a chrono-thermostat contains **four pages** with **six customisable timers** each, being possible for the user to configure up to 24 timed actions.

For each of the six timed actions of each page it is necessary to select the **days of the week** on which the action should be performed, as well as the specific **time of day** (the first day of the week will depend on the parameterisation of screen Locale; see section 2.1.3). After that, the user should select the **temperature setpoint** that will be sent.

Instead of a temperature setpoint, it is also possible to send a **switch-off** order to the thermostat. In such case, the user must successively press on the above control until one of the range limits is reached, after which the word **“OFF”** will show on the screen instead of a temperature value.

2.2.2.1.5.8 Scheduler

This control allows access to the general scheduler panel. To do so, it is necessary to enable this functionality in the configuration tab (see section 2.1.2).

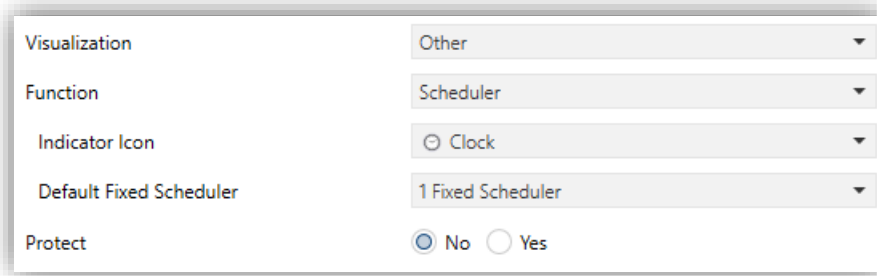

Figure 121. Scheduler

When the function is assigned to the box, the following parameter come up:

- **Default Fixed Scheduler** [*1 Fixed Scheduler / ... / 30 Fixed Scheduler*]: defines which scheduler should be opened by default when accessing the general scheduler panel from this box.

2.2.2.1.5.9 Macro

This control configures the sending of up to **30 orders** sequentially, establishing a delay between one order and another, defined in seconds.

The box configured as **Macro** looks as follows:

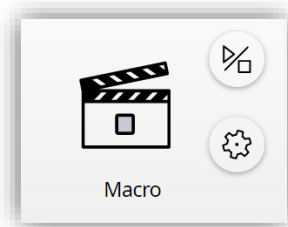

Figure 122. Macro box

The **upper button** star/stop the macro and **lower button** open the macro configuration panel. Within this panel, the actions to be executed with the delay configured for each action are displayed in order.

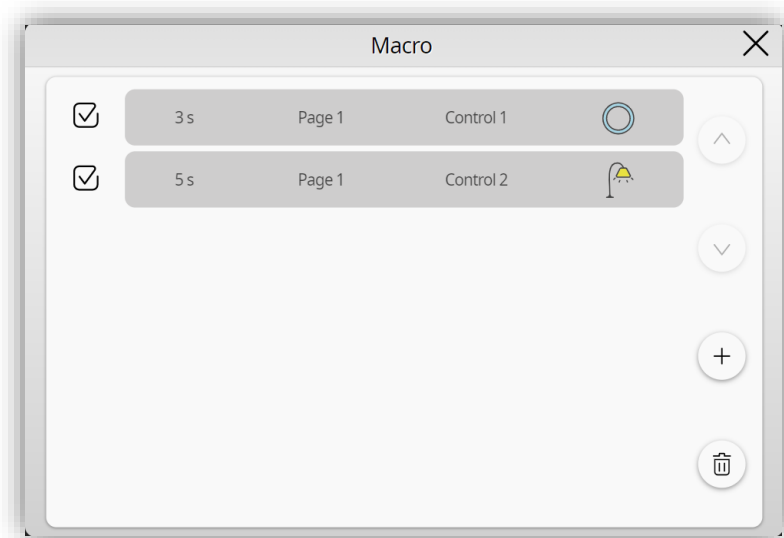

Figure 123. Macro configuration panel

Macro configuration is very similar to schedulers configuration (see section 2.1.7) with some minor differences:

- The time field is replaced by a **delay** to trigger the action. This delay starts counting from when the previous action was triggered or from when the macro started in case it is the first action.
- It is possible to **reorder** the actions by long pressing on the action to be moved (while out of edit mode). After the long press, the action will be marked in blue and it is possible scroll the action through the list. Once the action has been placed, it will be necessary to press the validate button or close the panel to save the changes.

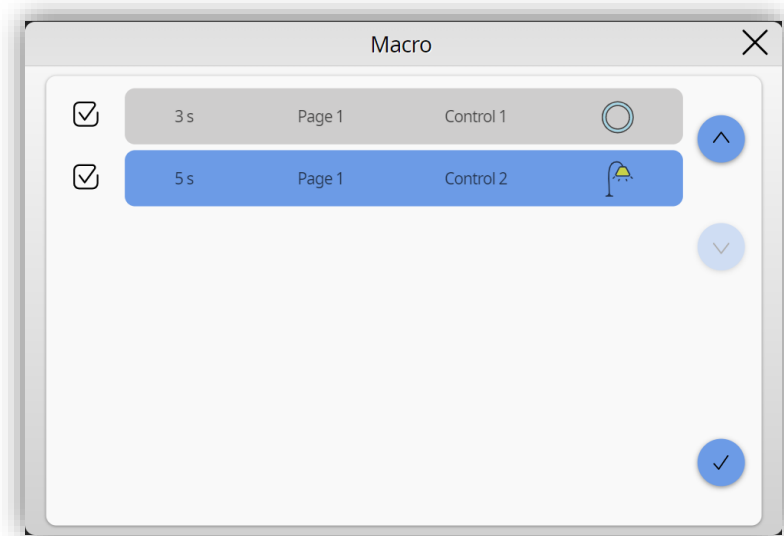

Figure 124. Reordering of actions (Macros)

Note: within a macro it is only possible to configure actions with a **security level equal to or lower** than the security level of the box.

When configuring this control in ETS, the following parameters are displayed:

Visualization	Other
Function	Macro
Trigger: Binary Object	<input checked="" type="checkbox"/>
Value	<input type="radio"/> 0 <input checked="" type="radio"/> 1
Trigger: Scene Object	<input type="checkbox"/>
Icon: Stopped	Clapperboard Stop
Icon: Playing	Clapperboard Play
Send Object when Macro Starts	Disabled
Top Button	Play/Stop
Bottom Button	Gear
Protect	<input checked="" type="radio"/> No <input type="radio"/> Yes

Figure 125. Macro

- **Trigger: Binary Object** [[enabled](#)]: runs/stops the macro through the object “[Ci] Macro: Trigger”.
 - **Value** [[0/1](#)]: polarity of the binary trigger object.
- **Trigger: Scene Object** [[disabled](#) / [enabled](#)]: runs/stops the macro through the object “[General] Scenes: Receive”. When enabled, the following parameters are displayed:
 - **Scene to start (0 = Disabled)** [[0...64](#)]: scene to run the macro.
 - **Scene to stop (0 = Disabled)** [[0...64](#)]: scene to stop the macro.
- **Send Object when Macro Starts** [[Disabled](#) / [Binary Value](#) / [Scene](#)]: sets how to notify that the macro has started.
 - [Binary Value](#): it is notified by the object “[Ci] Macro: Notification”. It shall be possible to choose the polarity of the object via the parameter **Value** [[0/1](#)].
 - When [Scene](#) option is chosen, the following parameters will appear:
 - **Scene Number** [[1...64](#)]: scene sent when macro starts.

- **Scene Object** [[General Scene Object](#) / [Individual Box Scene Object](#)]: sets the object through which the scene is sent. In case of choosing the [Individual Box Scene Object](#) option the object "[Ci] Macro: Notification" will be displayed.

Note: security in this control can be applied to the whole box or only to the configuration button, thus allowing to execute a macro, even if the user does not have permissions to configure it.

2.2.2.1.5.10 Timer

This control makes it possible to schedule the sending of binary or scene orders at a specific time (either on certain days of the week or only once).

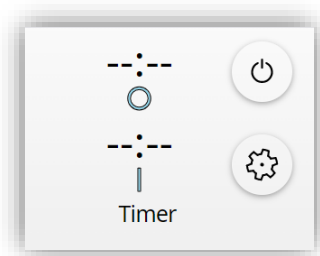

Figure 126. Timer box

The box consists of 2 buttons. The upper button enables/disables the timer (all actions will be displayed as --:-- if the timer is disabled), while the lower button opens the configuration panel.

When the timer is enabled, the configured hours will be displayed in the box. In addition, the icon ① will appear on the left side of the box if it has been configured as a **one-shot timer** or the days of the week if it has been configured as a **daily/weekly timer**.

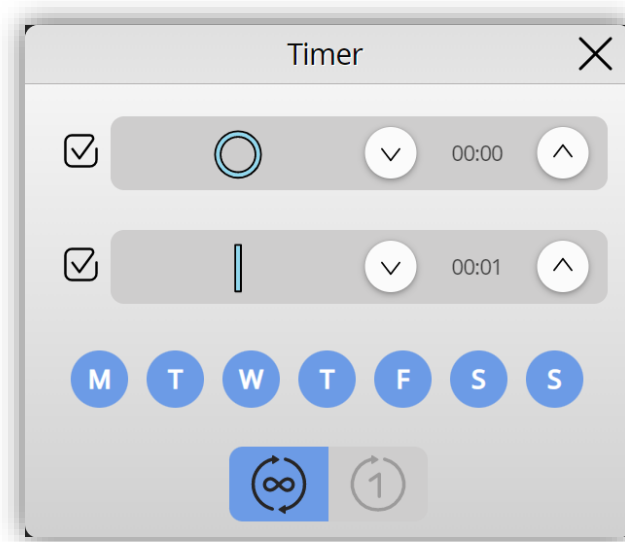

Figure 127. Timer configuration panel

Configuration panel has the following elements:

- **Actions to send:** if binary timer is parameterised, up to 2 actions can be enabled, one of them to send on and the other to send off, not allowing both actions to be disabled at the same time. If scene type timer is parameterised, the action will always be shown with the parameterised text/icon. Within each action, the time to send every action is configured.
- **Days of the week:** set the days of the week on which sending will occur.
- **Type of timer:**
 - **Daily/Week timer** (∞): the configured actions will be sent on the selected *days of the week* without ever being disabled.
 - **One-shot timer** (1): the actions will be sent when the configured time is reached. Once all actions have been sent, the timer is disabled.

Note: *days of the week will only be displayed when the timer is a daily/weekly timer.*

Closing the configuration panel causes the configured actions to be saved and the checkbox to be enabled if it is disabled.

When configuring this control in ETS, the following parameters are displayed:

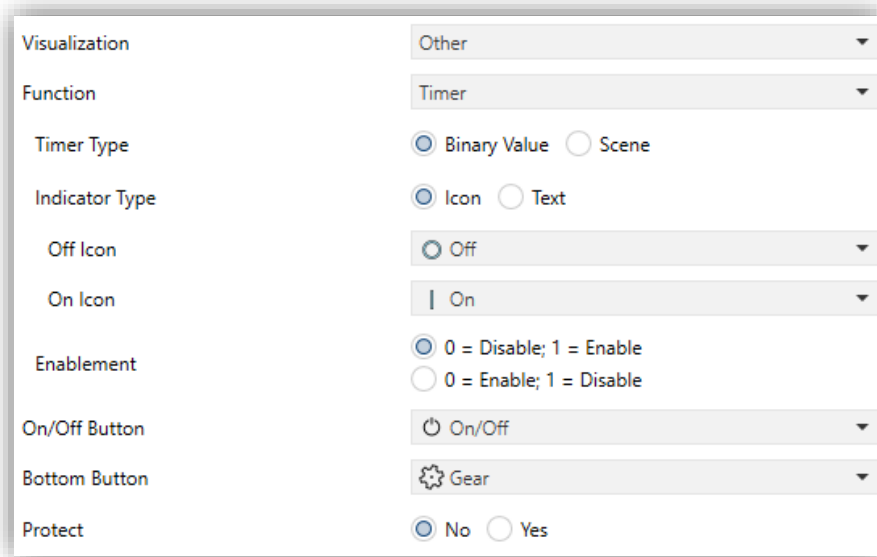

Visualization	Other
Function	Timer
Timer Type	<input checked="" type="radio"/> Binary Value <input type="radio"/> Scene
Indicator Type	<input checked="" type="radio"/> Icon <input type="radio"/> Text
Off Icon	Off
On Icon	On
Enablement	<input checked="" type="radio"/> 0 = Disable; 1 = Enable <input type="radio"/> 0 = Enable; 1 = Disable
On/Off Button	On/Off
Bottom Button	Gear
Protect	<input checked="" type="radio"/> No <input type="radio"/> Yes

Figure 128. Timer

- **Timer Type** [[Binary Value](#) / [Scene](#)]: sets the type of object to be sent when the configured time is reached. If the [Binary value](#) option is chosen, it will be sent through the object "[Ci] Timer - Switch Control". If the Scene option is chosen, the following parameters will appear:
 - **Scene Number** [[1 ... 64](#)]: scene sent when configured time is reached.
 - **Scene Object** [[General Scene Object](#) / [Individual Box Scene Object](#)]: sets the object through which the scene is sent. In case of choosing the [Individual Box Scene Object](#) option the object "[Ci] Timer – Send Scene Control" will be displayed.
- **Indicator Type** [[Icon](#) / [Text](#)]: sets whether the indicator displayed within the action is an icon or text.
- **Enablement** [[0 = Disable; 1 = Enable](#) / [0 = Enable; 1 = Disable](#)]: selects the polarity of the control object "[Ci] Timer - Enable", which will enable or disable the timer analogously as from the on-screen switch button of the box.

Note: security in this control can be applied to the whole box or only to the configuration button, thus allowing to enable the timer, even if the user does not have permissions to configure it.

2.2.2.1.5.11 Energy Monitor

This control allows access to power and energy consumption graphs.

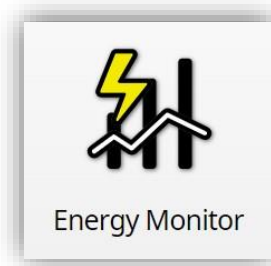

Figure 129. Energy monitor box

It is necessary to enable this functionality in the configuration tab (see section 2.1.2).

Visualization	Other
Function	Energy Monitor
Indicator Icon	 Energy Monitor
Default Energy Monitor Tab	Global Tab
Protect	<input checked="" type="radio"/> No <input type="radio"/> Yes

Figure 130. Energy Monitor

- **Indicator Icon** [[Energy Monitor](#)]: allows choosing the corresponding icon for this screen control.
- **Default Energy Monitor Tab** [[Global Tab](#) / [Individual Consumption Tab 1](#) / ... / [Individual Consumption Tab 4](#)]: allows choosing which tab is going to be displayed by default when energy monitor is opened.

2.2.2.1.5.12 IP Camera

This control allows access to IP Cameras panel.



Figure 131. IP camera box

It is necessary to enable this functionality in the configuration tab (see section 2.1.17).

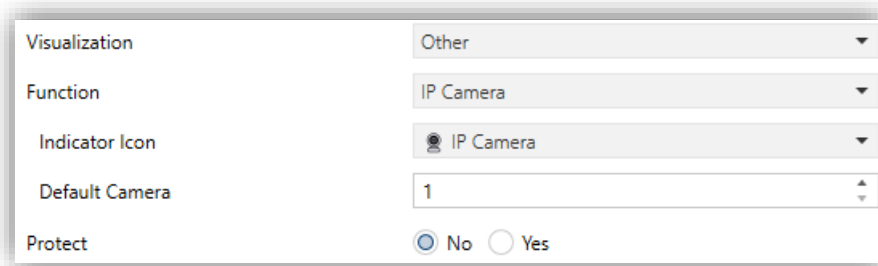

Visualization	Other
Function	IP Camera
Indicator Icon	IP Camera
Default Camera	1
Protect	<input checked="" type="radio"/> No <input type="radio"/> Yes

Figure 132. IP camera box configuration

- **Indicator Icon** [[IP Camera](#)]: allows choosing the corresponding icon for this screen control.
- **Default Camera** [[1 / ... / 10](#)]: allows choosing which camera is going to be displayed by default when panel is open through this box.

2.2.2.1.5.13 Keypad

This control allows sending numerical codes of between 1 and 14 digits through the object “[Ci] Keypad – Control”. When accessing the panel, a numeric keypad is displayed to enter the code and the buttons to delete and send the code. In case **Show Current Code** parameter is enabled, the current code will be displayed both in the box and when opening the panel.

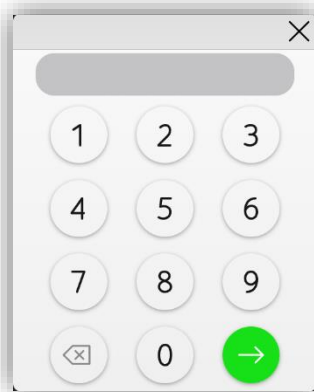
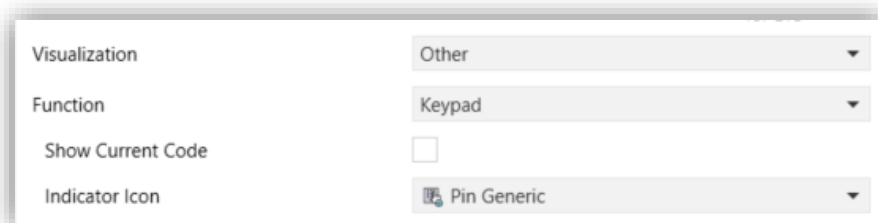

Figure 133. Numeric Keypad panel



Visualization	Other
Function	Keypad
Show Current Code	<input type="checkbox"/>
Indicator Icon	Pin Generic

Figure 134. Keypad configuration

- **Show Current Code** [[disabled](#) / [enabled](#)]: enables the object “[Ci] Keypad – Status” to display the last received code in the box.

2.3 INPUTS

Z50 / Z70 v2 / Z100 incorporates **4 analogue/digital inputs**. Each one has three possible configurations, which are explained below.

2.3.1 BINARY INPUT

Please refer to the specific user manual “**Binary Inputs**”, available in the product section, at the Zennio website (www.zennio.com).

2.3.2 TEMPERATURE PROBE

Please refer to the specific user manual “**Temperature Probe**”, available in the product section, at the Zennio website (www.zennio.com).

Note: *Z100 does not have temperature probe.*

2.3.3 MOTION DETECTOR

It is possible to connect motion detectors from Zennio to the input ports of Z50 / Z70 v2 / Z100.

Please refer to the specific user manual “**Motion Detector**”, available in the product section, at the Zennio website (www.zennio.com).

2.4 THERMOSTAT n

Z50 / Z70 v2 / Z100 implements two Zennio thermostats which can be enabled and fully customised.

Please refer to the specific manual “**Zennio Thermostat**” (available in the product section at the Zennio website, www.zennio.com) for detailed information about the functionality and the configuration of the related parameters.

ANNEX I. VIDEO INTERCOM OPERATION

INCOMING CALL

When Z50 / Z70 v2 / Z100 receives a call from a video door phone, the user interface in Figure 135 will be displayed.



Figure 135. Incoming call

During an incoming call, besides displaying the **camera image**, the following functions will be available:

- **Accept Call:** opens the ongoing call dialog (Figure 138) and notifies others synchronized screens in the same network that the call has been accepted:

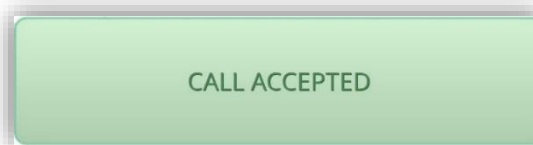

Figure 136. Message – Call accepted

- **Reject Call:** the call dialog is closed and notifies synchronized screens that the call has been rejected:

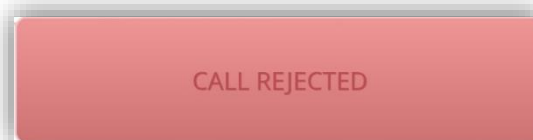

Figure 137. Message – Call rejected

The video intercom does not manifest the call rejected, so the call continues from the point of view of the visitor.

- **Open Door:** sends the door opening order via the configured method and, as configured in sections 2.1.16.1.1 and 2.1.16.1.2, a communication object. Besides all other synchronized screens will be notified that the call has been answered, although the call will remain in progress.

Note: *Configuring automatic door opening when receiving a call is possible (see section 2.1.16.1.1 and 2.1.16.1.2)*

- **Exit:** the incoming call dialog is closed but no notification is sent to the bus, so the call will continue on the rest of the synchronized screens.
- **Mute Call:** mutes the call ringtone and the rest of the synchronized screens will be notified.

ONGOING CALL

When accepting the incoming call, the interface in Figure 138 is shown and starts the voice communication with the video intercom.

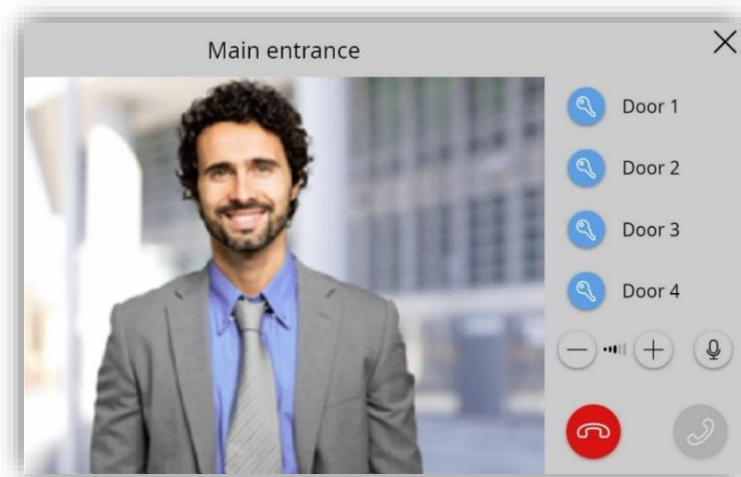

Figure 138. Ongoing call

During an ongoing call the functions available are:

- **Hang up Call:** ends the communication and closes the ongoing call dialog.
- **Open Door:** sends the door opening order via the configured method and, as configured in sections 2.1.16.1.1 and 2.1.16.1.2, a communication object.

- **Speakers Volume:** up to 5 levels of volume available plus level 0 or mute. The selected value is saved to apply in future calls.
- **Mute Microphone:** toggles between mute and enable the microphone.
- **Exit:** equivalent to reject call button.

PREVIEWING IMAGES FROM THE CAMERA

If a video intercom has been configured as a **private** and **unit with camera** (see sections 2.1.16.1.1 and 2.1.16.1.2), **the camera images** from the outdoor unit can be viewed by accessing the video intercom box (see section 2.2.2.1.5.5).

When accessing the preview of the images, the interface of Figure 139 will be shown.

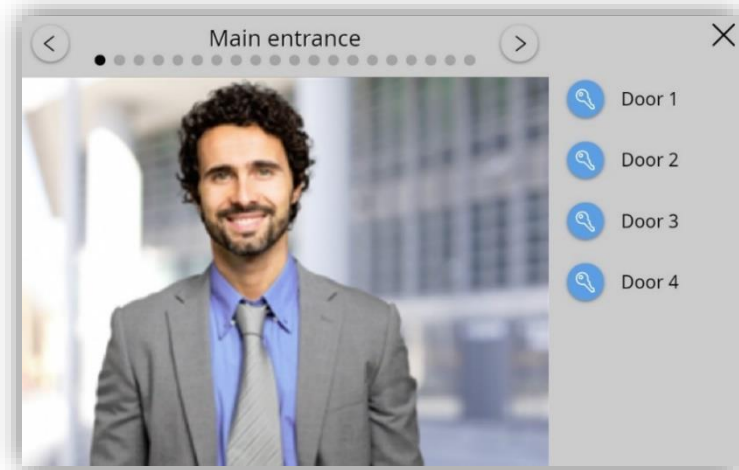

Figure 139. Preview panel

The interface will have the following elements:

- **Arrows:** will appear in case of having several external units. The arrows permit to move between the different video intercom available.
- **Camera image:** image captured by the camera from the video intercom selected through the arrows located at the top.
- **Open Door:** sends the door opening order via the configured method and, as configured in sections 2.1.16.1.1 and 2.1.16.1.2, a communication object.

Note: if outdoor unit IP is not specified in the settings, the preview of the camera image and the door opening will not be accessible until at least one incoming call has been received.

CALL LOG

A box configured as a Video Intercom (see section 2.2.2.1.5.5) has a button to access to a **Call Log**.

Every call that receives the touchscreen, or the other synchronized devices, will be registered as a new entry in the call history. The information shown in each entry is as follows:

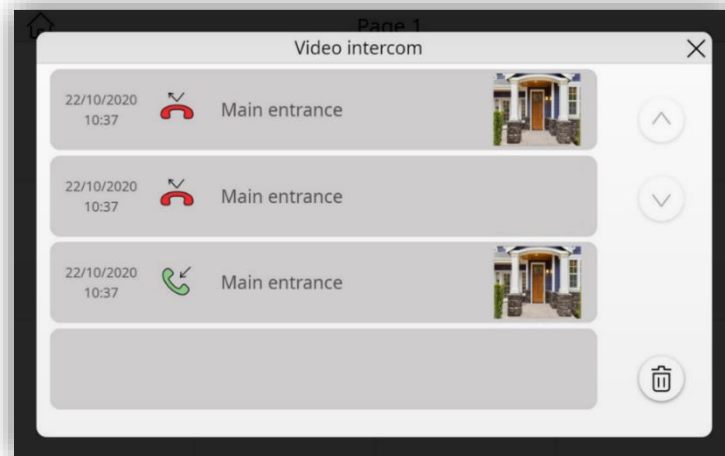

Figure 140. Video Intercom Log



- **Date and time** of the call.
- Whether the call has been **attended** , considering attended calls the accepted and the rejected calls and those where the door has been opened from the incoming call dialog, **or not attended** . Moreover, if there is a **not attended** call since the last time the call log was accessed, the indicative icon appears the video intercom box and on the page where the box is located.



Figure 141. Not attended notification (page and box)

Note: if several touchscreens are associated to the same video intercom, it is required a **synchronization** between them (see section 2.1.16) to prevent inconsistent data in the call log is recommended.

- The **video intercom name** from which the call was made.
- **First image** captured at the start of the call.

Note: *if the video intercom does not have a camera or has not been possible to save the image, the image area will be empty.*

On the right side of the window there are arrows to move through the log and a button to delete the entire log.

ANNEX II. INTERNAL CALL OPERATION

OUTCOMING CALL

To make an internal call, it is necessary to access the contact list or the numeric keypad is necessary, as setting, through the internal call box (see section 2.2.2.1.5.6).

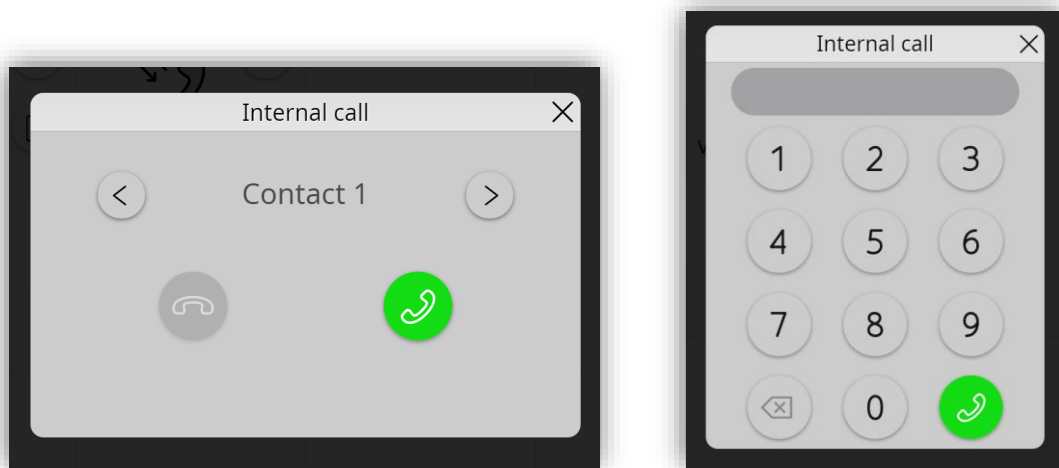

Figure 142. Contact list

The communication with the selected contact will be carried out after clicking on the **accept call** button.

When making the call the interface shown in Figure 143 is displayed, in which the following elements will be available:

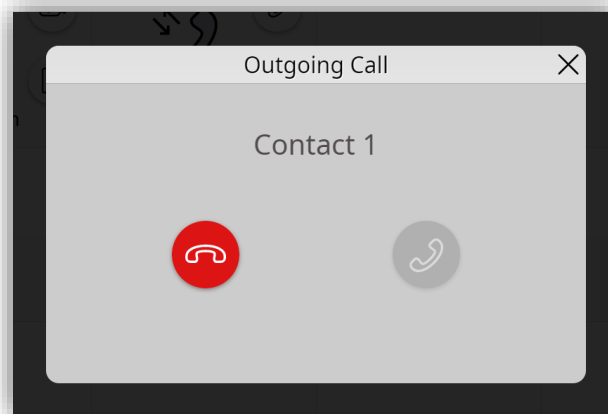

Figure 143. Outgoing call

- **Name** assigned to the contact to whom the call is directed.

- **Reject call:** rejects the call, causing the other indoor units to display a message that the call has ended:

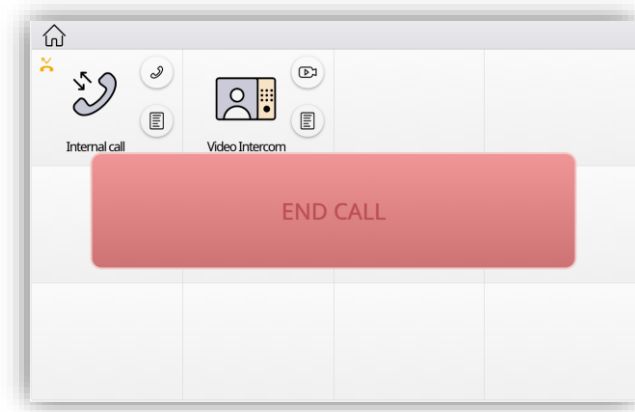

Figure 144. Message – Internal call ended.

Note:

- *Call will be cancelled if there is no answer within one minute.*
- *When the contact has an ongoing call, the outgoing call will be cancelled by displaying a message informing that the destination contact is busy:*

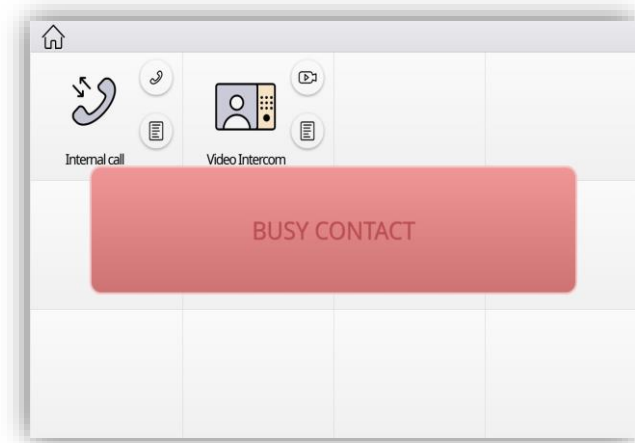

Figure 145. Message – Busy contact

- *If, when trying to make a call, the other unit is not reachable by network, the outgoing call dialog will be closed and the following message will be displayed:*

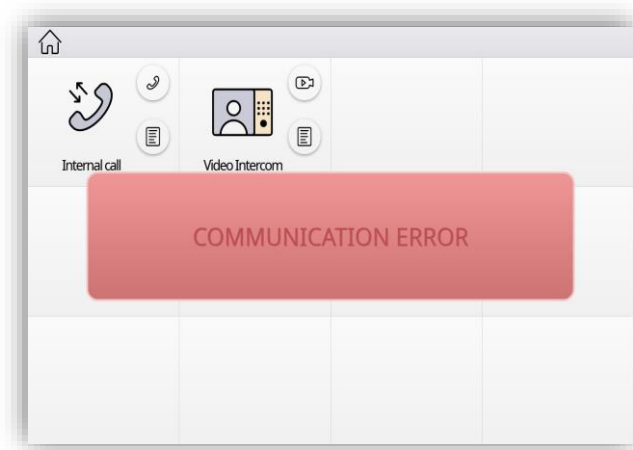

Figure 146. Message – Communication error

- The labels of the previously mentioned messages are editable (see section 2.1.16.2).

INCOMING CALL

When Z50 / Z70 v2 / Z100 is receiving a call from another screen, the following dialogue will be showed:

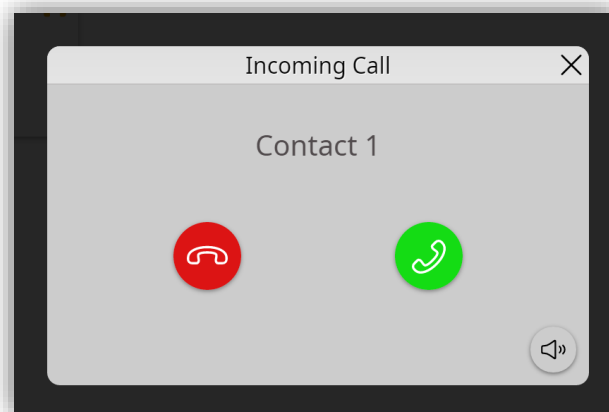

Figure 147. Incoming call

The following items are available during an incoming internal call:

- **Name** assigned to the contact from whom the call is received.
- **Reject call:** rejects the call, causing the other touchscreen to display the message informing that the call has ended.
- **Accept call:** opens ongoing call dialogue (Figure 148) initiating the audio communication.

- **Exit:** closes the dialogue without ending the call.
- **Mute:** silences the tone of the call.

ONGOING CALL

When accepting an incoming internal call, the interface in Figure 148 will be displayed.

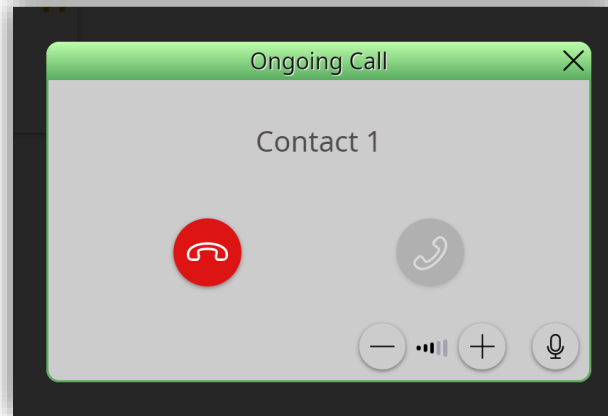

Figure 148. Ongoing call

The interface will have the following elements:

- **Hang up call:** ends the communication and closes the current call dialog. The other touchscreen shows the message informing that the call has ended.
- **Exit:** has the same effect as the reject call button.
- **Microphone Mute:** switches between mute and enable the microphone.
- **Audio volume:** changes the audio volume of the ongoing call. The selected value will be saved for future calls.



CALL LOG

If a box is configured as internal calls (see section 2.2.2.1.5.6), a button will be available to access a **call log**.

Every internal call that the touchscreen receives or makes will be recorded as a new entry in the call history. The information shown in each entry is as follows:



Figure 149. Internal call log

- **Date and time** of the call.
- Whether the call has been **attended** , considering attended calls the accepted and the rejected calls, **not attended**  or **outgoing** . Moreover, if there is a **not attended** call since the last time the call log was accessed, the indicative icon appears the internal call box and on the page where the box is located.

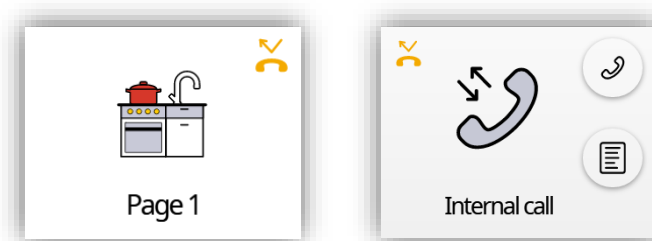

Figure 150. Not attended notification for internal calls (page and box)

- The **name of the contact**.

On the right side of the window there are arrows to move through the log and a button to delete the entire log.

ANNEX III. REMOTE CONTROL VIA IP

Z50 / Z70 v2 / Z100 feature an Ethernet interface that makes it possible to perform actions over the device by means of remote IP applications. This brings the option to control its functions analogously as if the device were actually being controlled on site.

CONFIGURATION

In order to be able to control the touchscreen from remote applications it is necessary that the integrator enables in ETS the parameter **Remote control through the Internet** inside the "Configuration" tab (see section 2.1.2).

Also, before being able to control the device remotely, it is necessary to make a previous pairing between the remote application and the touchscreen. This pairing is done in the configuration page, where the pairing box is located.

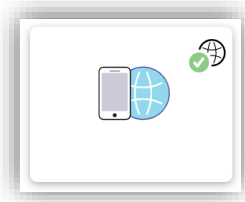

Figure 151. Device Pairing box

In the upper right corner there is a service state indicator. This indicator will be automatically updated if the state changes.

Service state	Icon
The device has not license for remote control	
No network connection	
The service is not available	
Link and service OK	
Remote control in process (remote device currently connected)	

Table 11. Service States

Note: pairing multiple touchscreens to a particular remote application is possible, as well as pairing a particular touchscreen to multiple remote applications.

PAIRING PROCEDURE

Once the touchscreen has been configured as described, pressing on the Device Pairing box will bring up a pop-up window similar to Figure 152.

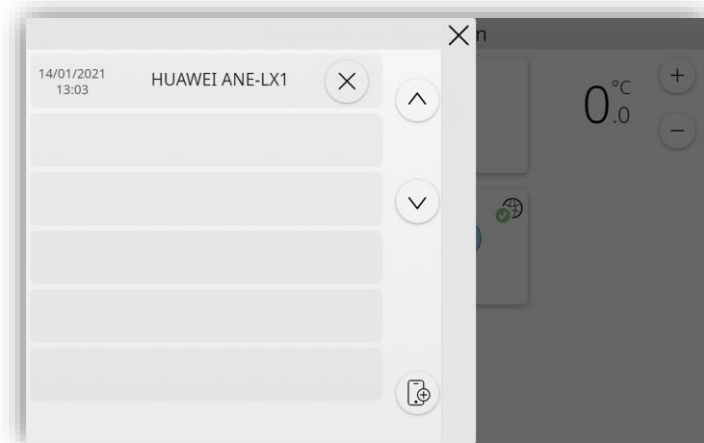

Figure 152. Pop-up to pairing device

In case there is any communication error with the server this pop-up will show an error icon, allowing only to close the tab.

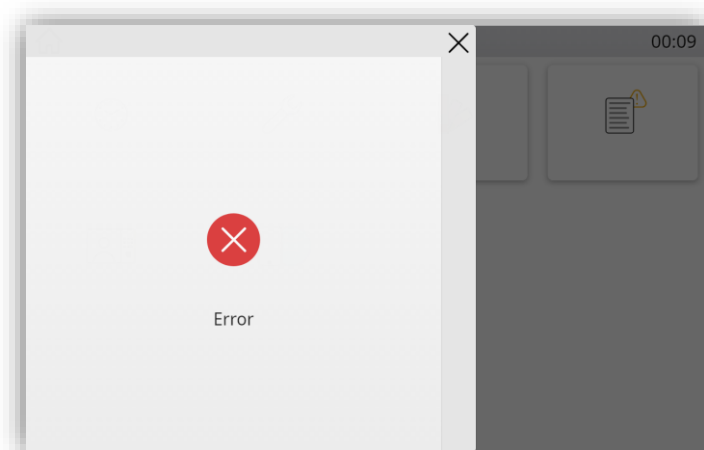



Figure 153. Communication error

This tab displayed:

- **Paired devices**, with the **time and date** of the last connection for each device and a **button to remove** the pairing with that device by long press.

- **Pairing button** : clicking on this button generates an **alphanumeric pairing code** together with a QR code. This code, which will be active for the time configured in **Pairing Code Expiration Time** (see section 2.1.2), has to be entered in the remote application to perform the pairing.

This pairing process will only need to be done once.

On the right side of the pop-up there are arrows to scroll through the list of paired devices.

PUSH NOTIFICATIONS

Z50 / Z70 v2 / Z100 incorporates the “push” notification function, which consists in notifying the mobile devices (no matter if the remote control application has been started or not) about alarm events:

- **Alarm activation:** a box that has been assigned the Alarm function has either received the alarm trigger value from the KNX bus, or exceeded the cyclical monitoring period.
- **Alarm confirmation:** a box with an active alarm has been acknowledged by the user.
- **Alarm deactivation:** a box that has already been acknowledged by the user has also received the no-alarm trigger value. Therefore, the alarm has been deactivated and acknowledged.

The above notifications are shown on the mobile device (unless “push” notifications are disabled by the operating system of the device, depending on the user settings) according to the label assigned to the involved alarm box.

Note: *Zennio Avance y Tecnología S.L. does not accept any responsibility for losses of “push” messages due to network, hardware or software failures of any kind.*

REMOTE APPLICATIONS

For instructions on configuring and using the available remote applications, please refer to the “Zennio Remote” specific document, available at the Zennio home site: www.zennio.com.

ANNEX IV. GRAPHS

Z50 / Z70 v2 / Z100 can display graphs with a history of the values received through the indicator objects of the different boxes. The boxes that have this functionality enabled will have a button on the top left to access the graph.

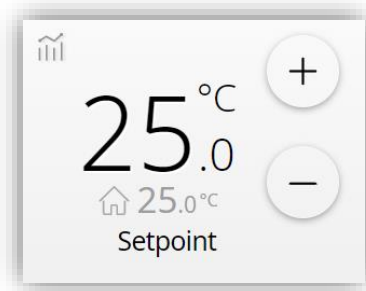

Figure 154. Control with enabled graph

The graphs displayed may have different types of representation depending on the type of data to be displayed:

● Switch:



● Curve:

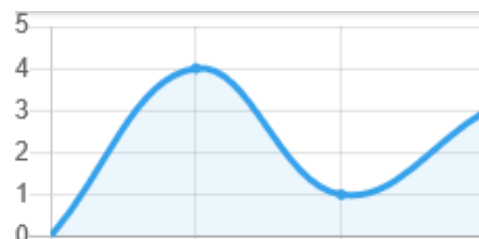

● Straight:

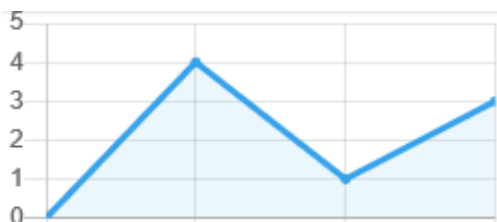

● Step:

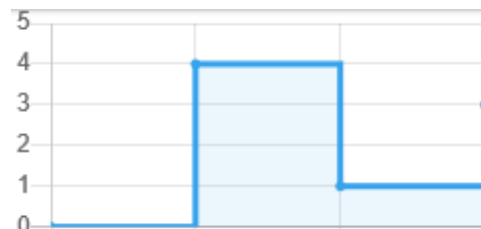

Depending on the type of control parameterised, it will be possible to enable or disable the option of displaying its graph. The following table shows the controls that allow graphs to be displayed and the type of representation available for each of them:

Type of control	Function	Type of representation available
Indicator	Binary	Switching graph
	Integer	Line graph [curve/straight/step]
	Percentage	Line graph [curve/straight/step]
	Float	Line graph [curve/straight/step]
	Temperature	Line graph [curve/straight/step]
1-Button Control	Switch	Switching graph
	Two Objects (Short Press/Long Press)	Switching graph
2-Button Control	Switch	Switching graph
	Switch + Indicator (counter)	Line graph [curve/straight/step]
	Switch + Indicator (scaling)	Line graph [curve/straight/step]
	Switch + Indicator (float)	Line graph [curve/straight/step]
	Switch + Indicator (temperature)	Line graph [curve/straight/step]
	Two Objects (Short Press/Long Press)	Switching graph
	Counter	Line graph [curve/straight/step]
	Scaling	Line graph [curve/straight/step]
	Float	Line graph [curve/straight/step]
	Shutter	Line graph [step]
Dimmer	Line graph [step]	
Climate Control	Temperature Setpoint	Line graph [Setpoint: step; Real: curve]
	Fan (Scaling)	Line graph [step]

Table 12. Controls allowing graphs

GRAPH PANEL

The graph panel has the following elements:

- **Graph:** this will be the main element where the recorded data is displayed. The x-axis will correspond to the period shown and the y-axis will be adjusted depending on the maximum and minimum value shown in that period. In addition, the information of the period being displayed will be shown at the top right.
- **Navigation buttons:** at the bottom, the buttons to navigate through the graph will be displayed to select the period to be shown. The zoom level is changed by enabling/disabling each checkbox. A simple example of navigation is shown below:

To access the graph of 29 April 2022, it will be necessary to uncheck the time checkbox and set 29 April 2022 by using the arrows.



Figure 155. Graph panel

For more precise information, a tooltip will be displayed when clicking on any of the recorded data. The exact time of the received data and the recorded value are indicated inside.

ZOOM LEVELS

Within the panel it is possible to access different zoom levels by enabling and disabling the checkboxes in the navigation area:

- **Day and hour levels:** these two levels show the data recorded with a zoom level of one day or one hour.
- **Month and year levels:** these two zoom levels show the averages, maximums and minimums of the data recorded each day or each month.
- **Global level:** when all the checkboxes are unchecked, a global view is displayed showing the monthly averages of the last 5 years recorded.

Note: in the case of switching or step type graphs only the day and hour levels will be available.

DATA MANAGEMENT

The recorded **data is stored** in memory every **5 minutes** (only if the device has a valid time). If the number of data received in that period exceeds 4, the device performs a filtering by selecting the 4 values that will best define the graph.

There are some cases where the device can make a partial **deletion** of the recorded data:

- When a change of date and time is made and the device has data stored from later dates than the one established, these will be deleted to avoid having duplicate data at the same time. Data before that date will remain stored.
- When the memory is full, the oldest 30 days that have been recorded will be deleted.

The recorded data can be deleted or downloaded from the web server. For further information, please refer to the “**Webserver Tools**” manual (available in the product section in Zennio web portal, www.zennio.com).

ANNEX V. ENERGY MONITOR CONFIGURATION

In order to make use of the energy monitor functionality, it is necessary to have a consumption meter to send the measurements, for example KES Plus. The power and energy objects of the consumption meter will be associated with the corresponding power and energy objects of the energy monitor.

Notes:

- The energy objects must be linked to a total register, so that the received energy value is always increasing and does not reset.
- It is recommended to have the **Automatic Read Requests** parameter enabled to ensure the correct value at the end of each period.

INSTALLATION

This section defines the points of the installation where the measurements must be taken in order to have a correct operation of the global tab of the energy monitor. Figure 156 shows the diagram of an installation with solar panels and battery:

- Point 1 measures the energy imported and exported.
- Point 2 measures the energy produced at the inverter output.
- Point 3 measures the energy consumed in the house.

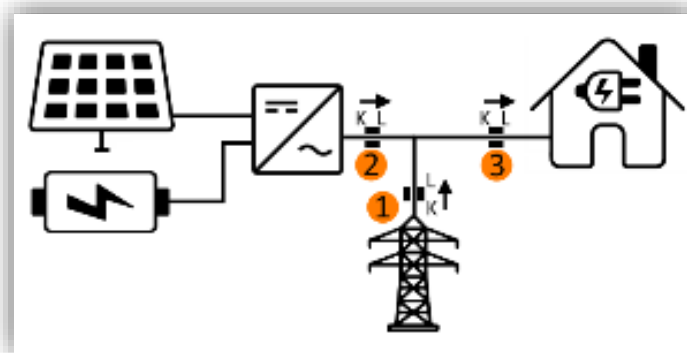

Figure 156. Installation diagram with solar panels and battery

Depending on the type of installation, there may be 1, 2 or 3 measurement points:

- **Installation without solar panels or battery:** only point 1 shown in the diagram in Figure 156.
- **Installation with solar panels:** in this case, can be 2 or 3 measurement points. The ideal case would be to have all 3 points in the diagram, but in some cases point 3 is not accessible and the monitor can be configured with only points 1 and 2.

ANNEX VI. COMMUNICATION OBJECTS

- “**Functional range**” shows the values that, with independence of any other values permitted by the bus according to the object size, may be of any use or have a particular meaning because of the specifications or restrictions from both the KNX standard or the application program itself.

Note: The number of instances of every functional block can vary between devices, as it is explained in the table 1.

Number	Size	I/O	Flags	Data type (DPT)	Functional Range	Name	Function
1	3 Bytes	I	C - W T U	DPT_TimeOfDay	00:00:00 - 23:59:59	[General] Time of Day	Time of Day External Reference
2	3 Bytes	I	C - W T U	DPT_Date	01/01/1990 - 31/12/2089	[General] Date	Date External Reference
3	1 Byte	O	C - - T -	DPT_SceneControl	0-63; 128-191	[General] Scenes: Send	0-63/128-191 (Run/Save Scene 1-64)
4	1 Byte	I	C - W - -	DPT_SceneNumber	0 - 63	[General] Scenes: Receive	0-63 (Run Scene 1-64)
5	1 Bit	I	C - W - -	DPT_State	0/1	[General] Activity	0 = Inactivity; 1 = Activity
6	1 Byte	I	C - W - -	Locale Enumeration	0 - 5	[General] Localisation - Select	0 = Main; 1 = Conf. 2; ...; 4 = Conf. 5
7	4 Bytes	I	C - W - -	1.xxx	0/1	[General] Localisation - Select	Locale Selection Through ISO 639-1/ISO 3166-1 Four Letters Code
8	2 Bytes	I	C - W - -	DPT_LanguageCodeAlpha2_ASCII		[General] Translations - Select	Language Selection Through ISO 639-1 Two Letters Code
9	1 Bit	I	C - W T U	DPT_Enable	0/1	[General] Touch Locking	0 = Unlock; 1 = Lock
	1 Bit	I	C - W T U	DPT_Enable	0/1	[General] Touch Locking	0 = Lock; 1 = Unlock
10	2 Bytes	I	C - W T U	DPT_Value_Temp	-273.00° - 670433.28°	[General] External Temperature	Temperature to show in the display
11	1 Bit	I	C - W T -	DPT_Ack	0/1	[General] Cleaning Function	0 = Nothing; 1 = Clean Now
12	1 Bit	O	C R - T -	DPT_Switch	0/1	[General] Welcome Back Object	Switch Object Sent on Wake Up
13, 14, 15, 16, 17	1 Bit	I	C - W - -	DPT_Switch	0/1	[General] Welcome Back Object - Additional Condition	Additional Condition Object x
18	1 Bit	I	C - W T U	DPT_Switch	0/1	[General] Temperature Scale	0 = °C; 1 = °F
19, 25, 31, 37, 43, 49	1 Bit	I	C - W - -	DPT_Switch	0/1	[General][Pop-Up x] 1 Bit	0 = Hide Pop-Up; 1 = Show Pop-Up
	1 Bit	I	C - W - -	DPT_Switch	0/1	[General][Pop-Up x] 1 Bit	0 = Show Pop-Up; 1 = Hide Pop-Up
20, 26, 32, 38, 44, 50	1 Byte	I	C - W - -	DPT_Value_1_Ucount	0 - 255	[General][Pop-Up x] 1 Byte	Hide/Show Pop-Up
21, 22, 23, 24, 27, 28, 29, 30, 33, 34, 35, 36,	14 Bytes	I	C - W - -	DPT_String_UTF-8		[General][Pop-Up x] Line x	Text to Show on the Display at Line x

39, 40, 41, 42, 45, 46, 47, 48, 51, 52, 53, 54							
55	1 Byte	I	C - W T -	1.xxx	0/1	[Profile] Theme	0 = Light; 1 = Dark
56	1 Byte	I	C - W T -	DPT_Scaling	0% - 100%	[Profile] Volume	0% ... 100%
57	1 Bit	I	C - W - -	DPT_Ack	0/1	[General] Doorbell	1 = Play Doorbell
	1 Bit	I	C - W - -	DPT_Ack	0/1	[General] Doorbell	0 = Play Doorbell
58	1 Byte	I	C - W T -	DPT_Value_1_Ucount	0 - 255	[Profile] Doorbell Tone	0 = Tone 1; 1 = Tone 2; ... ; 6 = Tone 7
59	1 Byte	I	C - W T -	DPT_Scaling	0% - 100%	[Profile] Doorbell Volume	0% ... 100%
60	1 Byte	I/O	C R W T -	DPT_Scaling	0% - 100%	[VoIP] Ringtone Volume	0% ... 100%
61	1 Byte	I/O	C R W T -	DPT_Value_1_Ucount	0 - 255	[VoIP] Video Intercom Ringtone	0 = Tone 1; 1 = Tone 2; ... ; 6 = Tone 7
62	1 Byte	I/O	C R W T -	DPT_Value_1_Ucount	0 - 255	[VoIP] Internal Call Ringtone	0 = Tone 1; 1 = Tone 2; ... ; 6 = Tone 7
	1 Bit	I	C - W - -	DPT_Ack	0/1	[VoIP] Play Video Intercom Ringtone	1 = Play Ringtone
63	1 Bit	I	C - W - -	DPT_Ack	0/1	[VoIP] Play Video Intercom Ringtone	0 = Play Ringtone
	1 Bit	I	C - W - -	DPT_Ack	0/1	[VoIP] Play Internal Call Ringtone	1 = Play Ringtone
64	1 Bit	I/O	C R W T -	DPT_Enable	0/1	[VoIP] "Do Not Disturb" Mode	0 = Normal; 1 = Do Not Disturb
65	1 Bit	O	C - - T -	DPT_Boot	0/1	[VoIP] Active Call	0 = Call Finished; 1 = Active Call
66	1 Bit	O	C - - T -	DPT_Ack	0/1	[VI x] Switch x	1 = Open
67, 68, 69, 70, 76, 77, 78, 79, 85, 86, 87, 88, 94, 95, 96, 97, 103, 104, 105, 106, 112, 113, 114, 115, 121, 122, 123, 124, 130, 131, 132, 133, 139, 140, 141, 142, 148, 149, 150, 151, 157, 158, 159, 160, 166, 167, 168, 169, 175, 176, 177, 178, 184, 185, 186, 187, 193, 194, 195, 196, 202, 203, 204, 205, 211, 212, 213, 214, 220, 221, 222, 223, 229, 230, 231, 232, 238, 239, 240, 241	1 Bit	O	C - - T -	DPT_Ack	0/1	[VI x] Switch x	0 = Open
71, 72, 73, 74, 80, 81, 82, 83, 89, 90, 91, 92, 98, 99, 100, 101, 107, 108, 109, 110, 116, 117, 118, 119, 125, 126, 127, 128, 134,	1 Bit	I	C - W - -	DPT_Ack	0/1	[VI x] Trigger Switch x	1 = Open
	1 Bit	I	C - W - -	DPT_Ack	0/1	[VI x] Trigger Switch x	0 = Open

135, 136, 137, 143, 144, 145, 146, 152, 153, 154, 155, 161, 162, 163, 164, 170, 171, 172, 173, 179, 180, 181, 182, 188, 189, 190, 191, 197, 198, 199, 200, 206, 207, 208, 209, 215, 216, 217, 218, 224, 225, 226, 227, 233, 234, 235, 236, 242, 243, 244, 245							
75, 84, 93, 102, 111, 120, 129, 138, 147, 156, 165, 174, 183, 192, 201, 210, 219, 228, 237, 246	1 Bit	I/O	C R W T -	DPT_Enable	0/1	[VI x] Enable Automatic Door Opening	0 = Disable; 1 = Enable
247, 248, 249, 250	1 Bit	O	C - - T -	DPT_Ack	0/1	[VI G][x] Switch x	1 = Open
	1 Bit	O	C - - T -	DPT_Ack	0/1	[VI G][x] Switch x	0 = Open
251, 252, 253, 254	1 Bit	I	C - W - -	DPT_Ack	0/1	[VI G][x] Trigger Switch x	1 = Open
	1 Bit	I	C - W - -	DPT_Ack	0/1	[VI G][x] Trigger Switch x	0 = Open
255	1 Bit	I/O	C R W T -	DPT_Enable	0/1	[VI G][x] Enable Automatic Door Opening	0 = Disable; 1 = Enable
256	4 Bytes	I	C - W T U	DPT_ActiveEnergy	0 - 2147483647	[EM] Consumed Energy	W·h
	4 Bytes	I	C - W T U	DPT_ActiveEnergy_kWh	0 - 2147483647	[EM] Consumed Energy	kW·h
257	4 Bytes	I	C - W T U	DPT_ActiveEnergy	0 - 2147483647	[EM] Imported Energy	W·h
	4 Bytes	I	C - W T U	DPT_ActiveEnergy_kWh	0 - 2147483647	[EM] Imported Energy	kW·h
258	4 Bytes	I	C - W T U	DPT_ActiveEnergy	0 - 2147483647	[EM] Exported Energy	W·h
	4 Bytes	I	C - W T U	DPT_ActiveEnergy_kWh	0 - 2147483647	[EM] Exported Energy	kW·h
259	4 Bytes	I	C - W T U	DPT_ActiveEnergy	0 - 2147483647	[EM] Produced Energy	W·h
	4 Bytes	I	C - W T U	DPT_ActiveEnergy_kWh	0 - 2147483647	[EM] Produced Energy	kW·h
260	4 Bytes	I	C - W - -	DPT_Value_Power		[EM] Consumed Power	W
	2 Bytes	I	C - W - -	DPT_Power	-671088.64 - 670433.28 kW	[EM] Consumed Power	kW
261	4 Bytes	I	C - W - -	DPT_Value_Power		[EM] Imported/Exported Power	W (> 0 = Imported; < 0 = Exported)

	2 Bytes	I	C - W - -	DPT_Power	-671088.64 - 670433.28 kW	[EM] Imported/Exported Power	kW (> 0 = Imported; < 0 = Exported)
	4 Bytes	I	C - W - -	DPT_Value_Power		[EM] Imported Power	W
	2 Bytes	I	C - W - -	DPT_Power	-671088.64 - 670433.28 kW	[EM] Imported Power	kW
262	4 Bytes	I	C - W - -	DPT_Value_Power		[EM] Exported Power	W
	2 Bytes	I	C - W - -	DPT_Power	-671088.64 - 670433.28 kW	[EM] Exported Power	kW
263	4 Bytes	I	C - W - -	DPT_Value_Power		[EM] Produced Power	W
	2 Bytes	I	C - W - -	DPT_Power	-671088.64 - 670433.28 kW	[EM] Produced Power	kW
312, 313, 314, 315, 316, 317, 318, 319, 320, 321	1 Bit	I/O	C R W T U	DPT_Switch	0/1	[Camera x] Switch - Control: "x"	1-Bit Generic Control
	1 Byte	O	C - - T -	DPT_SceneNumber	0 - 63	[Camera x] Scene - Send Scene Control	0-63 (Run Scene 1-64)
	1 Bit	I/O	C R W T U	DPT_Switch	0/1	[Camera x] Switch - Control: "x/x"	1-Bit Generic Control
322, 323, 324, 325, 326, 327, 328, 329, 330, 331, 332, 333, 334, 335, 336, 337, 338, 339, 340, 341, 342, 343, 344, 345, 346, 347, 348, 349, 350, 351	1 Bit	I/O	C R W T U	DPT_Enable	0/1	[Sx] Scheduler - Enable	0 = Disable; 1 = Enable
352, 353, 354, 355, 356, 357, 358, 359	1 Bit	I	C - W - -	DPT_Switch	0/1	[Config.][Bx] Show/Hide Box	0 = Hide Box; 1 = Show Box
360, 361, 362, 363, 364, 365, 366, 367, 368, 369, 370, 371, 372, 373, 374, 375, 376, 377, 378, 379, 380, 381, 382, 383, 384, 385, 386, 387, 388, 389, 390, 391, 392, 393, 394, 395, 396, 397, 398, 399, 400, 401, 402, 403, 404, 405, 406, 407, 408, 409, 410, 411, 412, 413, 414, 415, 416, 417, 418, 419, 420, 421, 422, 423, 424, 425, 426, 427,	1 Bit	I	C - W - -	DPT_Switch	0/1	[Px][Bx] Show/Hide Box	0 = Hide Box; 1 = Show Box

428, 429, 430, 431, 432, 433, 434, 435, 436, 437, 438, 439, 440, 441, 442, 443, 444, 445, 446, 447, 448, 449, 450, 451, 452, 453, 454, 455, 456, 457, 458, 459, 460, 461, 462, 463, 464, 465, 466, 467, 468, 469, 470, 471, 472, 473, 474, 475, 476, 477, 478, 479, 480, 481, 482, 483, 484, 485, 486, 487, 488, 489, 490, 491, 492, 493, 494, 495, 496, 497, 498, 499, 500, 501, 502, 503, 504, 505, 506, 507, 508, 509, 510, 511, 512, 513, 514, 515, 516, 517, 518, 519, 520, 521, 522, 523, 524, 525, 526, 527, 528, 529, 530, 531, 532, 533, 534, 535, 536, 537, 538, 539, 540, 541, 542, 543, 544, 545, 546, 547, 548, 549, 550, 551, 552, 553, 554, 555, 556, 557, 558, 559, 560, 561, 562, 563, 564, 565, 566, 567, 568, 569, 570, 571, 572, 573, 574, 575, 576, 577, 578, 579, 580, 581, 582, 583, 584, 585, 586, 587, 588, 589, 590, 591, 592, 593, 594, 595, 596, 597, 598, 599							
	1 Bit	I	C - W T U	DPT_Switch	0/1	[Cx] Switch - Status	1-Bit Indicator
600, 606, 612, 618, 624, 630, 636, 642, 648, 654, 660, 666, 672, 678, 684	1 Byte	I	C - W T U	DPT_Value_1_Ucount	0 - 255	[Cx] Enumeration - Status	0 ... 255
	1 Byte	I	C - W T U	DPT_Value_1_Count	-128 - 127	[Cx] Integer - 1-Byte Signed Status	-128 ... 127
	2 Bytes	I	C - W T U	DPT_Value_2_Count	-32768 - 32767	[Cx] Integer - 2-Byte Signed Status	-32768 ... 32767

1 Byte	I	C - W T U	DPT_Value_1_Ucount	0 - 255	[Cx] Integer - 1-Byte Unsigned Status	0 ... 255
2 Bytes	I	C - W T U	DPT_Value_2_Ucount	0 - 65535	[Cx] Integer - 2-Byte Unsigned Status	0 ... 65535
1 Byte	I	C - W T U	DPT_Scaling	0% - 100%	[Cx] Percentage - Status	0% ... 100%
2 Bytes	I	C - W T U	9.xxx	-671088.64 - 670433.28	[Cx] Float - 2-Byte Status	-671088.64 ... 670433.28
2 Bytes	I	C - W T U	DPT_Value_Temp	-273.00° - 670433.28°	[Cx] Temperature - Status	-99°C ... 199°C
1 Byte	I	C - W T U	DPT_Value_1_Ucount	0 - 255	[Cx] Cost - 1-Byte Unsigned Int Status	0 ... 255
1 Byte	I	C - W T U	DPT_Value_1_Count	-128 - 127	[Cx] Cost - 1-Byte Signed Int Status	-128 ... 127
2 Bytes	I	C - W T U	DPT_Value_2_Ucount	0 - 65535	[Cx] Cost - 2-Byte Unsigned Int Status	0 ... 65535
2 Bytes	I	C - W T U	DPT_Value_2_Count	-32768 - 32767	[Cx] Cost - 2-Byte Signed Int Status	-32768 ... 32767
2 Bytes	I	C - W T U	9.xxx	-671088.64 - 670433.28	[Cx] Cost - 2-Byte Float Status	-671088.64 ... 670433.28
1 Bit	I	C - W T U	DPT_Switch	0/1	[Cx] Two Objects - Switch Status	1-Bit Indicator
1 Byte	I	C - W T U	DPT_Room_State	0 - 2	[Cx] Room State - Status	0 = Normal; 1 = Make Up Room; 2 = Do Not Disturb
1 Byte	I	C - W T U	DPT_Scaling	0% - 100%	[Cx] Shutter - Percentage Status	0% = Top; 100% = Bottom
1 Byte	I	C - W T U	DPT_Scaling	0% - 100%	[Cx] Light - Percentage Status	0% = Off; 100% = On
2 Bytes	I	C - W T U	DPT_Value_Temp	-273.00° - 670433.28°	[Cx] Setpoint - Temperature Status	-99°C ... 199°C
1 Bit	I	C - W T U	DPT_Heat_Cool	0/1	[Cx] Mode - Status	0 = Cool; 1 = Heat
1 Byte	I	C - W T U	DPT_HVACContrMode	0=Auto 1=Heat 3=Cool 9=Fan 14=Dry	[Cx] Mode - Status	Auto, Heat, Cool, Fan and Dry
1 Byte	I	C - W T U	DPT_Scaling	0% - 100%	[Cx] Fan - Percentage Status	0 - 100%
1 Byte	I	C - W T U	DPT_Fan_Stage	0 - 255	[Cx] Fan - Enumeration Status	Enumerated Value
1 Byte	I	C - W T U	DPT_HVACMode	1=Comfort 2=Standby 3=Economy 4=Building Protection	[Cx] Special Mode - Status	Auto, Comfort, Standby, Economy and Building Protection
1 Byte	I/O	C R W T U	DPT_Scaling	0% - 100%	[Cx] RGB - Red Channel	0% ... 100%
3 Bytes	I/O	C R W T U	DPT_Colour_RGB	[0 - 255] * 3	[Cx] RGB - RGB Color	Red, Green and Blue Components

	6 Bytes	I/O	C R W T U	DPT_Colour_RGBW	[0 - 1] * 4 - [0 - 255] * 4	[Cx] RGBW - RGBW Color	Red, Green, Blue and White Components
	1 Bit	I	C - W - U	DPT_Alarm	0/1	[Cx] Alarm - Trigger	Trigger: 0
	1 Bit	I	C - W - U	DPT_Alarm	0/1	[Cx] Alarm - Trigger	Trigger: 1
	14 Bytes	I	C - W T U	DPT_String_UTF-8		[Cx] Text - Status	Text String
	4 Bytes	I	C - W T U	DPT_Value_4_Count	-2147483648 - 2147483647	[Cx] Integer - 4-Byte Signed Status	-2147483648 ... 2147483647
	4 Bytes	I	C - W T U	DPT_Value_4_Ucount	0 - 4294967295	[Cx] Integer - 4-Byte Unsigned Status	0 ... 4294967295
	4 Bytes	I	C - W T U	14.xxx		[Cx] Float - 4-Byte Status	-3.403E+38 ... 3.403E+38
	1 Bit	I	C - W - -	DPT_Start	0/1	[Cx] Macro - Trigger	0 = Stop; 1 = Start
	1 Bit	I	C - W - -	DPT_Start	0/1	[Cx] Macro - Trigger	0 = Start; 1 = Stop
	1 Bit	I	C - W - -	DPT_Enable	0/1	[Cx] Timer - Enable	0 = Enable; 1 = Disable
	1 Bit	I	C - W - -	DPT_Enable	0/1	[Cx] Timer - Enable	0 = Disable; 1 = Enable
	1 Byte	I/O	C R W T U	DPT_Scaling	0% - 100%	[Cx] RGBW - Red Channel	0% ... 100%
	3 Bytes	I/O	C R W T U	DPT_Colour_RGB	[0 - 255] * 3	[Cx] RGBW - RGB Color	Red, Green and Blue Components
	1 Bit	I	C - W T U	DPT_Switch	0/1	[Cx] Hold & Release - Switch Status	1-Bit Indicator
	1 Byte	I	C - W T U	DPT_Value_1_Count	-128 - 127	[Cx] Switch - x-Byte Signed Int Status	-128 ... 127
	1 Byte	I	C - W T U	DPT_Value_1_Ucount	0 - 255	[Cx] Switch - x-Byte Unsigned Int Status	0 ... 255
	2 Bytes	I	C - W T U	DPT_Value_2_Count	-32768 - 32767	[Cx] Switch - x-Byte Signed Int Status	-32768 ... 32767
	2 Bytes	I	C - W T U	DPT_Value_2_Ucount	0 - 65535	[Cx] Switch - x-Byte Unsigned Int Status	0 ... 65535
	1 Byte	I	C - W T U	DPT_Scaling	0% - 100%	[Cx] Switch - Percentage Status	0% ... 100%
	2 Bytes	I	C - W T U	9.xxx	-671088.64 - 670433.28	[Cx] Switch - x-Byte Float Status	-671088.64 ... 670433.28
	2 Bytes	I	C - W T U	DPT_Value_Temp	-273.00° - 670433.28°	[Cx] Switch - Temperature Status	-99°C ... 199°C
	14 Bytes	I	C - W T U	DPT_String_UTF-8		[Cx] Keypad - Status	Text String
	601, 607, 613, 619, 625, 631, 637, 643, 649, 655, 661, 667, 673, 679, 685	1 Bit	O	C R - T -	DPT_Switch	0/1	[Cx] Switch - Control: "x"
1 Bit		O	C R - T -	DPT_Switch	0/1	[Cx] Switch - Control: "x/x"	1-Bit Generic Control
1 Bit		O	C R - T -	DPT_Switch	0/1	[Cx] Two Objects - Short Press Control: "0"	1-Bit Generic Control
1 Bit		O	C R - T -	DPT_Switch	0/1	[Cx] Two Objects - Short Press Control: "1"	1-Bit Generic Control

1 Bit	O	CR-T-	DPT_Switch	0/1	[Cx] Two Objects - Short Press Control: "0/1"	1-Bit Generic Control
1 Byte	O	CR-T-	DPT_Value_1_Ucount	0 - 255	[Cx] Two Objects - Short Press Control: 1-Byte	Send Selected 1-Byte Value on Short Press
1 Bit	O	CR-T-	DPT_Switch	0/1	[Cx] Hold & Release - Switch Control	1-Bit Generic Control
1 Byte	O	C--T-	DPT_SceneNumber	0 - 63	[Cx] Scene - Send Scene Control	0-63 (Run Scene 1-64)
1 Byte	O	C--T-	DPT_SceneControl	0-63; 128-191	[Cx] Scene - Send Scene Control	0-63/128-191 (Run/Save Scene 1-64)
1 Byte	O	CR-T-	DPT_Value_1_Count	-128 - 127	[Cx] Integer - 1-Byte Signed Control	-128 ... 127
1 Byte	O	CR-T-	DPT_Value_1_Ucount	0 - 255	[Cx] Integer - 1-Byte Unsigned Control	0 ... 255
2 Bytes	O	CR-T-	DPT_Value_2_Count	-32768 - 32767	[Cx] Integer - 2-Byte Signed Control	-32768 ... 32767
2 Bytes	O	CR-T-	DPT_Value_2_Ucount	0 - 65535	[Cx] Integer - 2-Byte Unsigned Control	0 ... 65535
1 Byte	O	CR-T-	DPT_Scaling	0% - 100%	[Cx] Percentage - Control	0% ... 100%
2 Bytes	O	CR-T-	9.xxx	-671088.64 - 670433.28	[Cx] Float - 2-Byte Control	-671088.64 ... 670433.28
1 Byte	O	CR-T-	DPT_Room_State	0 - 2	[Cx] Room State - Control	0 = Normal; 1 = Make Up Room; 2 = Do Not Disturb
1 Byte	O	CR-T-	DPT_Value_1_Ucount	0 - 255	[Cx] Enumeration - Control	0 ... 255
1 Bit	O	CR-T-	DPT_Switch	0/1	[Cx] Switch - Control	1-Bit Generic Control
1 Bit	O	CR-T-	DPT_Switch	0/1	[Cx] Two Objects - Short Press Control	1-Bit Generic Control
1 Byte	O	C--T-	DPT_SceneNumber	0 - 63	[Cx] Two Scenes - Top Scene Send Control	0-63 (Run Scene 1-64)
1 Byte	O	C--T-	DPT_SceneControl	0-63; 128-191	[Cx] Two Scenes - Top Scene Send Control	0-63/128-191 (Run/Save Scene 1-64)
1 Bit	O	CR-T-	DPT_Step	0/1	[Cx] Shutter - Stop/Step Control	0 = Stop/Step Up; 1 = Stop/Step Down
1 Bit	O	CR-T-	DPT_Trigger	0/1	[Cx] Shutter - Stop Control	0/1 = Stop
1 Bit	O	CR-T-	DPT_Switch	0/1	[Cx] Light - Switch Control	0 = Off; 1 = On
2 Bytes	O	CR-T-	DPT_Value_Temp	-273.00° - 670433.28°	[Cx] Setpoint - Temperature Control	-99°C ... 199°C
1 Bit	O	CR-T-	DPT_Heat_Cool	0/1	[Cx] Mode - Control	0 = Cool; 1 = Heat
1 Byte	O	CR-T-	DPT_HVACContrMode	0=Auto 1=Heat 3=Cool 9=Fan 14=Dry	[Cx] Mode - Control	Auto, Heat, Cool, Fan and Dry
1 Bit	O	CR-T-	DPT_Step	0/1	[Cx] Fan - Binary Control	0 = Decrease; 1 = Increase
1 Byte	O	CR-T-	DPT_Scaling	0% - 100%	[Cx] Fan - Percentage Control	100%

1 Byte	O	CR-T-	DPT_Scaling	0% - 100%	[Cx] Fan - Percentage Control	50%, 100%
1 Byte	O	CR-T-	DPT_Scaling	0% - 100%	[Cx] Fan - Percentage Control	33%, 67%, 100%
1 Byte	O	CR-T-	DPT_Scaling	0% - 100%	[Cx] Fan - Percentage Control	25%, 50%, 75%, 100%
1 Byte	O	CR-T-	DPT_Scaling	0% - 100%	[Cx] Fan - Percentage Control	20%, 40%, 60%, 80%, 100%
1 Byte	O	CR-T-	DPT_Scaling	0% - 100%	[Cx] Fan - Percentage Control	0%, 100%
1 Byte	O	CR-T-	DPT_Scaling	0% - 100%	[Cx] Fan - Percentage Control	0%, 50%, 100%
1 Byte	O	CR-T-	DPT_Scaling	0% - 100%	[Cx] Fan - Percentage Control	0%, 33%, 67%, 100%
1 Byte	O	CR-T-	DPT_Scaling	0% - 100%	[Cx] Fan - Percentage Control	0%, 25%, 50%, 75%, 100%
1 Byte	O	CR-T-	DPT_Scaling	0% - 100%	[Cx] Fan - Percentage Control	0%, 20%, 40%, 60%, 80%, 100%
1 Byte	O	CR-T-	DPT_Scaling	0% - 100%	[Cx] Fan - Percentage Control	Auto, 100%
1 Byte	O	CR-T-	DPT_Scaling	0% - 100%	[Cx] Fan - Percentage Control	Auto, 50%, 100%
1 Byte	O	CR-T-	DPT_Scaling	0% - 100%	[Cx] Fan - Percentage Control	Auto, 33%, 67%, 100%
1 Byte	O	CR-T-	DPT_Scaling	0% - 100%	[Cx] Fan - Percentage Control	Auto, 25%, 50%, 75%, 100%
1 Byte	O	CR-T-	DPT_Scaling	0% - 100%	[Cx] Fan - Percentage Control	Auto, 20%, 40%, 60%, 80%, 100%
1 Byte	O	CR-T-	DPT_Fan_Stage	0 - 255	[Cx] Fan - Enumeration Control	1
1 Byte	O	CR-T-	DPT_Fan_Stage	0 - 255	[Cx] Fan - Enumeration Control	1, 2
1 Byte	O	CR-T-	DPT_Fan_Stage	0 - 255	[Cx] Fan - Enumeration Control	1, 2, 3
1 Byte	O	CR-T-	DPT_Fan_Stage	0 - 255	[Cx] Fan - Enumeration Control	1, 2, 3, 4
1 Byte	O	CR-T-	DPT_Fan_Stage	0 - 255	[Cx] Fan - Enumeration Control	1, 2, 3, 4, 5
1 Byte	O	CR-T-	DPT_Fan_Stage	0 - 255	[Cx] Fan - Enumeration Control	0, 1
1 Byte	O	CR-T-	DPT_Fan_Stage	0 - 255	[Cx] Fan - Enumeration Control	0, 1, 2
1 Byte	O	CR-T-	DPT_Fan_Stage	0 - 255	[Cx] Fan - Enumeration Control	0, 1, 2, 3
1 Byte	O	CR-T-	DPT_Fan_Stage	0 - 255	[Cx] Fan - Enumeration Control	0, 1, 2, 3, 4
1 Byte	O	CR-T-	DPT_Fan_Stage	0 - 255	[Cx] Fan - Enumeration Control	0, 1, 2, 3, 4, 5
1 Byte	O	CR-T-	DPT_Fan_Stage	0 - 255	[Cx] Fan - Enumeration Control	Auto, 1
1 Byte	O	CR-T-	DPT_Fan_Stage	0 - 255	[Cx] Fan - Enumeration Control	Auto, 1, 2
1 Byte	O	CR-T-	DPT_Fan_Stage	0 - 255	[Cx] Fan - Enumeration Control	Auto, 1, 2, 3
1 Byte	O	CR-T-	DPT_Fan_Stage	0 - 255	[Cx] Fan - Enumeration Control	Auto, 1, 2, 3, 4
1 Byte	O	CR-T-	DPT_Fan_Stage	0 - 255	[Cx] Fan - Enumeration Control	Auto, 1, 2, 3, 4, 5
1 Byte	O	CR-T-	DPT_HVACMode	1=Comfort 2=Standby 3=Economy 4=Building Protection	[Cx] Special Mode - Control	Auto, Comfort, Standby, Economy and Building Protection
4 Bit	O	CR-T-	DPT_Control_Dimming	0x0/0x8 (Stop) 0x1...0x7 (Dec.) 0x9...0xF (Inc.)	[Cx] RGB - Light Dimming Control	4-Bit Dimming Control
1 Bit	I	C-WTU	DPT_Ack	0/1	[Cx] Alarm - Confirmation	0 = No Action; 1 = Confirm
1 Bit	I/O	CRWT U	DPT_Enable	0/1	[Cx] Chronothermostat - Enable	0 = Disable; 1 = Enable
1 Bit	I/O	CRWT U	DPT_Enable	0/1	[Cx] Chronothermostat - Enable	0 = Enable; 1 = Disable

	1 Bit	O	C--T-	DPT_Switch	0/1	[Cx] Macro - Notification Control	Macro execution notification
	1 Byte	O	C--T-	DPT_SceneNumber	0 - 63	[Cx] Macro - Notification Control	Macro execution notification
	1 Byte	I/O	CRWTU	DPT_Scaling	0% - 100%	[Cx] RGBW - Green Channel	0% ... 100%
	1 Bit	O	C--T-	DPT_Switch	0/1	[Cx] Timer - Switch Control	1-Bit Generic Control
	1 Byte	O	C--T-	DPT_SceneNumber	0 - 63	[Cx] Timer - Send Scene Control	0-63 (Run Scene 1-64)
	14 Bytes	O	CR-T-	DPT_String_UTF-8		[Cx] Keypad - Control	Numerical String
602, 608, 614, 620, 626, 632, 638, 644, 650, 656, 662, 668, 674, 680, 686	1 Bit	O	CR-T-	DPT_Switch	0/1	[Cx] Two Objects - Long Press Control: "0"	1-Bit Generic Control
	1 Bit	O	CR-T-	DPT_Switch	0/1	[Cx] Two Objects - Long Press Control: "1"	1-Bit Generic Control
	1 Bit	O	CR-T-	DPT_Switch	0/1	[Cx] Two Objects - Long Press Control: "0/1"	1-Bit Generic Control
	1 Byte	O	CR-T-	DPT_Value_1_Ucount	0 - 255	[Cx] Two Objects - Long Press Control: 1-Byte	Send Selected 1-Byte Value on Short Press
	1 Bit	O	CR-T-	DPT_Switch	0/1	[Cx] Two Objects - Long Press Control	1-Bit Generic Control
	1 Byte	O	C--T-	DPT_SceneNumber	0 - 63	[Cx] Two Scenes - Bottom Scene Send Control	0-63 (Run Scene 1-64)
	1 Byte	O	C--T-	DPT_SceneControl	0-63; 128-191	[Cx] Two Scenes - Bottom Scene Send Control	0-63/128-191 (Run/Save Scene 1-64)
	1 Bit	O	CR-T-	DPT_UpDown	0/1	[Cx] Shutter - Move Control	0 = Up; 1 = Down
	1 Bit	I/O	CRWTU	DPT_Enable	0/1	[Cx] Fan - Auto Mode	Switch Auto Mode on Short Press
	1 Bit	I/O	CRWTU	DPT_Enable	0/1	[Cx] Fan - Auto Mode	Switch Auto Mode on Long Press
	1 Byte	I/O	CRWTU	DPT_Scaling	0% - 100%	[Cx] RGB - Green Channel	0% ... 100%
	1 Bit	O	CR-T-	DPT_Switch	0/1	[Cx] Chronothermostat - On/Off Control	0 = Off; 1 = On
	1 Byte	O	CR-T-	DPT_Scaling	0% - 100%	[Cx] Light - 1-Byte Percentage Control (Only Schedulers, Macros and Voice Control)	1-Byte Dimmer Control
	1 Byte	I/O	CRWTU	DPT_Scaling	0% - 100%	[Cx] RGBW - Blue Channel	0% ... 100%
	603, 609, 615, 621, 627, 633, 639, 645, 651, 657, 663, 669, 675, 681, 687	4 Bit	O	CR-T-	DPT_Control_Dimming	0x0/0x8 (Stop) 0x1...0x7 (Dec.) 0x9...0xF (Inc.)	[Cx] Light - 4-bits Dimming Control
2 Bytes		I	C-WTU	DPT_Value_Temp	-273.00° - 670433.28°	[Cx] Setpoint - Ambient Temperature Status	-99°C ... 199°C

	1 Byte	I/O	CRWT U	DPT_Scaling	0% - 100%	[Cx] RGB - Blue Channel	0% ... 100%
	1 Byte	I/O	CRWT U	DPT_Scaling	0% - 100%	[Cx] RGBW - White Channel	0% ... 100%
	2 Bytes	O	CR-T-	DPT_Value_Temp	-273.00° - 670433.28°	[Cx] Chronothermostat - Setpoint Control	-99°C ... 199°C
	1 Byte	O	CR-T-	DPT_Scaling	0% - 100%	[Cx] Shutter - Percentage Control (Only Schedulers, Macros and Voice Control)	0% = Top; 100% = Bottom
	1 Byte	O	CR-T-	DPT_Scaling	0% - 100%	[Cx] Shutter - Percentage Control	0% = Top; 100% = Bottom
	2 Bytes	I	C-WTU	DPT_Absolute_Colour_Temperature	0 - 65535	[Cx] Light - Colour Temperature Status	1000K ... 20000K
604, 610, 616, 622, 628, 634, 640, 646, 652, 658, 664, 670, 676, 682, 688	4 Bit	O	CR-T-	DPT_Control_Dimming	0x0/0x8 (Stop) 0x1...0x7 (Dec.) 0x9...0xF (Inc.)	[Cx] RGBW - Light Dimming Control	4-Bit Dimming Control
	2 Bytes	O	CR-T-	DPT_Absolute_Colour_Temperature	0 - 65535	[Cx] Light - Colour Temperature Control	1000K ... 20000K
	1 Bit	I	C-WTU	DPT_Heat_Cool	0/1	[Cx] Setpoint - Mode Status	0 = Cool; 1 = Heat
605, 611, 617, 623, 629, 635, 641, 647, 653, 659, 665, 671, 677, 683, 689	1 Bit	I/O	CRWT U	DPT_Switch	0/1	[Cx] RGBW - On/Off	0 = Off; 1 = On
	1 Bit	I/O	CRWT U	DPT_Switch	0/1	[Cx] RGB - On/Off	0 = Off; 1 = On
1680	1 Bit	O	C--T-	DPT_Ack	0/1	[Sunrise/Sunset] Event at Sunrise	Send 0 at Sunrise
	1 Bit	O	C--T-	DPT_Ack	0/1	[Sunrise/Sunset] Event at Sunrise	Send 1 at Sunrise
1681	1 Bit	O	C--T-	DPT_Ack	0/1	[Sunrise/Sunset] Event at Sunset	Send 0 at Sunset
	1 Bit	O	C--T-	DPT_Ack	0/1	[Sunrise/Sunset] Event at Sunset	Send 1 at Sunset
1682	1 Bit	I	C-W--	DPT_DayNight	0/1	[General] Backlight Mode	0 = Night Mode; 1 = Normal Mode
	1 Bit	I	C-W--	DPT_DayNight	0/1	[General] Backlight Mode	0 = Normal Mode; 1 = Night Mode
1683	1 Byte	I	C-W--	DPT_Scaling	0% - 100%	[Profile] Display - Brightness	0% ... 100%
1684	1 Byte	I	C-W--	DPT_Scaling	0% - 100%	[General] Display - Contrast	0% ... 100%
1685	1 Bit	O	C--T-	DPT_Trigger	0/1	[Heartbeat] Object to Send '1'	Sending of '1' Periodically
1686	1 Bit	O	C--T-	DPT_Trigger	0/1	[Heartbeat] Device Recovery	Send 0
1687	1 Bit	O	C--T-	DPT_Trigger	0/1	[Heartbeat] Device Recovery	Send 1
1688	1 Bit	I	C-W--	DPT_Enable	0/1	[General] Proximity Sensor	0 = Disable; 1 = Enable
1689	1 Bit	I	C-W--	DPT_Start	0/1	[General] External Proximity Detection	1 = Detection
1690	1 Bit	O	C--T-	DPT_Start	0/1	[General] Proximity Detection	Send 1 when Proximity is Detected
1691	1 Bit	O	C--T-	DPT_Bool	0/1	[General] Luminosity (1-Bit)	0 = Over Threshold; 1 = Under Threshold
	1 Bit	O	C--T-	DPT_Bool	0/1	[General] Luminosity (1-Bit)	0 = Under Threshold; 1 = Over Threshold
1692	1 Byte	O	CR---	DPT_Scaling	0% - 100%	[General] Luminosity (Percentage)	0% ... 100%

1693	2 Bytes	O	CR---	DPT_Value_Lux		[General] Luminosity (Lux)	0 Lux ... 670760 Lux
1694, 1700, 1706, 1712	1 Bit	I	C-W--	DPT_Enable	0/1	[Ix] Input Lock	0 = Unlock; 1 = Lock
1695, 1701, 1707, 1713	1 Bit	O	C--T-	DPT_Switch	0/1	[Ix] [Short Press] 0	Sending of 0
	1 Bit	O	C--T-	DPT_Switch	0/1	[Ix] [Short Press] 1	Sending of 1
	1 Bit	I	C-WT-	DPT_Switch	0/1	[Ix] [Short Press] 0/1 Switching	Switching 0/1
	1 Bit	O	C--T-	DPT_UpDown	0/1	[Ix] [Short Press] Move Up Shutter	Sending of 0 (Up)
	1 Bit	O	C--T-	DPT_UpDown	0/1	[Ix] [Short Press] Move Down Shutter	Sending of 1 (Down)
	1 Bit	O	C--T-	DPT_UpDown	0/1	[Ix] [Short Press] Move Up/Down Shutter	Switching 0/1 (Up/Down)
	1 Bit	O	C--T-	DPT_Step	0/1	[Ix] [Short Press] Stop/Step Up Shutter	Sending of 0 (Stop/Step Up)
	1 Bit	O	C--T-	DPT_Step	0/1	[Ix] [Short Press] Stop/Step Down Shutter	Sending of 1 (Stop/Step Down)
	1 Bit	O	C--T-	DPT_Step	0/1	[Ix] [Short Press] Stop/Step Shutter (Switched)	Switching of 0/1 (Stop/Step Up/Down)
	4 Bit	O	C--T-	DPT_Control_Dimming	0x0/0x8 (Stop) 0x1...0x7 (Dec.) 0x9...0xF (Inc.)	[Ix] [Short Press] Brighter	Increase Brightness
	4 Bit	O	C--T-	DPT_Control_Dimming	0x0/0x8 (Stop) 0x1...0x7 (Dec.) 0x9...0xF (Inc.)	[Ix] [Short Press] Darker	Decrease Brightness
	4 Bit	O	C--T-	DPT_Control_Dimming	0x0/0x8 (Stop) 0x1...0x7 (Dec.) 0x9...0xF (Inc.)	[Ix] [Short Press] Brighter/Darker	Switch Bright/Dark
	1 Bit	O	C--T-	DPT_Switch	0/1	[Ix] [Short Press] Light On	Sending of 1 (On)
	1 Bit	O	C--T-	DPT_Switch	0/1	[Ix] [Short Press] Light Off	Sending of 0 (Off)
	1 Bit	I	C-WT-	DPT_Switch	0/1	[Ix] [Short Press] Light On/Off	Switching 0/1
	1 Byte	O	C--T-	DPT_SceneControl	0-63; 128-191	[Ix] [Short Press] Run Scene	Sending of 0 - 63
	1 Byte	O	C--T-	DPT_SceneControl	0-63; 128-191	[Ix] [Short Press] Save Scene	Sending of 128 - 191
	1 Bit	I/O	CRWT-	DPT_Switch	0/1	[Ix] [Switch/Sensor] Edge	Sending of 0 or 1
	1 Byte	O	C--T-	DPT_Value_1_Ucount	0 - 255	[Ix] [Short Press] Constant Value (Integer)	0 - 255
	1 Byte	O	C--T-	DPT_Scaling	0% - 100%	[Ix] [Short Press] Constant Value (Percentage)	0% - 100%
2 Bytes	O	C--T-	DPT_Value_2_Ucount	0 - 65535	[Ix] [Short Press] Constant Value (Integer)	0 - 65535	
2 Bytes	O	C--T-	9.xxx	-671088.64 - 670433.28	[Ix] [Short Press] Constant Value (Float)	Float Value	
1696, 1702, 1708, 1714	1 Byte	I	C-W--	DPT_Scaling	0% - 100%	[Ix] [Short Press] Shutter Status (Input)	0% = Top; 100% = Bottom

	1 Byte	I	C - W - -	DPT_Scaling	0% - 100%	[Ix] [Short Press] Dimming Status (Input)	0% - 100%
1697, 1703, 1709, 1715	1 Bit	O	C - - - T -	DPT_Switch	0/1	[Ix] [Long Press] 0	Sending of 0
	1 Bit	O	C - - - T -	DPT_Switch	0/1	[Ix] [Long Press] 1	Sending of 1
	1 Bit	I	C - W T -	DPT_Switch	0/1	[Ix] [Long Press] 0/1 Switching	Switching 0/1
	1 Bit	O	C - - - T -	DPT_UpDown	0/1	[Ix] [Long Press] Move Up Shutter	Sending of 0 (Up)
	1 Bit	O	C - - - T -	DPT_UpDown	0/1	[Ix] [Long Press] Move Down Shutter	Sending of 1 (Down)
	1 Bit	O	C - - - T -	DPT_UpDown	0/1	[Ix] [Long Press] Move Up/Down Shutter	Switching 0/1 (Up/Down)
	1 Bit	O	C - - - T -	DPT_Step	0/1	[Ix] [Long Press] Stop/Step Up Shutter	Sending of 0 (Stop/Step Up)
	1 Bit	O	C - - - T -	DPT_Step	0/1	[Ix] [Long Press] Stop/Step Down Shutter	Sending of 1 (Stop/Step Down)
	1 Bit	O	C - - - T -	DPT_Step	0/1	[Ix] [Long Press] Stop/Step Shutter (Switched)	Switching of 0/1 (Stop/Step Up/Down)
	4 Bit	O	C - - - T -	DPT_Control_Dimming	0x0/0x8 (Stop) 0x1...0x7 (Dec.) 0x9...0xF (Inc.)	[Ix] [Long Press] Brighter	Long Pr. -> Brighter; Release -> Stop
	4 Bit	O	C - - - T -	DPT_Control_Dimming	0x0/0x8 (Stop) 0x1...0x7 (Dec.) 0x9...0xF (Inc.)	[Ix] [Long Press] Darker	Long Pr. -> Darker; Release -> Stop
	4 Bit	O	C - - - T -	DPT_Control_Dimming	0x0/0x8 (Stop) 0x1...0x7 (Dec.) 0x9...0xF (Inc.)	[Ix] [Long Press] Brighter/Darker	Long Pr. -> Brighter/Darker; Release -> Stop
	1 Bit	O	C - - - T -	DPT_Switch	0/1	[Ix] [Long Press] Light On	Sending of 1 (On)
	1 Bit	O	C - - - T -	DPT_Switch	0/1	[Ix] [Long Press] Light Off	Sending of 0 (Off)
	1 Bit	I	C - W T -	DPT_Switch	0/1	[Ix] [Long Press] Light On/Off	Switching 0/1
	1 Byte	O	C - - - T -	DPT_SceneControl	0-63; 128-191	[Ix] [Long Press] Run Scene	Sending of 0 - 63
	1 Byte	O	C - - - T -	DPT_SceneControl	0-63; 128-191	[Ix] [Long Press] Save Scene	Sending of 128 - 191
	1 Bit	O	C R - T -	DPT_Alarm	0/1	[Ix] [Switch/Sensor] Alarm: Breakdown or Sabotage	1 = Alarm; 0 = No Alarm
	2 Bytes	O	C - - - T -	9.xxx	-671088.64 - 670433.28	[Ix] [Long Press] Constant Value (Float)	Float Value
2 Bytes	O	C - - - T -	DPT_Value_2_Ucount	0 - 65535	[Ix] [Long Press] Constant Value (Integer)	0 - 65535	
1 Byte	O	C - - - T -	DPT_Scaling	0% - 100%	[Ix] [Long Press] Constant Value (Percentage)	0% - 100%	
1 Byte	O	C - - - T -	DPT_Value_1_Ucount	0 - 255	[Ix] [Long Press] Constant Value (Integer)	0 - 255	
1698, 1704, 1710, 1716	1 Bit	O	C - - - T -	DPT_Trigger	0/1	[Ix] [Long Press/Release] Stop Shutter	Release -> Stop Shutter
1699, 1705, 1711, 1717	1 Byte	I	C - W - -	DPT_Scaling	0% - 100%	[Ix] [Long Press] Dimming Status (Input)	0% - 100%

	1 Byte	I	C - W - -	DPT_Scaling	0% - 100%	[Ix] [Long Press] Shutter Status (Input)	0% = Top; 100% = Bottom
1718	1 Byte	I	C - W - -	DPT_SceneNumber	0 - 63	[Motion Detector] Scene Input	Scene Value
1719	1 Byte	O	C - - T -	DPT_SceneControl	0-63; 128-191	[Motion Detector] Scene Output	Scene Value
1720, 1754, 1788, 1822	1 Byte	O	C R - T -	DPT_Scaling	0% - 100%	[Ix] Luminosity	0-100%
1721, 1755, 1789, 1823	1 Bit	O	C R - T -	DPT_Alarm	0/1	[Ix] Open Circuit Error	0 = No Error; 1 = Open Circuit Error
1722, 1756, 1790, 1824	1 Bit	O	C R - T -	DPT_Alarm	0/1	[Ix] Short Circuit Error	0 = No Error; 1 = Short Circuit Error
1723, 1757, 1791, 1825	1 Byte	O	C R - T -	DPT_Scaling	0% - 100%	[Ix] Presence State (Scaling)	0-100%
1724, 1758, 1792, 1826	1 Byte	O	C R - T -	DPT_HVACMode	1=Comfort 2=Standby 3=Economy 4=Building Protection	[Ix] Presence State (HVAC)	Auto, Comfort, Standby, Economy, Building Protection
1725, 1759, 1793, 1827	1 Bit	O	C R - T -	DPT_Switch	0/1	[Ix] Presence State (Binary)	Binary Value
	1 Bit	O	C R - T -	DPT_Start	0/1	[Ix] Presence: Slave Output	1 = Motion Detected
1726, 1760, 1794, 1828	1 Bit	I	C - W - -	DPT_Window_Door	0/1	[Ix] Presence Trigger	Binary Value to Trigger the Presence Detection
1727, 1761, 1795, 1829	1 Bit	I	C - W - -	DPT_Start	0/1	[Ix] Presence: Slave Input	0 = Nothing; 1 = Detection from slave device
1728, 1762, 1796, 1830	2 Bytes	I/O	C R W - -	DPT_TimePeriodSec	0 - 65535	[Ix] Presence: Waiting Time	0-65535 s.
1729, 1763, 1797, 1831	2 Bytes	I/O	C R W - -	DPT_TimePeriodSec	0 - 65535	[Ix] Presence: Listening Time	1-65535 s.
1730, 1764, 1798, 1832	2 Bytes	I/O	C R W - -	DPT_TimePeriodMin	0 - 65535	[Ix] Presence: Safety Time	0-1440 min.
1731, 1765, 1799, 1833	1 Byte	I/O	C R W - -	DPT_Value_1_Ucount	0 - 255	[Ix] Presence: Filter Detections Number	2-5
1732, 1766, 1800, 1834	1 Byte	I/O	C R W - -	DPT_Value_1_Ucount	0 - 255	[Ix] Presence: Filter Detection Window	15-60 s.
1733, 1767, 1801, 1835	1 Bit	I	C - W - -	DPT_Enable	0/1	[Ix] Presence: Enable	According to parameters
1734, 1768, 1802, 1836	1 Bit	I/O	C R W - -	DPT_DayNight	0/1	[Ix] Presence: Day/Night	According to parameters
1735, 1769, 1803, 1837	1 Bit	O	C R - T -	DPT_Occupancy	0/1	[Ix] Presence: Occupancy State (Master Output)	0 = Not Occupied; 1 = Occupied
	1 Bit	I	C - W - -	DPT_Occupancy	0/1	[Ix] Presence: Occupancy State (Master Input)	0 = Not Occupied; 1 = Occupied
1736, 1770, 1804, 1838	1 Bit	I	C - W - -	DPT_Switch	0/1	[Ix] Presence: Access Guest/Employee	0 = Guest; 1 = Employee

	1 Bit	I	C - W - -	DPT_Switch	0/1	[Ix] Presence: Access Guest/Employee	0 = Employee; 1 = Guest
1737, 1771, 1805, 1839	1 Bit	I	C - W - -	DPT_Boot	0/1	[Ix] Presence: Sold/Unsold Room	0 = Unsold; 1 = Sold
	1 Bit	I	C - W - -	DPT_Boot	0/1	[Ix] Presence: Sold/Unsold Room	0 = Sold; 1 = Unsold
1738, 1772, 1806, 1840	1 Bit	I	C - W - -	DPT_Start	0/1	[Ix] External Motion Detection	0 = Nothing; 1 = Motion detected by an external sensor
1739, 1744, 1749, 1773, 1778, 1783, 1807, 1812, 1817, 1841, 1846, 1851	1 Byte	O	C R - T -	DPT_Scaling	0% - 100%	[Ix] [Cx] Detection State (Scaling)	0-100%
1740, 1745, 1750, 1774, 1779, 1784, 1808, 1813, 1818, 1842, 1847, 1852	1 Byte	O	C R - T -	DPT_HVACMode	1=Comfort 2=Standby 3=Economy 4=Building Protection	[Ix] [Cx] Detection State (HVAC)	Auto, Comfort, Standby, Economy, Building Protection
1741, 1746, 1751, 1775, 1780, 1785, 1809, 1814, 1819, 1843, 1848, 1853	1 Bit	O	C R - T -	DPT_Switch	0/1	[Ix] [Cx] Detection State (Binary)	Binary Value
1742, 1747, 1752, 1776, 1781, 1786, 1810, 1815, 1820, 1844, 1849, 1854	1 Bit	I	C - W - -	DPT_Enable	0/1	[Ix] [Cx] Enable Channel	According to parameters
1743, 1748, 1753, 1777, 1782, 1787, 1811, 1816, 1821, 1845, 1850, 1855	1 Bit	I	C - W - -	DPT_Switch	0/1	[Ix] [Cx] Force State	0 = No Detection; 1 = Detection
1856	2 Bytes	O	C R - T -	DPT_Value_Temp	-273.00° - 670433.28°	[Internal Temp. Probe] Current Temperature	Temperature Sensor Value
1857	1 Bit	O	C R - T -	DPT_Alarm	0/1	[Internal Temp. Probe] Overcooling	0 = No Alarm; 1 = Alarm
1858	1 Bit	O	C R - T -	DPT_Alarm	0/1	[Internal Temp. Probe] Overheating	0 = No Alarm; 1 = Alarm
1859, 1863, 1867, 1871	2 Bytes	O	C R - T -	DPT_Value_Temp	-273.00° - 670433.28°	[Ix] Current Temperature	Temperature Sensor Value
1860, 1864, 1868, 1872	1 Bit	O	C R - T -	DPT_Alarm	0/1	[Ix] Overcooling	0 = No Alarm; 1 = Alarm
1861, 1865, 1869, 1873	1 Bit	O	C R - T -	DPT_Alarm	0/1	[Ix] Overheating	0 = No Alarm; 1 = Alarm
1862, 1866, 1870, 1874	1 Bit	O	C R - T -	DPT_Alarm	0/1	[Ix] Probe Error	0 = No Alarm; 1 = Alarm
1875	1 Byte	I	C - W - -	DPT_SceneControl	0-63; 128-191	[Thermostat] Scenes	0 - 63 (Execute 1 - 64); 128 - 191 (Save 1 - 64)
1876, 1914	2 Bytes	I	C - W T U	DPT_Value_Temp	-273.00° - 670433.28°	[Tx] Temperature Source 1	External Sensor Temperature

1877, 1915	2 Bytes	I	C - W T U	DPT_Value_Temp	-273.00° - 670433.28°	[Tx] Temperature Source 2	External Sensor Temperature
1878, 1916	2 Bytes	O	C R - T -	DPT_Value_Temp	-273.00° - 670433.28°	[Tx] Effective Temperature	Effective Control Temperature
1879, 1917	1 Byte	I	C - W - -	DPT_HVACMode	1=Comfort 2=Standby 3=Economy 4=Building Protection	[Tx] Special Mode	1-Byte HVAC Mode
1880, 1918	1 Bit	I	C - W - -	DPT_Ack	0/1	[Tx] Special Mode: Comfort	0 = Nothing; 1 = Trigger
	1 Bit	I	C - W - -	DPT_Switch	0/1	[Tx] Special Mode: Comfort	0 = Off; 1 = On
1881, 1919	1 Bit	I	C - W - -	DPT_Ack	0/1	[Tx] Special Mode: Standby	0 = Nothing; 1 = Trigger
	1 Bit	I	C - W - -	DPT_Switch	0/1	[Tx] Special Mode: Standby	0 = Off; 1 = On
1882, 1920	1 Bit	I	C - W - -	DPT_Ack	0/1	[Tx] Special Mode: Economy	0 = Nothing; 1 = Trigger
	1 Bit	I	C - W - -	DPT_Switch	0/1	[Tx] Special Mode: Economy	0 = Off; 1 = On
1883, 1921	1 Bit	I	C - W - -	DPT_Ack	0/1	[Tx] Special Mode: Protection	0 = Nothing; 1 = Trigger
	1 Bit	I	C - W - -	DPT_Switch	0/1	[Tx] Special Mode: Protection	0 = Off; 1 = On
1884, 1922	1 Bit	I	C - W - -	DPT_Window_Door	0/1	[Tx] Window Status (Input)	0 = Closed; 1 = Open
1885, 1923	1 Bit	I	C - W - -	DPT_Trigger	0/1	[Tx] Comfort Prolongation	0 = Nothing; 1 = Timed Comfort
1886, 1924	1 Byte	O	C R - T -	DPT_HVACMode	1=Comfort 2=Standby 3=Economy 4=Building Protection	[Tx] Special Mode Status	1-Byte HVAC Mode
1887, 1925	2 Bytes	I	C - W - -	DPT_Value_Temp	-273.00° - 670433.28°	[Tx] Setpoint	Thermostat Setpoint Input
	2 Bytes	I	C - W - -	DPT_Value_Temp	-273.00° - 670433.28°	[Tx] Basic Setpoint	Reference Setpoint
1888, 1926	1 Bit	I	C - W - -	DPT_Step	0/1	[Tx] Setpoint Step	0 = Decrease Setpoint; 1 = Increase Setpoint
1889, 1927	2 Bytes	I	C - W - -	DPT_Value_Tempd	-671088.64° - 670433.28°	[Tx] Setpoint Offset	Float Offset Value
1890, 1928	2 Bytes	O	C R - T -	DPT_Value_Temp	-273.00° - 670433.28°	[Tx] Setpoint Status	Current Setpoint
1891, 1929	2 Bytes	O	C R - T -	DPT_Value_Temp	-273.00° - 670433.28°	[Tx] Basic Setpoint Status	Current Basic Setpoint
1892, 1930	2 Bytes	O	C R - T -	DPT_Value_Tempd	-671088.64° - 670433.28°	[Tx] Setpoint Offset Status	Current Setpoint Offset
1893, 1931	1 Bit	I	C - W - -	DPT_Reset	0/1	[Tx] Setpoint Reset	Reset Setpoint to Default
	1 Bit	I	C - W - -	DPT_Reset	0/1	[Tx] Offset Reset	Reset Offset
1894, 1932	1 Bit	I	C - W - -	DPT_Heat_Cool	0/1	[Tx] Mode	0 = Cool; 1 = Heat
1895, 1933	1 Bit	O	C R - T -	DPT_Heat_Cool	0/1	[Tx] Mode Status	0 = Cool; 1 = Heat
1896, 1934	1 Bit	I	C - W - -	DPT_Switch	0/1	[Tx] On/Off	0 = Off; 1 = On

1897, 1935	1 Bit	O	CR-T-	DPT_Switch	0/1	[Tx] On/Off Status	0 = Off; 1 = On
1898, 1936	1 Bit	I/O	CRW--	DPT_Switch	0/1	[Tx] Main System (Cool)	0 = System 1; 1 = System 2
1899, 1937	1 Bit	I/O	CRW--	DPT_Switch	0/1	[Tx] Main System (Heat)	0 = System 1; 1 = System 2
1900, 1938	1 Bit	I	C-W--	DPT_Enable	0/1	[Tx] Enable/Disable Secondary System (Cool)	0 = Disable; 1 = Enable
1901, 1939	1 Bit	I	C-W--	DPT_Enable	0/1	[Tx] Enable/Disable Secondary System (Heat)	0 = Disable; 1 = Enable
1902, 1908, 1940, 1946	1 Byte	O	CR-T-	DPT_Scaling	0% - 100%	[Tx] [Sx] Control Variable (Cool)	PI Control (Continuous)
1903, 1909, 1941, 1947	1 Byte	O	CR-T-	DPT_Scaling	0% - 100%	[Tx] [Sx] Control Variable (Heat)	PI Control (Continuous)
	1 Byte	O	CR-T-	DPT_Scaling	0% - 100%	[Tx] [Sx] Control Variable	PI Control (Continuous)
1904, 1910, 1942, 1948	1 Bit	O	CR-T-	DPT_Switch	0/1	[Tx] [Sx] Control Variable (Cool)	2-Point Control
	1 Bit	O	CR-T-	DPT_Switch	0/1	[Tx] [Sx] Control Variable (Cool)	PI Control (PWM)
1905, 1911, 1943, 1949	1 Bit	O	CR-T-	DPT_Switch	0/1	[Tx] [Sx] Control Variable (Heat)	2-Point Control
	1 Bit	O	CR-T-	DPT_Switch	0/1	[Tx] [Sx] Control Variable (Heat)	PI Control (PWM)
	1 Bit	O	CR-T-	DPT_Switch	0/1	[Tx] [Sx] Control Variable	2-Point Control
	1 Bit	O	CR-T-	DPT_Switch	0/1	[Tx] [Sx] Control Variable	PI Control (PWM)
1906, 1912, 1944, 1950	1 Bit	O	CR-T-	DPT_Switch	0/1	[Tx] [Sx] PI State (Cool)	0 = PI Signal 0%; 1 = PI Signal Greater than 0%
1907, 1913, 1945, 1951	1 Bit	O	CR-T-	DPT_Switch	0/1	[Tx] [Sx] PI State (Heat)	0 = PI Signal 0%; 1 = PI Signal Greater than 0%
	1 Bit	O	CR-T-	DPT_Switch	0/1	[Tx] [Sx] PI State	0 = PI Signal 0%; 1 = PI Signal Greater than 0%

Join and send us your inquiries
about Zennio devices:

<https://support.zennio.com>

Zennio Avance y Tecnología S.L.

C/ Río Jarama, 132. Nave P-8.11

45007 Toledo, Spain.

Tel. +34 925 232 002.

www.zennio.com

info@zennio.com